

GOBIERNO AUTÓNOMO DESCENTRALIZADO DE LA PROVINCIA DEL PASTAZA

PROYECTO " CONSTRUCCIÓN DE LOS HANGARES DEL GOBIERNO AUTÓNOMO DESCENTRALIZADO PROVINCIAL DE PASTAZA (GADPP2) I ETAPA, PARROQUIA FÁTIMA, CANTÓN Y PROVINCIA DE PASTAZA "

PLANILLA DE AVANCE DE OBRA No. 23

RUBRO N° 23
DESCRIPCIÓN: DESALOJO MECANICO VOLQUETA TIERRA/ESCOMBROS
UNIDAD: m3
PERIODO: 01-jun 30-jun

ANEXO 1



PAG. 1 DE 3

DESALOJO MECANICO VOLQUETA TIERRA/ESCOMBROS

VOLUMEN DE DESALOJO						VOLUMEN DE DESALOJO					
DESALOJO DEL PARQUEADERO						DESALOJO DE LA VIA DE LA PARADA DE BUS 1					
ABCSISAS	AREA PARCIAL	AREA MEDIA	DISTANCIA	VOLUMEN PARCIAL	VOLUMEN ACUMULADO	ABCSISAS	AREA PARCIAL	AREA MEDIA	DISTANCIA	VOLUMEN PARCIAL	VOLUMEN ACUMULADO
0+000	21,05					0+000	8,33				
		20,25	9,97	202,52	202,52			8,26	10,00	0,00	0,00
0+010	19,45					0+010	8,19				
		17,47	10,00	174,68	377,20			8,19	10,00	81,62	81,62
0+020	15,48					0+020	8,19				
		13,60	10,00	136,01	513,21			8,19	10,00	81,89	163,51
0+030	11,72					0+030	8,19				
		10,53	10,00	105,27	618,48			9,33	6,76	81,89	245,40
0+040	9,34					0+037	10,47				
		9,10	10,00	91,00	709,48			5,24	-36,76	63,03	308,43
0+050	8,86										
		10,56	10,00	105,63	815,11						
0+060	12,26										
		11,92	10,00	88,88	903,99						
0+070	11,58										
		9,85	10,00	50,88	954,87						
0+080	8,12					0+000	2,60				
		6,60	10,00	66,02	1.020,89			2,53	10,00	0,00	0,00
0+090	5,08					0+010	2,46				
		5,75	7,18	41,30	1.062,19			2,46	10,00	25,30	25,30
0+097	6,42					0+020	2,46				
		9,17	1,27	20,31	1.082,50			2,57	10,00	24,60	49,90
0+098	11,91					0+030	2,67				
		8,76	1,26	19,13	1.101,63			2,88	1,03	25,65	75,55
0+100	5,60					0+031	3,08				
		3,87	1,90	10,55	1.112,18			1,54	-31,03	2,96	78,51
0+102	2,13										
		1,24	4,16	5,60	1.117,78						
0+106	0,35										

RESUMEN	
DESALOJO DEL PARQUEADERO	1.117,78
DESALOJO DE LA VIA DE LA PARADA DE BUS 1	308,43
DESALOJO DE LA ACERA DE LA PARADA DE BUS 1	78,51
EXCAVACION DE LA VIA DE LA PARADA DE BUS 2	152,57
EXCAVACION DE LA ACERA DE LA PARADA DE BUS 2	213,39
TOTAL	1.870,68

RESUMEN DE PLANILLA DE INCREMENTOS						
DESCRIPCION	CONTRATADO	ANTERIOR	ACTUAL	INCR. ANT.	INCR. ACT.	UNIDAD
DESALOJO MECANICO VOLQUETA TIERRA/ESCOMBROS	85.716,60	106.119,24			1.870,68	m3

CONTRATISTA

FISCALIZACIÓN

GOBIERNO AUTÓNOMO DESCENTRALIZADO DE LA PROVINCIA DEL PASTAZA

PROYECTO

" CONSTRUCCIÓN DE LOS HANGARES DEL GOBIERNO AUTÓNOMO DESCENTRALIZADO PROVINCIAL DE PASTAZA (GADPPZ) I ETAPA, PARROQUIA FÁTIMA, CANTÓN Y PROVINCIA DE PASTAZA "

PLANILLA DE AVANCE DE OBRA No. 23

RUBRO N° 23
DESCRIPCIÓN: DESALOJO MECANICO VOLQUETA TIERRA/ESCOMBROS
UNIDAD: m3
PERIODO: 01-jun 30-jun

ANEXO 2



PAG. 2 DE 3

DESALOJO MECANICO VOLQUETA TIERRA/ESCOMBROS

VOLUMEN DE DESALOJO

VOLUMEN DE DESALOJO

DESALOJO DE LA VIA DE LA PARADA DE BUS 2

ABCSISAS	AREA PARCIAL	AREA MEDIA	DISTANCIA	VOLUMEN PARCIAL	VOLUMEN ACUMULADO	ABCSISAS	AREA PARCIAL	AREA MEDIA	DISTANCIA	VOLUMEN PARCIAL	VOLUMEN ACUMULADO
0+000		0,00	0,00	0,00	0,00	0+000	2,72				
0+000	0,00					0+000	3,09	2,91	0,00	2,47	30,84
0+000		0,10	0,00	0,10	0,10	0+000	3,16	3,13	0,00	2,91	33,75
0+000	0,20					0+000	3,16	3,23	0,00	3,12	36,87
0+000		0,30	0,00	0,30	0,40	0+000	3,30				
0+000	0,39					0+000	3,30	3,42	0,00	3,23	40,10
0+000		0,49	0,00	0,49	0,89	0+000	3,54				
0+000	0,58					0+000	3,54	3,65	0,00	3,42	43,52
0+000		0,67	0,00	0,67	1,56	0+000	3,75				
0+000	0,76					0+000	3,75	3,82	0,00	3,64	47,16
0+000		0,86	0,00	0,86	2,42	0+000	3,89				
0+000	0,96					0+000	3,89	3,93	0,00	3,82	50,98
0+000		1,07	0,00	1,07	3,49	0+000	3,96				
0+000	1,18					0+000	3,96	3,96	0,00	3,93	54,91
0+000		1,17	0,00	1,17	4,66	0+000	3,95				
0+000	1,16					0+000	3,95	3,91	0,00	3,97	58,88
0+000		1,14	0,00	1,13	5,79	0+000	3,86				
0+000	1,11					0+000	3,86	3,84	0,00	3,96	62,84
0+000		1,08	0,00	1,08	6,87	0+000	3,82				
0+000	1,04					0+000	3,82	3,97	0,00	3,90	66,74
0+000		1,00	0,00	1,00	7,87	0+000	4,11				
0+000	0,96					0+000	4,11	4,37	0,00	3,84	70,58
0+000		1,03	0,00	1,03	8,90	0+000	4,63				
0+000	1,10					0+000	4,63	4,67	0,00	3,97	74,55
0+000		1,20	0,00	1,20	10,10	0+000	4,71				
0+000	1,30					0+000	4,71	4,65	0,34	4,37	78,92
0+000		1,41	0,00	1,41	11,51	0+000	4,59				
0+000	1,51					0+000	4,59	2,30	-0,38	4,67	83,59
0+000		1,59	0,00	1,58	13,09	0+000	1,66				
0+000	1,66					0+000	1,66	1,67	0,01	4,65	88,24
0+000		1,67	0,00	1,67	14,76	0+000	1,68				
0+000	1,68					0+000	1,68	1,69	0,01	4,53	92,77
0+000		1,69	0,14	0,27	15,03	0+000	1,70				
0+000	1,70					0+000	1,70	1,71	0,01	4,39	97,16
0+000		1,71	-0,13	0,44	15,47	0+000	1,71				
0+000	1,71					0+000	1,71	1,73	0,01	4,22	101,38
0+000		1,73	0,00	0,11	15,58	0+000	1,75				
0+000	1,75					0+000	1,75	1,79	0,01	4,01	105,39
0+000		1,79	0,00	0,35	15,93	0+000	1,82				
0+000	1,82					0+000	1,82	0,91	-0,44	3,76	109,15
0+000		0,91	-0,02	0,86	16,79	0+000	1,93				
0+000	1,93					0+000	1,93	1,96	0,01	1,05	110,20
0+000		1,96	0,00	1,88	18,67	0+000	1,98				
0+000	1,98					0+000	1,98	1,97	0,00	1,88	112,08
0+000		1,97	0,00	1,95	20,62	0+000	1,96				
0+000	1,96					0+000	1,96	1,92	0,01	2,00	114,08
0+000		1,92	0,00	1,97	22,59	0+000	1,87				
0+000	1,87					0+000	1,87	1,85	0,00	0,50	114,58
0+000		1,85	0,00	1,91	24,50	0+000	1,82				
0+000	1,82					0+000	1,82	2,02	0,01	2,28	116,86
0+000		2,02	0,00	1,85	26,35	0+000	2,21				
0+000	2,21					0+000	2,21	1,11	-0,48	0,65	117,51
0+000		1,11	-0,02	2,02	28,37						

CONTRATISTA

FISCALIZACIÓN

GOBIERNO AUTÓNOMO DESCENTRALIZADO DE LA PROVINCIA DEL PASTAZA

PROYECTO " CONSTRUCCIÓN DE LOS HANGARES DEL GOBIERNO AUTÓNOMO DESCENTRALIZADO PROVINCIAL DE PASTAZA (GADPPz) I ETAPA, PARROQUIA FÁTIMA, PLANILLA DE AVANCE DE OBRA No. 23

RUBRO N° 2 ANEXO 3
 DESCRIPCIÓN: DESALOJO MECANICO VOLQUETA TIERRA/ESCOMBROS
 UNIDAD: m3
 PERIODO: 01-jun 30-jun



PAG. 3 DE 3

DESALOJO MECANICO VOLQUETA TIERRA/ESCOMBROS

VOLUMEN DE DESALOJO						VOLUMEN DE DESALOJO					
						DESALOJO DE LA ACERA DE LA PARADA DE BUS 2					
ABCSISAS	AREA PARCIAL	AREA MEDIA	DISTANCIA	VOLUMEN PARCIAL	VOLUMEN ACUMULADO	ABCSISAS	AREA PARCIAL	AREA MEDIA	DISTANCIA	VOLUMEN PARCIAL	VOLUMEN ACUMULADO
0+000		0,00	0,00	2,18	119,69	0+000	21,05				
0+000	0,00					0+010	19,45	20,25	10,00	0,00	0,00
0+000	0,20	0,10	0,00	3,55	123,24	0+020	15,48	17,47	10,00	25,74	25,74
0+000	0,39	0,30	0,00	3,96	127,20	0+030	11,72	13,60	10,00	59,29	85,03
0+000		0,49	0,00	3,84	131,04	0+040	9,34	10,53	10,00	68,94	153,97
0+000	0,58	0,67	0,00	3,53	134,57	0+045	8,86	9,10	5,05	51,26	205,23
0+000	0,76	0,86	0,00	3,37	137,94			4,43	-45,05	8,16	213,39
0+000	0,96	1,07	0,00	3,17	141,11						
0+000	1,18	1,17	0,00	2,96	144,07						
0+000	1,16	1,14	0,00	2,71	146,78						
0+000	1,11	1,08	0,00	2,27	149,05						
0+000	1,04	1,00	0,00	1,64	150,69						
0+000	0,96	1,03	0,00	1,02	151,71						
0+000	1,10	1,20	0,00	0,57	152,28						
0+000	1,30	1,30	0,00	0,26	152,54						
0+000	1,30	0,65	-0,06	0,03	152,57						

CONTRATISTA

FISCALIZACIÓN

" CONSTRUCCIÓN DE LOS HANGARES DEL GOBIERNO AUTÓNOMO DESCENTRALIZADO PROVINCIAL DE PASTAZA
(GADPPz) I ETAPA, PARROQUIA FÁTIMA, CANTÓN Y PROVINCIA DE PASTAZA "

PROYECTO:	ANEXO: 1
RUBRO	23
DESCRIPCION	DESALOJO MECANICO VOLQUETA TIERRA/ESCOBROS
UNIDAD	m3
PERIODO	1 DE JUNIO 2021 A 30 DE JUNIO 2021

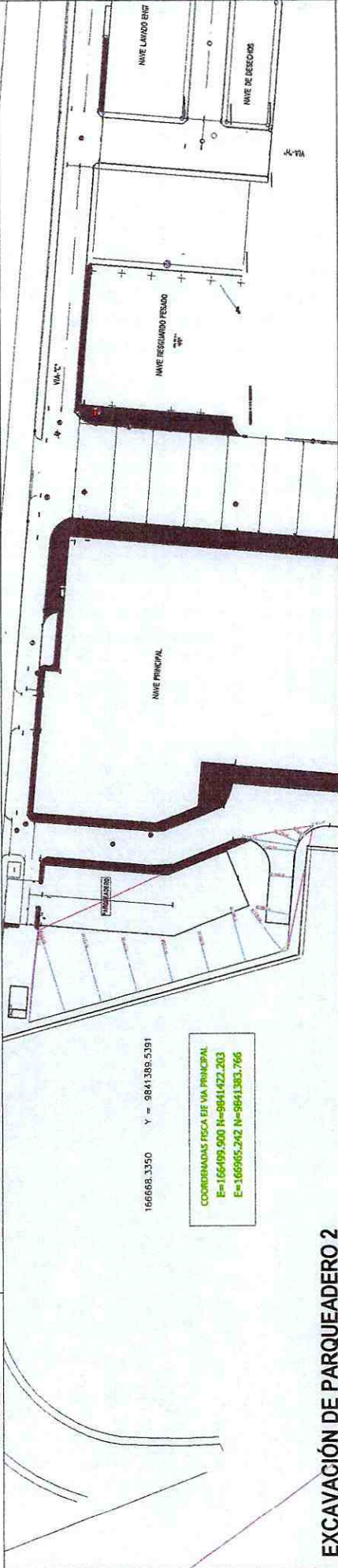

EXCAVACIÓN DE PARQUEADERO 2

Material Table			
Station	Area	Volume	Cumulative Volume
0+000.00	21.05	0.00	0.00
0+010.00	19.45	202.52	202.52
0+020.00	15.48	174.68	377.19
0+030.00	11.72	136.01	513.21
0+040.00	9.34	105.27	618.48
0+050.00	8.86	91.00	709.48
0+060.00	12.26	105.63	815.11
0+070.00	11.58	88.88	903.99
0+080.00	8.12	50.88	954.87
0+090.00	5.08	66.02	1020.88
0+097.18	6.42	41.30	1062.18
0+098.45	11.91	20.31	1082.49
0+099.71	5.60	19.13	1101.63
0+101.61	2.13	10.55	1112.18
0+105.77	0.35	5.60	1117.78

[Handwritten signature]

CONTRATISTA

[Handwritten signature]

FISCALIZACIÓN

" CONSTRUCCIÓN DE LOS HANGARES DEL GOBIERNO AUTÓNOMO DESCENTRALIZADO PROVINCIAL DE PASTAZA
(GADPPz) I ETAPA, PARROQUIA FÁTIMA, CANTÓN Y PROVINCIA DE PASTAZA "



RUBRO	23	ANEXO: 2
DESCRIPCION	DESALOJO MECANICO VOLQUETA TIERRA/ESCOMBROS	
UNIDAD	m3	
PERIODO	1 DE JUNIO 2021 A 30 DE JUNIO 2021	

PERFIL LONGITUDINAL
PARQUEADERO

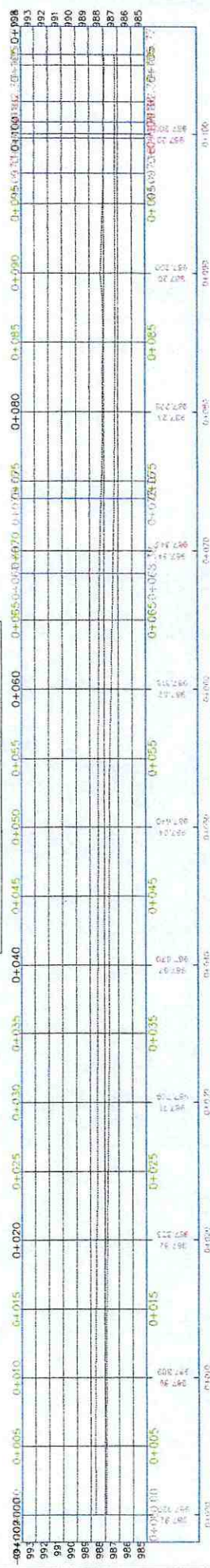

2

CONTRATISTA

LOCALIZACIÓN

" CONSTRUCCIÓN DE LOS HANGARES DEL GOBIERNO AUTÓNOMO DESCENTRALIZADO PROVINCIAL DE PASTAZA
(GADPPP) | ETAPA, PARROQUIA FÁTIMA, CANTÓN Y PROVINCIA DE PASTAZA "

ANEXO: 3

RUBRO 23
DESCRIPCIÓN DESARROLLO MECANICO VOLQUETA TIERRAFESCOMBROS
UNIDAD m3
PERIODO 1 DE JUNIO 2021 A 30 DE JUNIO 2021



SECCIONES DE CORTE	SECCIONES DE CORTE	SECCIONES DE CORTE	SECCIONES DE CORTE																																																																
<p>0+000.00</p> <table border="1"> <thead> <tr> <th colspan="2">ASCISA</th> </tr> </thead> <tbody> <tr> <td>Area en Corte</td> <td>21.05</td> </tr> <tr> <td>Area</td> <td>0.00</td> </tr> <tr> <td>Volumen en Corte</td> <td>0.00</td> </tr> <tr> <td>Volumen en Relleno</td> <td>0.00</td> </tr> <tr> <td>Volumen Acumulado En Corte</td> <td>0.00</td> </tr> <tr> <td>Volumen Acumulado En Relleno</td> <td>0.00</td> </tr> <tr> <td>Volumen Neto</td> <td>0.00</td> </tr> </tbody> </table>	ASCISA		Area en Corte	21.05	Area	0.00	Volumen en Corte	0.00	Volumen en Relleno	0.00	Volumen Acumulado En Corte	0.00	Volumen Acumulado En Relleno	0.00	Volumen Neto	0.00	<p>0+010.00</p> <table border="1"> <thead> <tr> <th colspan="2">ASCISA</th> </tr> </thead> <tbody> <tr> <td>Area en Corte</td> <td>19.45</td> </tr> <tr> <td>Area</td> <td>0.00</td> </tr> <tr> <td>Volumen en Corte</td> <td>202.52</td> </tr> <tr> <td>Volumen en Relleno</td> <td>0.00</td> </tr> <tr> <td>Volumen Acumulado En Corte</td> <td>202.52</td> </tr> <tr> <td>Volumen Acumulado En Relleno</td> <td>0.00</td> </tr> <tr> <td>Volumen Neto</td> <td>202.52</td> </tr> </tbody> </table>	ASCISA		Area en Corte	19.45	Area	0.00	Volumen en Corte	202.52	Volumen en Relleno	0.00	Volumen Acumulado En Corte	202.52	Volumen Acumulado En Relleno	0.00	Volumen Neto	202.52	<p>0+020.00</p> <table border="1"> <thead> <tr> <th colspan="2">ASCISA</th> </tr> </thead> <tbody> <tr> <td>Area en Corte</td> <td>15.48</td> </tr> <tr> <td>Area</td> <td>0.00</td> </tr> <tr> <td>Volumen en Corte</td> <td>174.88</td> </tr> <tr> <td>Volumen en Relleno</td> <td>0.00</td> </tr> <tr> <td>Volumen Acumulado En Corte</td> <td>377.19</td> </tr> <tr> <td>Volumen Acumulado En Relleno</td> <td>0.00</td> </tr> <tr> <td>Volumen Neto</td> <td>377.19</td> </tr> </tbody> </table>	ASCISA		Area en Corte	15.48	Area	0.00	Volumen en Corte	174.88	Volumen en Relleno	0.00	Volumen Acumulado En Corte	377.19	Volumen Acumulado En Relleno	0.00	Volumen Neto	377.19	<p>0+040.00</p> <table border="1"> <thead> <tr> <th colspan="2">ASCISA</th> </tr> </thead> <tbody> <tr> <td>Area en Corte</td> <td>9.34</td> </tr> <tr> <td>Area</td> <td>0.00</td> </tr> <tr> <td>Volumen en Corte</td> <td>105.27</td> </tr> <tr> <td>Volumen en Relleno</td> <td>0.00</td> </tr> <tr> <td>Volumen Acumulado En Corte</td> <td>618.48</td> </tr> <tr> <td>Volumen Acumulado En Relleno</td> <td>0.00</td> </tr> <tr> <td>Volumen Neto</td> <td>618.48</td> </tr> </tbody> </table>	ASCISA		Area en Corte	9.34	Area	0.00	Volumen en Corte	105.27	Volumen en Relleno	0.00	Volumen Acumulado En Corte	618.48	Volumen Acumulado En Relleno	0.00	Volumen Neto	618.48
ASCISA																																																																			
Area en Corte	21.05																																																																		
Area	0.00																																																																		
Volumen en Corte	0.00																																																																		
Volumen en Relleno	0.00																																																																		
Volumen Acumulado En Corte	0.00																																																																		
Volumen Acumulado En Relleno	0.00																																																																		
Volumen Neto	0.00																																																																		
ASCISA																																																																			
Area en Corte	19.45																																																																		
Area	0.00																																																																		
Volumen en Corte	202.52																																																																		
Volumen en Relleno	0.00																																																																		
Volumen Acumulado En Corte	202.52																																																																		
Volumen Acumulado En Relleno	0.00																																																																		
Volumen Neto	202.52																																																																		
ASCISA																																																																			
Area en Corte	15.48																																																																		
Area	0.00																																																																		
Volumen en Corte	174.88																																																																		
Volumen en Relleno	0.00																																																																		
Volumen Acumulado En Corte	377.19																																																																		
Volumen Acumulado En Relleno	0.00																																																																		
Volumen Neto	377.19																																																																		
ASCISA																																																																			
Area en Corte	9.34																																																																		
Area	0.00																																																																		
Volumen en Corte	105.27																																																																		
Volumen en Relleno	0.00																																																																		
Volumen Acumulado En Corte	618.48																																																																		
Volumen Acumulado En Relleno	0.00																																																																		
Volumen Neto	618.48																																																																		
<p>0+030.00</p> <table border="1"> <thead> <tr> <th colspan="2">ASCISA</th> </tr> </thead> <tbody> <tr> <td>Area en Corte</td> <td>8.86</td> </tr> <tr> <td>Area</td> <td>0.00</td> </tr> <tr> <td>Volumen en Corte</td> <td>91.00</td> </tr> <tr> <td>Volumen en Relleno</td> <td>0.00</td> </tr> <tr> <td>Volumen Acumulado En Corte</td> <td>709.48</td> </tr> <tr> <td>Volumen Acumulado En Relleno</td> <td>0.00</td> </tr> <tr> <td>Volumen Neto</td> <td>709.48</td> </tr> </tbody> </table>	ASCISA		Area en Corte	8.86	Area	0.00	Volumen en Corte	91.00	Volumen en Relleno	0.00	Volumen Acumulado En Corte	709.48	Volumen Acumulado En Relleno	0.00	Volumen Neto	709.48	<p>0+050.00</p> <table border="1"> <thead> <tr> <th colspan="2">ASCISA</th> </tr> </thead> <tbody> <tr> <td>Area en Corte</td> <td>12.26</td> </tr> <tr> <td>Area</td> <td>0.00</td> </tr> <tr> <td>Volumen en Corte</td> <td>105.63</td> </tr> <tr> <td>Volumen en Relleno</td> <td>0.00</td> </tr> <tr> <td>Volumen Acumulado En Corte</td> <td>815.11</td> </tr> <tr> <td>Volumen Acumulado En Relleno</td> <td>0.00</td> </tr> <tr> <td>Volumen Neto</td> <td>815.11</td> </tr> </tbody> </table>	ASCISA		Area en Corte	12.26	Area	0.00	Volumen en Corte	105.63	Volumen en Relleno	0.00	Volumen Acumulado En Corte	815.11	Volumen Acumulado En Relleno	0.00	Volumen Neto	815.11	<p>0+060.00</p> <table border="1"> <thead> <tr> <th colspan="2">ASCISA</th> </tr> </thead> <tbody> <tr> <td>Area en Corte</td> <td>8.86</td> </tr> <tr> <td>Area</td> <td>0.00</td> </tr> <tr> <td>Volumen en Corte</td> <td>91.00</td> </tr> <tr> <td>Volumen en Relleno</td> <td>0.00</td> </tr> <tr> <td>Volumen Acumulado En Corte</td> <td>709.48</td> </tr> <tr> <td>Volumen Acumulado En Relleno</td> <td>0.00</td> </tr> <tr> <td>Volumen Neto</td> <td>709.48</td> </tr> </tbody> </table>	ASCISA		Area en Corte	8.86	Area	0.00	Volumen en Corte	91.00	Volumen en Relleno	0.00	Volumen Acumulado En Corte	709.48	Volumen Acumulado En Relleno	0.00	Volumen Neto	709.48	<p>0+070.00</p> <table border="1"> <thead> <tr> <th colspan="2">ASCISA</th> </tr> </thead> <tbody> <tr> <td>Area en Corte</td> <td>12.26</td> </tr> <tr> <td>Area</td> <td>0.00</td> </tr> <tr> <td>Volumen en Corte</td> <td>105.63</td> </tr> <tr> <td>Volumen en Relleno</td> <td>0.00</td> </tr> <tr> <td>Volumen Acumulado En Corte</td> <td>815.11</td> </tr> <tr> <td>Volumen Acumulado En Relleno</td> <td>0.00</td> </tr> <tr> <td>Volumen Neto</td> <td>815.11</td> </tr> </tbody> </table>	ASCISA		Area en Corte	12.26	Area	0.00	Volumen en Corte	105.63	Volumen en Relleno	0.00	Volumen Acumulado En Corte	815.11	Volumen Acumulado En Relleno	0.00	Volumen Neto	815.11
ASCISA																																																																			
Area en Corte	8.86																																																																		
Area	0.00																																																																		
Volumen en Corte	91.00																																																																		
Volumen en Relleno	0.00																																																																		
Volumen Acumulado En Corte	709.48																																																																		
Volumen Acumulado En Relleno	0.00																																																																		
Volumen Neto	709.48																																																																		
ASCISA																																																																			
Area en Corte	12.26																																																																		
Area	0.00																																																																		
Volumen en Corte	105.63																																																																		
Volumen en Relleno	0.00																																																																		
Volumen Acumulado En Corte	815.11																																																																		
Volumen Acumulado En Relleno	0.00																																																																		
Volumen Neto	815.11																																																																		
ASCISA																																																																			
Area en Corte	8.86																																																																		
Area	0.00																																																																		
Volumen en Corte	91.00																																																																		
Volumen en Relleno	0.00																																																																		
Volumen Acumulado En Corte	709.48																																																																		
Volumen Acumulado En Relleno	0.00																																																																		
Volumen Neto	709.48																																																																		
ASCISA																																																																			
Area en Corte	12.26																																																																		
Area	0.00																																																																		
Volumen en Corte	105.63																																																																		
Volumen en Relleno	0.00																																																																		
Volumen Acumulado En Corte	815.11																																																																		
Volumen Acumulado En Relleno	0.00																																																																		
Volumen Neto	815.11																																																																		

[Signature]

CONTRATISTA

[Signature]

FISCALIZACIÓN

" CONSTRUCCIÓN DE LOS HANGARES DEL GOBIERNO AUTÓNOMO DESCENTRALIZADO PROVINCIAL DE PASTAZA
(GADPPz) | ETAPA, PARROQUIA FÁTIMA, CANTÓN Y PROVINCIA DE PASTAZA "



ANEXO: 4

RUBRO	23
DESCRIPCION	DESALOJO MECANICO VOLQUETA TIERRAESCOMBROS
UNIDAD	m3
PERIODO	1 DE JUNIO 2021 A 30 DE JUNIO 2021

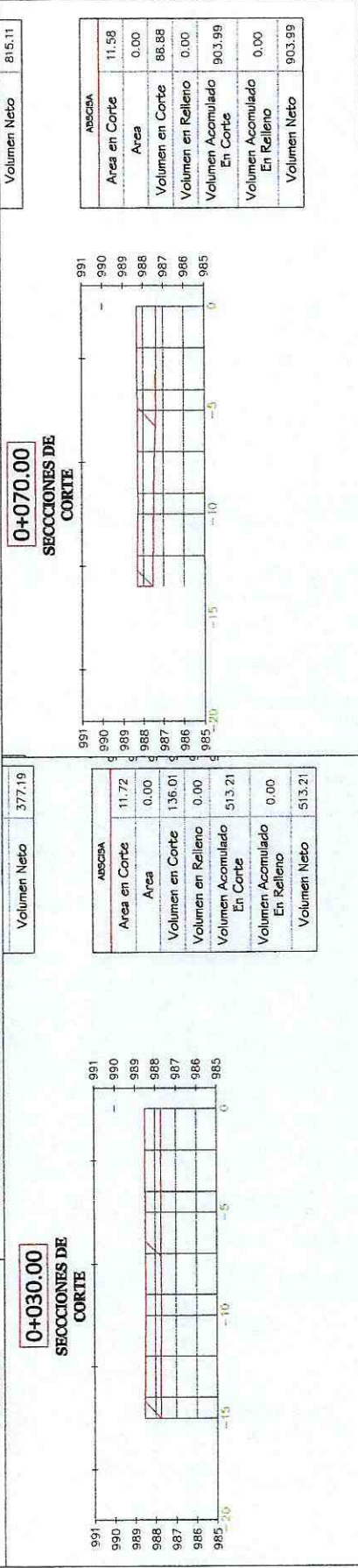

CONTRATISTA

FISCALIZACIÓN

**GOBIERNO AUTÓNOMO DESCENTRALIZADO DE LA
PROVINCIA DEL PASTAZA**

" CONSTRUCCIÓN DE LOS HANGARES DEL GOBIERNO AUTÓNOMO DESCENTRALIZADO PROVINCIAL DE PASTAZA
(GADPPZ) | ETAPA, PARROQUIA FÁTIMA, CANTÓN Y PROVINCIA DE PASTAZA "



ANEXO: 5

RUBRO 23
DESCRIPCION DESALOJO MECANICO VOLQUETA TIERRAESCOMBROS
UNIDAD m3
PERIODO 1 DE JUNIO 2021 A 30 DE JUNIO 2021

0+080.00
SECCIONES DE CORTE

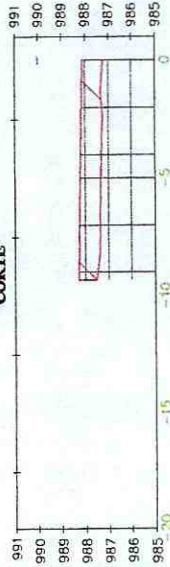

ABSCISA	
Area en Corte	8.12
Area	0.00
Volumen en Corte	50.88
Volumen en Relleno	0.00
Volumen Acomulado En Corte	954.87
Volumen Acomulado En Relleno	0.00
Volumen Neto	954.87

0+090.00
SECCIONES DE CORTE

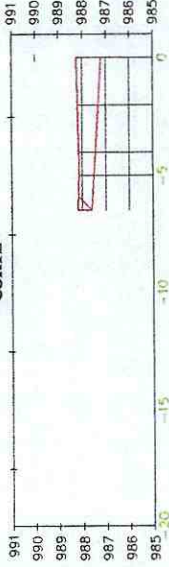

ABSCISA	
Area en Corte	5.08
Area	0.00
Volumen en Corte	66.02
Volumen en Relleno	0.00
Volumen Acomulado En Corte	1020.88
Volumen Acomulado En Relleno	0.00
Volumen Neto	1020.88

0+097.18
SECCIONES DE CORTE

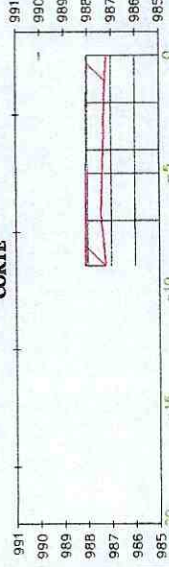

ABSCISA	
Area en Corte	6.42
Area	0.00
Volumen en Corte	41.30
Volumen en Relleno	0.00
Volumen Acomulado En Corte	1062.18
Volumen Acomulado En Relleno	0.00
Volumen Neto	1062.18

0+098.45
SECCIONES DE CORTE



0+099.71
SECCIONES DE CORTE

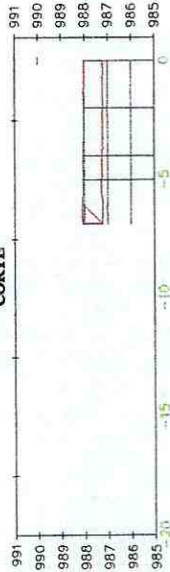

ABSCISA	
Area en Corte	5.60
Area	0.00
Volumen en Corte	19.13
Volumen en Relleno	0.00
Volumen Acomulado En Corte	1101.63
Volumen Acomulado En Relleno	0.00
Volumen Neto	1101.63

0+101.61
SECCIONES DE CORTE

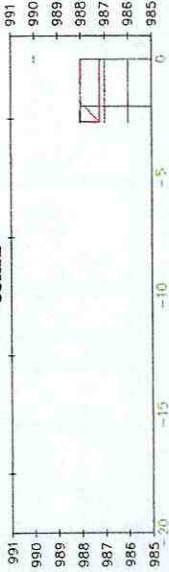

ABSCISA	
Area en Corte	2.13
Area	0.00
Volumen en Corte	10.55
Volumen en Relleno	0.00
Volumen Acomulado En Corte	1112.18
Volumen Acomulado En Relleno	0.00
Volumen Neto	1112.18

0+105.77
SECCIONES DE CORTE

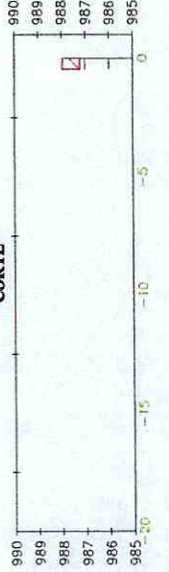

ABSCISA	
Area en Corte	0.35
Area	0.00
Volumen en Corte	5.60
Volumen en Relleno	0.00
Volumen Acomulado En Corte	1117.78
Volumen Acomulado En Relleno	0.00
Volumen Neto	1117.78

[Signature]
CONTRATISTA

[Signature]
FISCALIZACIÓN

**GOBIERNO AUTÓNOMO DESCENTRALIZADO DE LA
PROVINCIA DEL PASTAZA**

" CONSTRUCCIÓN DE LOS HANGARES DEL GOBIERNO AUTÓNOMO DESCENTRALIZADO PROVINCIAL DE PASTAZA
(GADPPZ) | ETAPA, PARROQUIA FÁTIMA, CANTÓN Y PROVINCIA DE PASTAZA "



ANEXO: 6

RUBRO	23
DESCRIPCION	DESALOJO MECANICO VOLQUETA TIERRA/ESCOMBROS
UNIDAD	m3
PERIODO	1 DE JUNIO 2021 A 30 DE JUNIO 2021

0+098.45

SECCIONES DE
CORTE

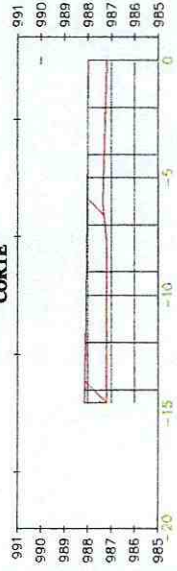

Volumen Neto	1082.18
--------------	---------

ASCISA	
Area en Corte	11.91
Area	0.00
Volumen en Corte	20.31
Volumen en Relleno	0.00
Volumen Acomulado En Corte	1082.49
Volumen Acomulado En Relleno	0.00
Volumen Neto	1082.49

CONTRATISTA

FISCALIZACION

* CONSTRUCCIÓN DE LOS HANGARES DEL GOBIERNO AUTÓNOMO DESCENTRALIZADO PROVINCIAL DE PASTAZA (GADPPz) I ETAPA, PARROQUJA FÁTIMA, CANTÓN Y PROVINCIA DE PASTAZA *



ANEXO: 7

RUBRO	23
DESCRIPCION	DESALOJO MECANICO VOLQUETA TIERRA/ESCOMBROS
UNIDAD	m3
PERIODO	1 DE JUNIO 2021 A 30 DE JUNIO 2021

PROYECTO:

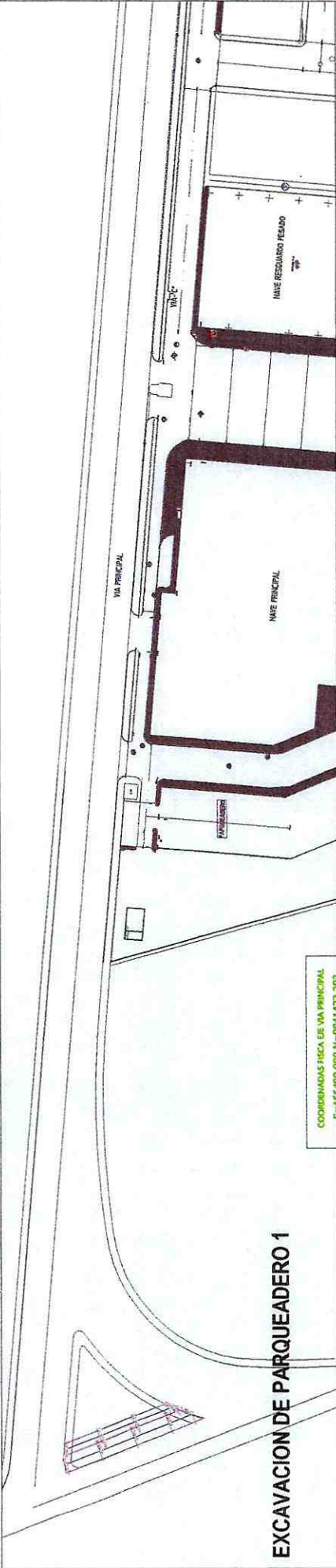

EXCAVACION DE PARQUEADERO 1

COORDENADAS FISICA DE VIA PRINCIPAL
E=156499.000 N=9641422.200

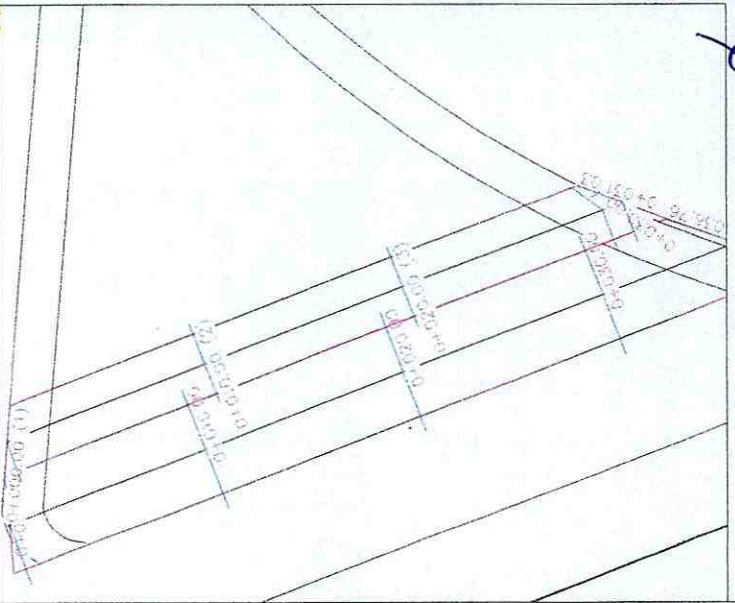

Total Volume Table

Station	Fill Area	Cut Area	Fill Volume	Cut Volume	Cumulative Fill Vol	Cumulative Cut Vol
0+000.12	0.00	8.33	0.00	0.00	0.00	0.00
0+010.00	0.00	8.19	0.00	81.62	0.00	81.62
0+020.00	0.00	8.19	0.00	81.89	0.00	163.51
0+030.00	0.00	5.19	0.00	81.89	0.00	245.40
0+036.76	0.00	10.47	0.00	63.03	0.00	308.44

Total Volume Table

Station	Fill Area	Cut Area	Fill Volume	Cut Volume	Cumulative Fill Vol	Cumulative Cut Vol
0+000.01	0.00	2.60	0.00	0.00	0.00	0.00
0+010.00	0.00	2.46	0.00	25.30	0.00	25.30
0+020.00	0.00	2.46	0.00	24.60	0.00	49.90
0+030.00	0.00	2.67	0.00	25.65	0.00	75.55
0+031.03	0.00	3.08	0.00	2.96	0.00	78.50

CONTRATISTA

FISCALIZACIÓN

" CONSTRUCCIÓN DE LOS HANGARES DEL GOBIERNO AUTÓNOMO DESCENTRALIZADO PROVINCIAL DE PASTAZA
(GADPPP) I ETAPA, PARROQUIA FÁTIMA, CANTÓN Y PROVINCIA DE PASTAZA "



ANEXO: 8

RUBRO	23
DESCRIPCION	DESALOJO MECANICO VOLQUETA TIERRA/ESCOBROS
UNIDAD	m3
PERIODO	1 DE JUNIO 2021 A 30 DE JUNIO 2021

PROYECTO:

**PERFIL LONGITUDINAL
PARADA DE BUSS**

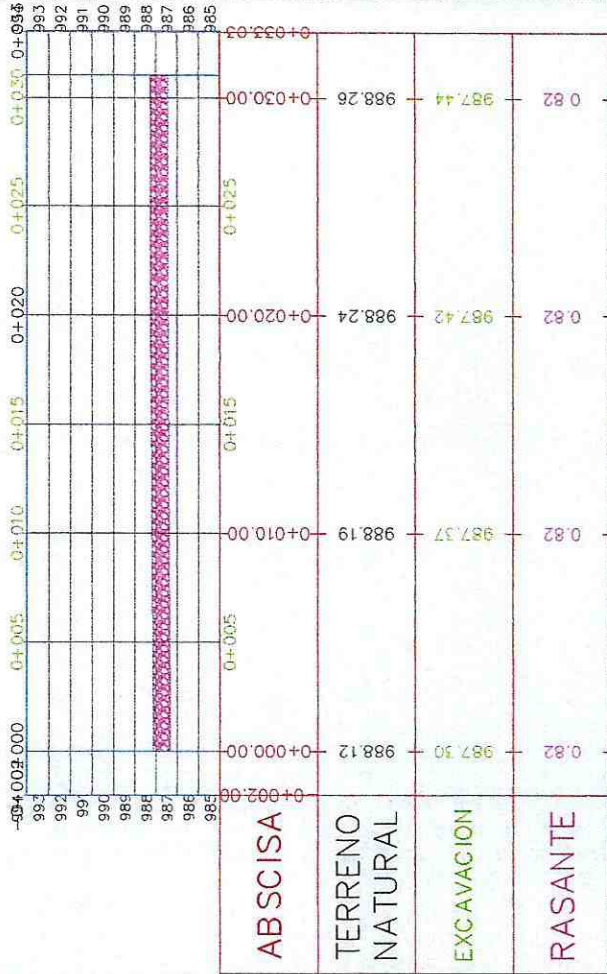

**PERFIL LONGITUDINAL
PARADA DE BUSS**

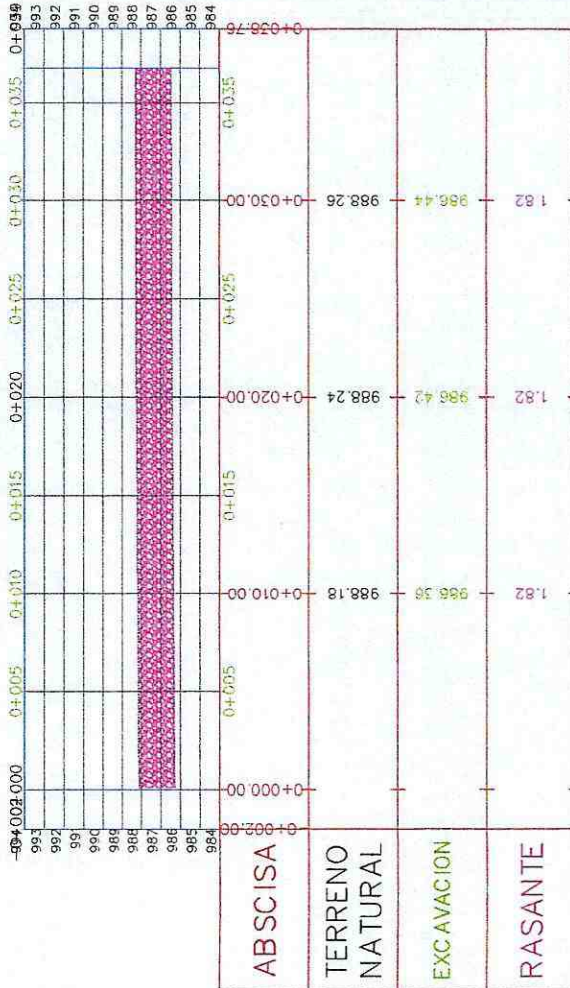

[Signature]

CONTRATISTA

[Signature]

FISCALIZACIÓN

" CONSTRUCCIÓN DE LOS HANGARES DEL GOBIERNO AUTÓNOMO DESCENTRALIZADO PROVINCIAL DE PASTAZA
(GADPPZ) | ETAPA, PARROQUIA FÁTIMA, CANTÓN Y PROVINCIA DE PASTAZA "



ANEXO: 9

PROYECTO:

RUBRO	23
DESCRIPCION	DESAROLLO MECANICO VOLQUETA TIERRAESCOMBROS
UNIDAD	m3
PERIODO	1 DE JUNIO 2021 A 30 DE JUNIO 2021

0+000.12

SECCIONES DE CORTE

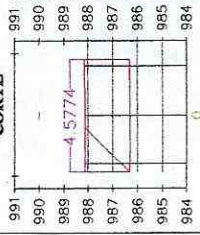

ABSCISA	
Area en Corte	8.33
Area	0.00
Volumen en Corte	0.00
Volumen en Relleno	0.00
Volumen Acumulado En Corte	0.00
Volumen Acumulado En Relleno	0.00
Volumen Neto	0.00

0+030.00

SECCIONES DE CORTE

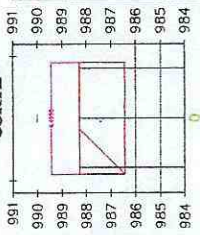

ABSCISA	
Area en Corte	8.19
Area	0.00
Volumen en Corte	81.89
Volumen en Relleno	0.00
Volumen Acumulado En Corte	245.40
Volumen Acumulado En Relleno	0.00
Volumen Neto	245.40

0+010.00

SECCIONES DE CORTE

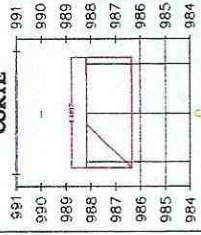

ABSCISA	
Area en Corte	8.19
Area	0.00
Volumen en Corte	81.62
Volumen en Relleno	0.00
Volumen Acumulado En Corte	81.62
Volumen Acumulado En Relleno	0.00
Volumen Neto	81.62

0+036.76

SECCIONES DE CORTE

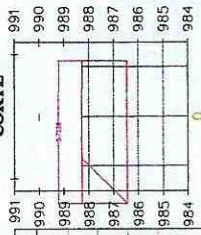

ABSCISA	
Area en Corte	10.47
Area	0.00
Volumen en Corte	63.03
Volumen en Relleno	0.00
Volumen Acumulado En Corte	308.44
Volumen Acumulado En Relleno	0.00
Volumen Neto	308.44

0+020.00

SECCIONES DE CORTE

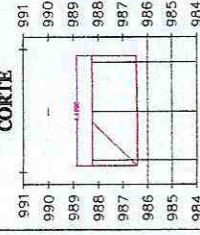

ABSCISA	
Area en Corte	8.19
Area	0.00
Volumen en Corte	81.89
Volumen en Relleno	0.00
Volumen Acumulado En Corte	163.51
Volumen Acumulado En Relleno	0.00
Volumen Neto	163.51

0+000.12

SECCIONES DE CORTE

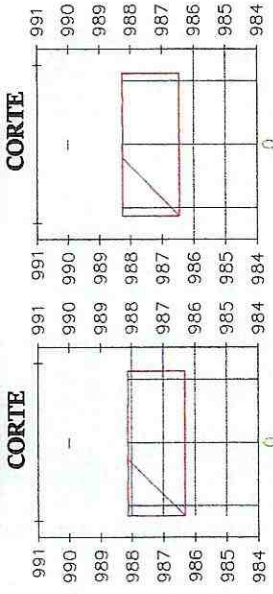

0+030.00

SECCIONES DE CORTE

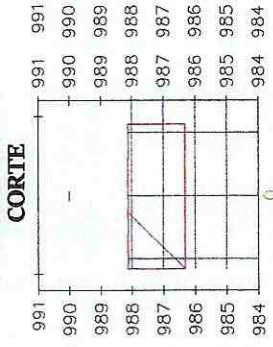

0+010.00

SECCIONES DE CORTE

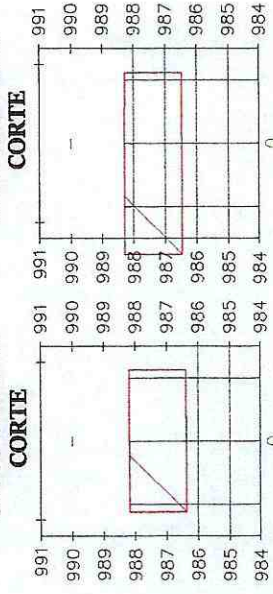

0+036.76

SECCIONES DE CORTE

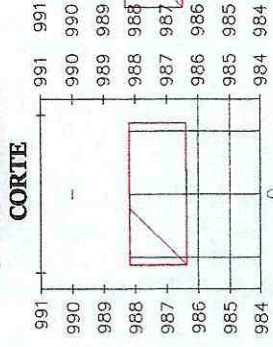

0+020.00

SECCIONES DE CORTE

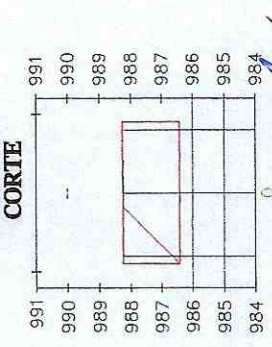

CONTRATISTA

FISCALIZACIÓN

" CONSTRUCCIÓN DE LOS HANGARES DEL GOBIERNO AUTÓNOMO DESCENTRALIZADO PROVINCIAL DE PASTAZA
(GADPPz) I ETAPA, PARROQUIA FÁTIMA, CANTÓN Y PROVINCIA DE PASTAZA "



ANEXO: 10

RUBRO 23
DESCRIPCIÓN DESALOJO MECANICO VOLQUETA TIERRA/ESCOBROS
UNIDAD m3
PERIODO 1 DE JUNIO 2021 A 30 DE JUNIO 2021

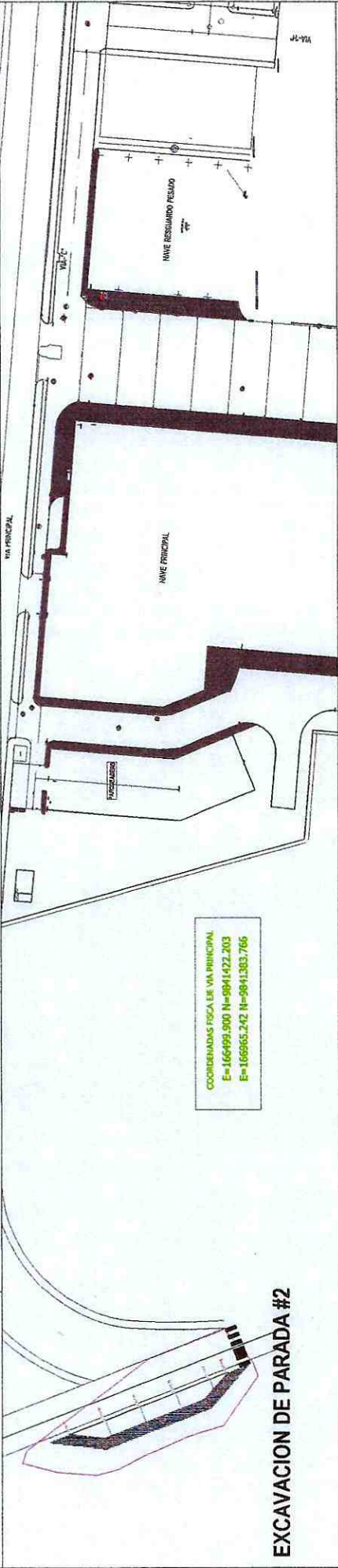

EXCAVACION DE PARADA #2

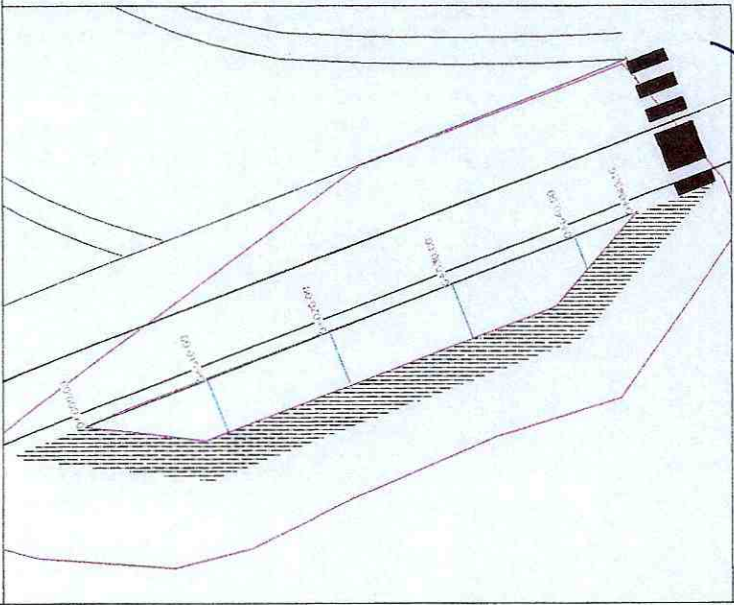

**TABLA DE VOLUMENES
EXCAVACION VIA**

Station	Area	Volume	Cumulative Volume
0+000.21	0.11	0.00	0.00
0+010.00	5.15	25.74	25.74
0+020.00	6.71	59.29	85.03
0+030.00	7.08	68.94	153.97
0+040.00	3.17	51.26	205.22
0+045.05	0.06	8.16	213.39

CONTRATISTA

FECCAZACION

" CONSTRUCCIÓN DE LOS HANGARES DEL GOBIERNO AUTÓNOMO DESCENTRALIZADO PROVINCIAL DE PASTAZA
(GADPPZ) I ETAPA, PARROQUIA FÁTIMA, CANTÓN Y PROVINCIA DE PASTAZA "



ANEXO: 11

RUBRO 23
DESCRIPCION DESALJO MECANICO VOLQUETA TIERRA/ESCOMBROS
UNIDAD m3
PERIODO 1 DE JUNIO 2021 A 30 DE JUNIO 2021

PROYECTO:

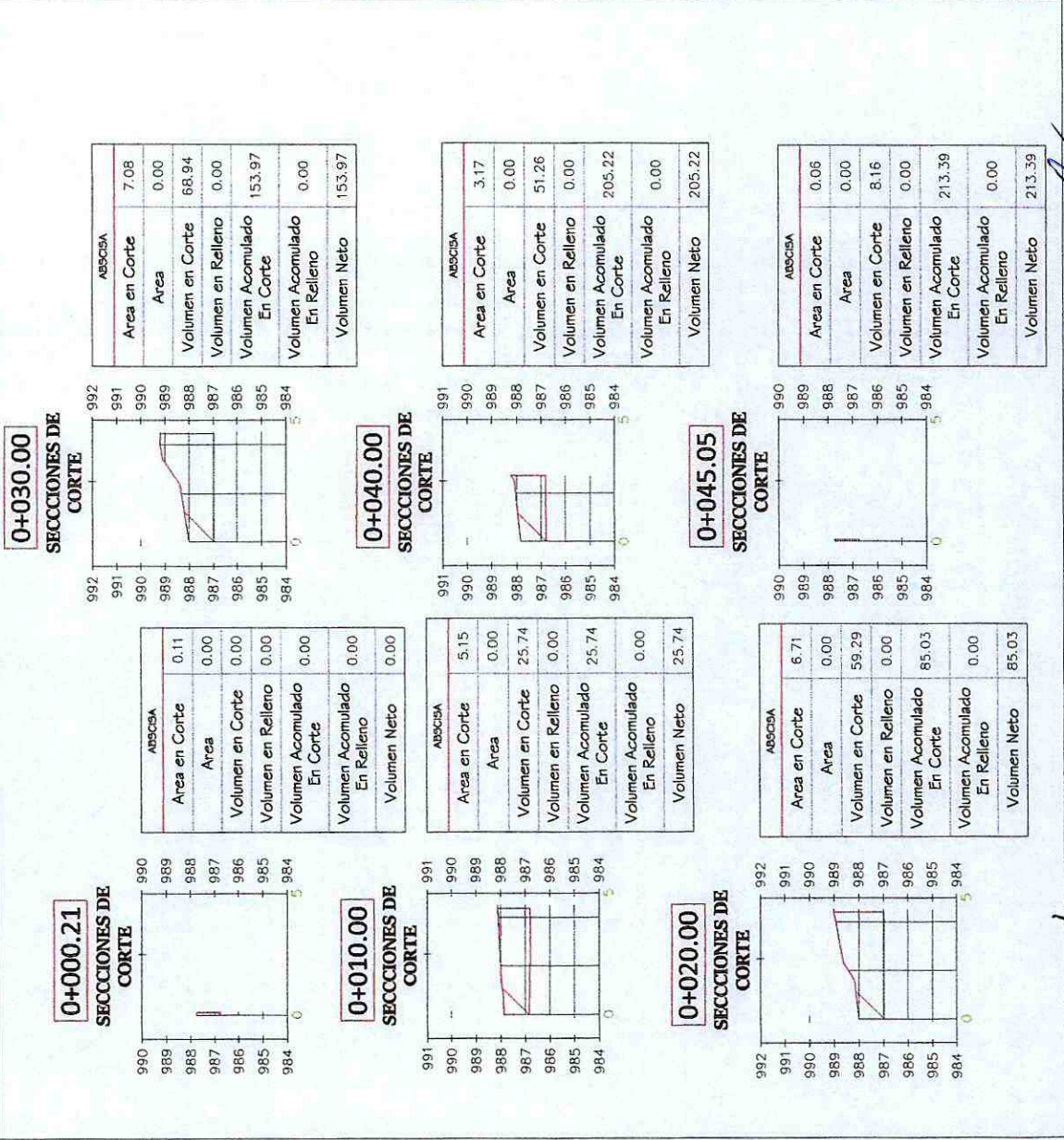

[Signature]

CONTRATISTA

[Signature]

FISCALIZACION

**GOBIERNO AUTÓNOMO DESCENTRALIZADO DE
PROVINCIA DEL PASTAZA**

" CONSTRUCCIÓN DE LOS HANGARES DEL GOBIERNO AUTÓNOMO DESCENTRALIZADO PROVINCIAL DE PASTAZA
(GADPPZ) I ETAPA, PARROQUIA FÁTIMA, CANTÓN Y PROVINCIA DE PASTAZA "

ANEXO: 12

23
RUBRO
DESCRIPCIÓN
UNIDAD
PERIODO
DESARROLLO MECANICO VOLQUETA TIERRA ESCOMBROS
m³
1 DE JUNIO 2021 A 30 DE JUNIO 2021

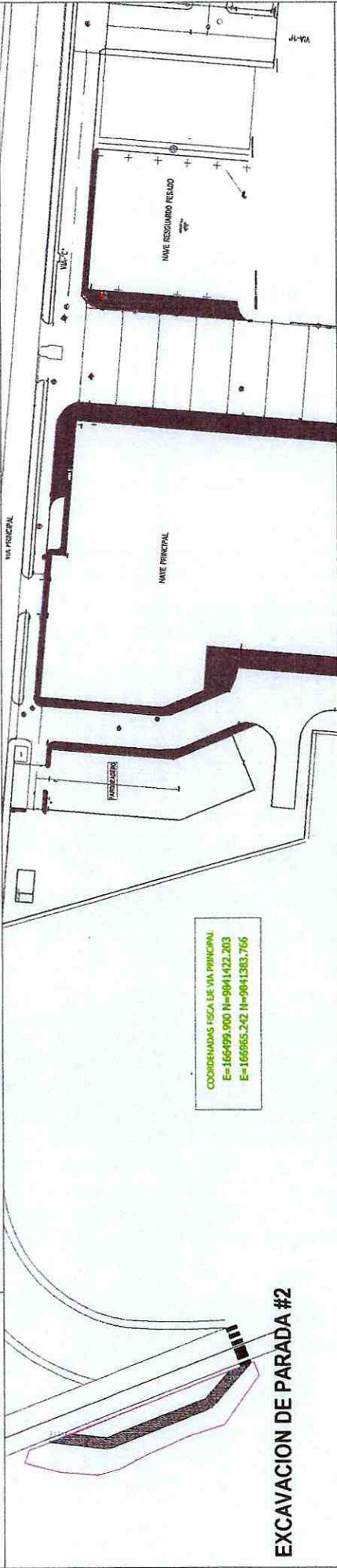

EXCAVACION DE PARADA #2



TABLA DE VOLUMENES EXCAVACION ACERA

Station	Area	Volume	Cumulative Volume
0+000.00	0.03	0.00	0.00
0+001.00	0.20	0.10	0.10
0+002.00	0.39	0.30	0.40
0+003.00	0.56	0.49	0.88
0+004.00	0.76	0.67	1.55
0+005.00	0.95	0.86	2.41
0+006.00	1.16	1.07	3.48
0+007.00	1.16	1.17	4.65
0+008.00	1.11	1.13	5.78
0+009.00	1.04	1.08	6.86
0+010.00	0.95	1.00	7.86
0+011.00	1.10	1.03	8.89
0+012.00	1.30	1.20	10.09
0+013.00	1.51	1.41	11.50
0+014.00	1.66	1.58	13.09
0+015.00	1.68	1.67	14.76
0+015.16	1.68	0.27	15.02
0+015.84	1.70	0.44	15.46
0+016.00	1.71	0.11	15.57
0+016.92	1.75	0.35	15.92

TABLA DE VOLUMENES EXCAVACION ACERA

Station	Area	Volume	Cumulative Volume
0+017.00	1.82	0.86	16.78
0+018.00	1.93	1.88	18.65
0+019.00	1.98	1.95	20.61
0+020.00	1.96	1.97	22.57
0+021.00	1.87	1.91	24.49
0+022.00	1.82	1.85	26.33
0+023.00	2.21	2.02	28.35
0+024.00	2.72	2.47	30.82
0+025.00	3.09	2.91	33.72
0+026.00	3.16	3.12	36.85
0+027.00	3.30	3.23	40.07
0+028.00	3.54	3.42	43.49
0+029.00	3.75	3.64	47.13
0+030.00	3.89	3.82	50.95
0+031.00	3.96	3.95	54.88
0+032.00	3.98	3.97	58.85
0+033.00	3.95	3.96	62.82
0+034.00	3.86	3.90	66.72
0+035.00	3.82	3.84	70.56
0+036.00	4.11	3.97	74.53

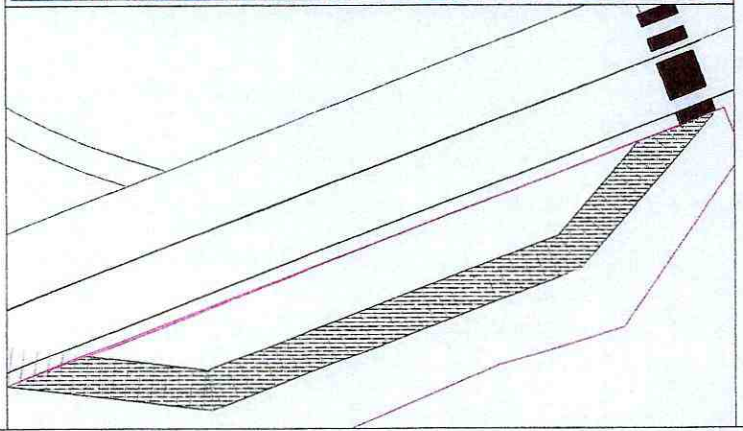
TABLA DE VOLUMENES EXCAVACION ACERA

Station	Area	Volume	Cumulative Volume
0+037.00	4.63	4.37	78.90
0+038.00	4.71	4.67	83.57
0+039.00	4.59	4.65	88.23
0+040.00	4.47	4.53	92.76
0+041.00	4.31	4.39	97.14
0+042.00	4.12	4.22	101.36
0+043.00	3.89	4.01	105.37
0+044.00	3.63	3.76	109.13
0+044.29	3.54	1.05	110.18
0+045.00	3.39	1.88	112.06
0+045.79	3.16	2.00	114.06
0+046.00	3.11	0.50	114.55
0+047.00	2.61	2.28	116.83
0+047.30	2.90	0.65	117.48
0+048.00	3.29	2.18	119.66
0+049.00	3.82	3.55	123.21
0+050.00	4.10	3.96	127.17
0+051.00	3.59	3.84	131.01
0+052.00	3.48	3.53	134.54
0+053.00	3.27	3.37	137.91

TABLA DE VOLUMENES EXCAVACION ACERA

Station	Area	Volume	Cumulative Volume
0+054.00	3.07	3.17	141.08
0+055.00	2.86	2.96	144.05
0+056.00	2.57	2.71	146.76
0+057.00	1.97	2.27	149.03
0+058.00	1.32	1.64	150.67
0+059.00	0.73	1.02	151.70
0+060.00	0.40	0.57	152.26
0+061.00	0.11	0.26	152.52
0+061.40	0.01	0.03	152.54

CONTRATISTA

FECALIZACION

GOBIERNO AUTONOMO DESCENTRALIZADO DE PASTAZA
PROVINCIA DEL PASTAZA

" CONSTRUCCIÓN DE LOS HANGARES DEL GOBIERNO AUTÓNOMO DESCENTRALIZADO PROVINCIAL DE PASTAZA (GADPPZ) | ETAPA, PARROQUIA FÁTIMA, CANTÓN Y PROVINCIA DE PASTAZA "

ANEXO: 13

23
 DESALOJO MECANICO VOLQUETA TIERRAESCOMBROS
 m3
 1 DE JUNIO 2021 A 30 DE JUNIO 2021



PROYECTO:

RUBRO	23
DESCRIPCION	DESALOJO MECANICO VOLQUETA TIERRAESCOMBROS
UNIDAD	m3
PERIODO	1 DE JUNIO 2021 A 30 DE JUNIO 2021

SECCIONES DE CORTE	ABSCISA	Area en Corte	Area	Volumen en Corte	Volumen en Relleno	Volumen Acomulado En Corte	Volumen Acomulado En Relleno	Volumen Neto
0+000.00	990	0.00	0.00	0.00	0.00	0.00	0.00	0.00
	989	0.00	0.00	0.00	0.00	0.00	0.00	0.00
	988	0.00	0.00	0.00	0.00	0.00	0.00	0.00
	987	0.00	0.00	0.00	0.00	0.00	0.00	0.00
	986	0.00	0.00	0.00	0.00	0.00	0.00	0.00
	985	0.00	0.00	0.00	0.00	0.00	0.00	0.00
0+001.00	990	0.20	0.00	0.10	0.00	0.10	0.00	0.10
	989	0.00	0.00	0.00	0.00	0.00	0.00	0.00
	988	0.00	0.00	0.00	0.00	0.00	0.00	0.00
	987	0.10	0.00	0.10	0.00	0.10	0.00	0.10
	986	0.00	0.00	0.00	0.00	0.00	0.00	0.00
	985	0.00	0.00	0.00	0.00	0.00	0.00	0.00
0+002.00	990	0.39	0.00	0.30	0.00	0.30	0.00	0.40
	989	0.00	0.00	0.00	0.00	0.00	0.00	0.00
	988	0.00	0.00	0.00	0.00	0.00	0.00	0.00
	987	0.40	0.00	0.40	0.00	0.40	0.00	0.40
	986	0.00	0.00	0.00	0.00	0.00	0.00	0.00
	985	0.00	0.00	0.00	0.00	0.00	0.00	0.00
0+009.00	990	1.04	0.00	1.08	0.00	6.86	0.00	6.86
	989	0.00	0.00	0.00	0.00	0.00	0.00	0.00
	988	0.00	0.00	0.00	0.00	0.00	0.00	0.00
	987	0.00	0.00	0.00	0.00	0.00	0.00	0.00
	986	0.00	0.00	0.00	0.00	0.00	0.00	0.00
	985	0.00	0.00	0.00	0.00	0.00	0.00	0.00
0+010.00	990	0.96	0.00	1.00	0.00	7.86	0.00	7.86
	989	0.00	0.00	0.00	0.00	0.00	0.00	0.00
	988	0.00	0.00	0.00	0.00	0.00	0.00	0.00
	987	0.00	0.00	0.00	0.00	0.00	0.00	0.00
	986	0.00	0.00	0.00	0.00	0.00	0.00	0.00
	985	0.00	0.00	0.00	0.00	0.00	0.00	0.00
0+016.00	991	1.71	0.00	0.11	0.00	15.57	0.00	15.57
	990	0.00	0.00	0.00	0.00	0.00	0.00	0.00
	989	0.00	0.00	0.00	0.00	0.00	0.00	0.00
	988	0.00	0.00	0.00	0.00	0.00	0.00	0.00
	987	0.00	0.00	0.00	0.00	0.00	0.00	0.00
	986	0.00	0.00	0.00	0.00	0.00	0.00	0.00
	985	0.00	0.00	0.00	0.00	0.00	0.00	0.00
0+016.52	991	1.75	0.00	0.35	0.00	15.92	0.00	15.92
	990	0.00	0.00	0.00	0.00	0.00	0.00	0.00
	989	0.00	0.00	0.00	0.00	0.00	0.00	0.00
	988	0.00	0.00	0.00	0.00	0.00	0.00	0.00
	987	0.00	0.00	0.00	0.00	0.00	0.00	0.00
	986	0.00	0.00	0.00	0.00	0.00	0.00	0.00
	985	0.00	0.00	0.00	0.00	0.00	0.00	0.00
0+017.00	991	1.82	0.00	0.86	0.00	16.78	0.00	16.78
	990	0.00	0.00	0.00	0.00	0.00	0.00	0.00
	989	0.00	0.00	0.00	0.00	0.00	0.00	0.00
	988	0.00	0.00	0.00	0.00	0.00	0.00	0.00
	987	0.00	0.00	0.00	0.00	0.00	0.00	0.00
	986	0.00	0.00	0.00	0.00	0.00	0.00	0.00
	985	0.00	0.00	0.00	0.00	0.00	0.00	0.00

FISCALIZACIÓN

CONTRATISTA

" CONSTRUCCIÓN DE LOS HANGARES DEL GOBIERNO AUTÓNOMO DESCENTRALIZADO PROVINCIAL DE PASTAZA
(GADPPZ) | ETAPA, PARROQUIA FÁTIMA, CANTÓN Y PROVINCIA DE PASTAZA "

ANEJO: 14

RUBRO 23
DESCRIPCIÓN DESARROLLO MECÁNICO VOLQUETA TIERRA/ESCOBROS
UNIDAD m³
PERIODO 1 DE JUNIO 2021 A 30 DE JUNIO 2021



SECCIONES DE CORTE	SECCIONES DE CORTE	SECCIONES DE CORTE	SECCIONES DE CORTE	SECCIONES DE CORTE	SECCIONES DE CORTE	SECCIONES DE CORTE	SECCIONES DE CORTE	SECCIONES DE CORTE	SECCIONES DE CORTE																																																																																																																																																																																	
<p>0+003.00</p> <table border="1"> <tr><th colspan="2">ABSCISA</th></tr> <tr><td>Area en Corte</td><td>0.58</td></tr> <tr><td>Area</td><td>0.00</td></tr> <tr><td>Volumen en Corte</td><td>0.49</td></tr> <tr><td>Volumen en Relleno</td><td>0.00</td></tr> <tr><td>Volumen Acomulado En Corte</td><td>0.88</td></tr> <tr><td>Volumen Acomulado En Relleno</td><td>0.00</td></tr> <tr><td>Volumen Neto</td><td>0.88</td></tr> </table>	ABSCISA		Area en Corte	0.58	Area	0.00	Volumen en Corte	0.49	Volumen en Relleno	0.00	Volumen Acomulado En Corte	0.88	Volumen Acomulado En Relleno	0.00	Volumen Neto	0.88	<p>0+004.00</p> <table border="1"> <tr><th colspan="2">ABSCISA</th></tr> <tr><td>Area en Corte</td><td>0.76</td></tr> <tr><td>Area</td><td>0.00</td></tr> <tr><td>Volumen en Corte</td><td>0.67</td></tr> <tr><td>Volumen en Relleno</td><td>0.00</td></tr> <tr><td>Volumen Acomulado En Corte</td><td>1.55</td></tr> <tr><td>Volumen Acomulado En Relleno</td><td>0.00</td></tr> <tr><td>Volumen Neto</td><td>1.55</td></tr> </table>	ABSCISA		Area en Corte	0.76	Area	0.00	Volumen en Corte	0.67	Volumen en Relleno	0.00	Volumen Acomulado En Corte	1.55	Volumen Acomulado En Relleno	0.00	Volumen Neto	1.55	<p>0+005.00</p> <table border="1"> <tr><th colspan="2">ABSCISA</th></tr> <tr><td>Area en Corte</td><td>0.96</td></tr> <tr><td>Area</td><td>0.00</td></tr> <tr><td>Volumen en Corte</td><td>0.86</td></tr> <tr><td>Volumen en Relleno</td><td>0.00</td></tr> <tr><td>Volumen Acomulado En Corte</td><td>2.41</td></tr> <tr><td>Volumen Acomulado En Relleno</td><td>0.00</td></tr> <tr><td>Volumen Neto</td><td>2.41</td></tr> </table>	ABSCISA		Area en Corte	0.96	Area	0.00	Volumen en Corte	0.86	Volumen en Relleno	0.00	Volumen Acomulado En Corte	2.41	Volumen Acomulado En Relleno	0.00	Volumen Neto	2.41	<p>0+012.00</p> <table border="1"> <tr><th colspan="2">ABSCISA</th></tr> <tr><td>Area en Corte</td><td>1.30</td></tr> <tr><td>Area</td><td>0.00</td></tr> <tr><td>Volumen en Corte</td><td>1.20</td></tr> <tr><td>Volumen en Relleno</td><td>0.00</td></tr> <tr><td>Volumen Acomulado En Corte</td><td>10.09</td></tr> <tr><td>Volumen Acomulado En Relleno</td><td>0.00</td></tr> <tr><td>Volumen Neto</td><td>10.09</td></tr> </table>	ABSCISA		Area en Corte	1.30	Area	0.00	Volumen en Corte	1.20	Volumen en Relleno	0.00	Volumen Acomulado En Corte	10.09	Volumen Acomulado En Relleno	0.00	Volumen Neto	10.09	<p>0+013.00</p> <table border="1"> <tr><th colspan="2">ABSCISA</th></tr> <tr><td>Area en Corte</td><td>1.51</td></tr> <tr><td>Area</td><td>0.00</td></tr> <tr><td>Volumen en Corte</td><td>1.41</td></tr> <tr><td>Volumen en Relleno</td><td>0.00</td></tr> <tr><td>Volumen Acomulado En Corte</td><td>11.50</td></tr> <tr><td>Volumen Acomulado En Relleno</td><td>0.00</td></tr> <tr><td>Volumen Neto</td><td>11.50</td></tr> </table>	ABSCISA		Area en Corte	1.51	Area	0.00	Volumen en Corte	1.41	Volumen en Relleno	0.00	Volumen Acomulado En Corte	11.50	Volumen Acomulado En Relleno	0.00	Volumen Neto	11.50	<p>0+018.00</p> <table border="1"> <tr><th colspan="2">ABSCISA</th></tr> <tr><td>Area en Corte</td><td>1.93</td></tr> <tr><td>Area</td><td>0.00</td></tr> <tr><td>Volumen en Corte</td><td>1.88</td></tr> <tr><td>Volumen en Relleno</td><td>0.00</td></tr> <tr><td>Volumen Acomulado En Corte</td><td>18.65</td></tr> <tr><td>Volumen Acomulado En Relleno</td><td>0.00</td></tr> <tr><td>Volumen Neto</td><td>18.65</td></tr> </table>	ABSCISA		Area en Corte	1.93	Area	0.00	Volumen en Corte	1.88	Volumen en Relleno	0.00	Volumen Acomulado En Corte	18.65	Volumen Acomulado En Relleno	0.00	Volumen Neto	18.65	<p>0+019.00</p> <table border="1"> <tr><th colspan="2">ABSCISA</th></tr> <tr><td>Area en Corte</td><td>1.98</td></tr> <tr><td>Area</td><td>0.00</td></tr> <tr><td>Volumen en Corte</td><td>1.95</td></tr> <tr><td>Volumen en Relleno</td><td>0.00</td></tr> <tr><td>Volumen Acomulado En Corte</td><td>20.61</td></tr> <tr><td>Volumen Acomulado En Relleno</td><td>0.00</td></tr> <tr><td>Volumen Neto</td><td>20.61</td></tr> </table>	ABSCISA		Area en Corte	1.98	Area	0.00	Volumen en Corte	1.95	Volumen en Relleno	0.00	Volumen Acomulado En Corte	20.61	Volumen Acomulado En Relleno	0.00	Volumen Neto	20.61	<p>0+020.00</p> <table border="1"> <tr><th colspan="2">ABSCISA</th></tr> <tr><td>Area en Corte</td><td>1.66</td></tr> <tr><td>Area</td><td>0.00</td></tr> <tr><td>Volumen en Corte</td><td>1.58</td></tr> <tr><td>Volumen en Relleno</td><td>0.00</td></tr> <tr><td>Volumen Acomulado En Corte</td><td>13.09</td></tr> <tr><td>Volumen Acomulado En Relleno</td><td>0.00</td></tr> <tr><td>Volumen Neto</td><td>13.09</td></tr> </table>	ABSCISA		Area en Corte	1.66	Area	0.00	Volumen en Corte	1.58	Volumen en Relleno	0.00	Volumen Acomulado En Corte	13.09	Volumen Acomulado En Relleno	0.00	Volumen Neto	13.09	<p>0+018.00</p> <table border="1"> <tr><th colspan="2">ABSCISA</th></tr> <tr><td>Area en Corte</td><td>1.93</td></tr> <tr><td>Area</td><td>0.00</td></tr> <tr><td>Volumen en Corte</td><td>1.88</td></tr> <tr><td>Volumen en Relleno</td><td>0.00</td></tr> <tr><td>Volumen Acomulado En Corte</td><td>18.65</td></tr> <tr><td>Volumen Acomulado En Relleno</td><td>0.00</td></tr> <tr><td>Volumen Neto</td><td>18.65</td></tr> </table>	ABSCISA		Area en Corte	1.93	Area	0.00	Volumen en Corte	1.88	Volumen en Relleno	0.00	Volumen Acomulado En Corte	18.65	Volumen Acomulado En Relleno	0.00	Volumen Neto	18.65	<p>0+019.00</p> <table border="1"> <tr><th colspan="2">ABSCISA</th></tr> <tr><td>Area en Corte</td><td>1.98</td></tr> <tr><td>Area</td><td>0.00</td></tr> <tr><td>Volumen en Corte</td><td>1.95</td></tr> <tr><td>Volumen en Relleno</td><td>0.00</td></tr> <tr><td>Volumen Acomulado En Corte</td><td>20.61</td></tr> <tr><td>Volumen Acomulado En Relleno</td><td>0.00</td></tr> <tr><td>Volumen Neto</td><td>20.61</td></tr> </table>	ABSCISA		Area en Corte	1.98	Area	0.00	Volumen en Corte	1.95	Volumen en Relleno	0.00	Volumen Acomulado En Corte	20.61	Volumen Acomulado En Relleno	0.00	Volumen Neto	20.61	<p>0+020.00</p> <table border="1"> <tr><th colspan="2">ABSCISA</th></tr> <tr><td>Area en Corte</td><td>1.96</td></tr> <tr><td>Area</td><td>0.00</td></tr> <tr><td>Volumen en Corte</td><td>1.97</td></tr> <tr><td>Volumen en Relleno</td><td>0.00</td></tr> <tr><td>Volumen Acomulado En Corte</td><td>22.57</td></tr> <tr><td>Volumen Acomulado En Relleno</td><td>0.00</td></tr> <tr><td>Volumen Neto</td><td>22.57</td></tr> </table>	ABSCISA		Area en Corte	1.96	Area	0.00	Volumen en Corte	1.97	Volumen en Relleno	0.00	Volumen Acomulado En Corte	22.57	Volumen Acomulado En Relleno	0.00	Volumen Neto	22.57
ABSCISA																																																																																																																																																																																										
Area en Corte	0.58																																																																																																																																																																																									
Area	0.00																																																																																																																																																																																									
Volumen en Corte	0.49																																																																																																																																																																																									
Volumen en Relleno	0.00																																																																																																																																																																																									
Volumen Acomulado En Corte	0.88																																																																																																																																																																																									
Volumen Acomulado En Relleno	0.00																																																																																																																																																																																									
Volumen Neto	0.88																																																																																																																																																																																									
ABSCISA																																																																																																																																																																																										
Area en Corte	0.76																																																																																																																																																																																									
Area	0.00																																																																																																																																																																																									
Volumen en Corte	0.67																																																																																																																																																																																									
Volumen en Relleno	0.00																																																																																																																																																																																									
Volumen Acomulado En Corte	1.55																																																																																																																																																																																									
Volumen Acomulado En Relleno	0.00																																																																																																																																																																																									
Volumen Neto	1.55																																																																																																																																																																																									
ABSCISA																																																																																																																																																																																										
Area en Corte	0.96																																																																																																																																																																																									
Area	0.00																																																																																																																																																																																									
Volumen en Corte	0.86																																																																																																																																																																																									
Volumen en Relleno	0.00																																																																																																																																																																																									
Volumen Acomulado En Corte	2.41																																																																																																																																																																																									
Volumen Acomulado En Relleno	0.00																																																																																																																																																																																									
Volumen Neto	2.41																																																																																																																																																																																									
ABSCISA																																																																																																																																																																																										
Area en Corte	1.30																																																																																																																																																																																									
Area	0.00																																																																																																																																																																																									
Volumen en Corte	1.20																																																																																																																																																																																									
Volumen en Relleno	0.00																																																																																																																																																																																									
Volumen Acomulado En Corte	10.09																																																																																																																																																																																									
Volumen Acomulado En Relleno	0.00																																																																																																																																																																																									
Volumen Neto	10.09																																																																																																																																																																																									
ABSCISA																																																																																																																																																																																										
Area en Corte	1.51																																																																																																																																																																																									
Area	0.00																																																																																																																																																																																									
Volumen en Corte	1.41																																																																																																																																																																																									
Volumen en Relleno	0.00																																																																																																																																																																																									
Volumen Acomulado En Corte	11.50																																																																																																																																																																																									
Volumen Acomulado En Relleno	0.00																																																																																																																																																																																									
Volumen Neto	11.50																																																																																																																																																																																									
ABSCISA																																																																																																																																																																																										
Area en Corte	1.93																																																																																																																																																																																									
Area	0.00																																																																																																																																																																																									
Volumen en Corte	1.88																																																																																																																																																																																									
Volumen en Relleno	0.00																																																																																																																																																																																									
Volumen Acomulado En Corte	18.65																																																																																																																																																																																									
Volumen Acomulado En Relleno	0.00																																																																																																																																																																																									
Volumen Neto	18.65																																																																																																																																																																																									
ABSCISA																																																																																																																																																																																										
Area en Corte	1.98																																																																																																																																																																																									
Area	0.00																																																																																																																																																																																									
Volumen en Corte	1.95																																																																																																																																																																																									
Volumen en Relleno	0.00																																																																																																																																																																																									
Volumen Acomulado En Corte	20.61																																																																																																																																																																																									
Volumen Acomulado En Relleno	0.00																																																																																																																																																																																									
Volumen Neto	20.61																																																																																																																																																																																									
ABSCISA																																																																																																																																																																																										
Area en Corte	1.66																																																																																																																																																																																									
Area	0.00																																																																																																																																																																																									
Volumen en Corte	1.58																																																																																																																																																																																									
Volumen en Relleno	0.00																																																																																																																																																																																									
Volumen Acomulado En Corte	13.09																																																																																																																																																																																									
Volumen Acomulado En Relleno	0.00																																																																																																																																																																																									
Volumen Neto	13.09																																																																																																																																																																																									
ABSCISA																																																																																																																																																																																										
Area en Corte	1.93																																																																																																																																																																																									
Area	0.00																																																																																																																																																																																									
Volumen en Corte	1.88																																																																																																																																																																																									
Volumen en Relleno	0.00																																																																																																																																																																																									
Volumen Acomulado En Corte	18.65																																																																																																																																																																																									
Volumen Acomulado En Relleno	0.00																																																																																																																																																																																									
Volumen Neto	18.65																																																																																																																																																																																									
ABSCISA																																																																																																																																																																																										
Area en Corte	1.98																																																																																																																																																																																									
Area	0.00																																																																																																																																																																																									
Volumen en Corte	1.95																																																																																																																																																																																									
Volumen en Relleno	0.00																																																																																																																																																																																									
Volumen Acomulado En Corte	20.61																																																																																																																																																																																									
Volumen Acomulado En Relleno	0.00																																																																																																																																																																																									
Volumen Neto	20.61																																																																																																																																																																																									
ABSCISA																																																																																																																																																																																										
Area en Corte	1.96																																																																																																																																																																																									
Area	0.00																																																																																																																																																																																									
Volumen en Corte	1.97																																																																																																																																																																																									
Volumen en Relleno	0.00																																																																																																																																																																																									
Volumen Acomulado En Corte	22.57																																																																																																																																																																																									
Volumen Acomulado En Relleno	0.00																																																																																																																																																																																									
Volumen Neto	22.57																																																																																																																																																																																									

FISCALIZACIÓN

CONTRATISTA

" CONSTRUCCIÓN DE LOS HANGARES DEL GOBIERNO AUTÓNOMO DESCENTRALIZADO PROVINCIAL DE PASTAZA
(GADPPz) | ETAPA, PARROQUIA FÁTIMA, CANTÓN Y PROVINCIA DE PASTAZA "

ANEXO: 15

RUBRO 23
DESCRIPCIÓN DESARROLLO MECANICO VOLQUETA TIERRAESCOMBROS
UNIDAD m3
PERIODO 1 DE JUNIO 2021 A 30 DE JUNIO 2021



PROYECTO:	0+006.00	0+007.00	0+008.00	0+015.16	0+015.84	0+021.00	0+021.00	0+022.00	0+022.00	0+023.00	0+023.00
SECCIONES DE CORTE											
ABSCISA	990	990	990	991	991	991	991	991	991	991	991
Area en Corte	1.18	1.16	1.11	1.68	1.70	1.68	1.68	1.82	1.82	2.21	2.21
Area	0.00	0.00	0.00	0.00	0.00	0.00	0.00	0.00	0.00	0.00	0.00
Volumen en Corte	1.07	1.17	1.13	0.27	0.44	1.67	1.67	1.85	1.85	2.02	2.02
Volumen en Relleno	0.00	0.00	0.00	0.00	0.00	0.00	0.00	0.00	0.00	0.00	0.00
Volumen Acumulado En Corte	3.48	4.65	5.78	15.02	15.46	14.76	14.76	26.33	26.33	28.35	28.35
Volumen Acumulado En Relleno	0.00	0.00	0.00	0.00	0.00	0.00	0.00	0.00	0.00	0.00	0.00
Volumen Neto	3.48	4.65	5.78	15.02	15.46	14.76	14.76	26.33	26.33	28.35	28.35

[Signature]
FISCALIZACIÓN

[Signature]
CONTRATISTA

GOBIERNO AUTÓNOMO DESCENTRALIZADO DE PASTAZA
PROVINCIA DEL PASTAZA

"CONSTRUCCIÓN DE LOS HANGARES DEL GOBIERNO AUTÓNOMO DESCENTRALIZADO PROVINCIAL DE PASTAZA (GADPPz) | ETAPA, PARROQUIA FÁTIMA, CANTÓN Y PROVINCIA DE PASTAZA "

ANEXO: 16

RUBRO 23
 DESCRIPCION DESALOJO MECANICO VOLQUETA TIERRA/ESCOBROS
 UNIDAD m3
 PERIODO 1 DE JUNIO 2021 A 30 DE JUNIO 2021



0+024.00
SECCIONES DE CORTE

ABSCISA	
Area en Corte	2.72
Area	0.00
Volumen en Corte	2.47
Volumen en Relleno	0.00
Volumen Acomulado En Corte	30.82
Volumen Acomulado En Relleno	0.00
Volumen Neto	30.82

0+033.00
SECCIONES DE CORTE

ABSCISA	
Area en Corte	3.95
Area	0.00
Volumen en Corte	3.96
Volumen en Relleno	0.00
Volumen Acomulado En Corte	62.81
Volumen Acomulado En Relleno	0.00
Volumen Neto	62.81

0+042.00
SECCIONES DE CORTE

ABSCISA	
Area en Corte	4.12
Area	0.00
Volumen en Corte	4.22
Volumen en Relleno	0.00
Volumen Acomulado En Corte	101.36
Volumen Acomulado En Relleno	0.00
Volumen Neto	101.36

0+048.00
SECCIONES DE CORTE

ABSCISA	
Area en Corte	3.29
Area	0.00
Volumen en Corte	2.18
Volumen en Relleno	0.00
Volumen Acomulado En Corte	119.66
Volumen Acomulado En Relleno	0.00
Volumen Neto	119.66

0+025.00
SECCIONES DE CORTE

ABSCISA	
Area en Corte	3.09
Area	0.00
Volumen en Corte	2.91
Volumen en Relleno	0.00
Volumen Acomulado En Corte	33.72
Volumen Acomulado En Relleno	0.00
Volumen Neto	33.72

0+034.00
SECCIONES DE CORTE

ABSCISA	
Area en Corte	3.86
Area	0.00
Volumen en Corte	3.90
Volumen en Relleno	0.00
Volumen Acomulado En Corte	66.71
Volumen Acomulado En Relleno	0.00
Volumen Neto	66.71

0+043.00
SECCIONES DE CORTE

ABSCISA	
Area en Corte	3.89
Area	0.00
Volumen en Corte	4.01
Volumen en Relleno	0.00
Volumen Acomulado En Corte	105.37
Volumen Acomulado En Relleno	0.00
Volumen Neto	105.37

0+049.00
SECCIONES DE CORTE

ABSCISA	
Area en Corte	3.82
Area	0.00
Volumen en Corte	3.55
Volumen en Relleno	0.00
Volumen Acomulado En Corte	123.21
Volumen Acomulado En Relleno	0.00
Volumen Neto	123.21

0+026.00
SECCIONES DE CORTE

ABSCISA	
Area en Corte	3.16
Area	0.00
Volumen en Corte	3.12
Volumen en Relleno	0.00
Volumen Acomulado En Corte	36.85
Volumen Acomulado En Relleno	0.00
Volumen Neto	36.85

0+035.00
SECCIONES DE CORTE

ABSCISA	
Area en Corte	3.82
Area	0.00
Volumen en Corte	3.84
Volumen en Relleno	0.00
Volumen Acomulado En Corte	70.54
Volumen Acomulado En Relleno	0.00
Volumen Neto	70.54

0+044.00
SECCIONES DE CORTE

ABSCISA	
Area en Corte	3.63
Area	0.00
Volumen en Corte	3.76
Volumen en Relleno	0.00
Volumen Acomulado En Corte	109.13
Volumen Acomulado En Relleno	0.00
Volumen Neto	109.13

0+050.00
SECCIONES DE CORTE

ABSCISA	
Area en Corte	4.10
Area	0.00
Volumen en Corte	3.96
Volumen en Relleno	0.00
Volumen Acomulado En Corte	127.17
Volumen Acomulado En Relleno	0.00
Volumen Neto	127.17

CONTRATISTA

FISCALIZACIÓN

"CONSTRUCCIÓN DE LOS HANGARES DEL GOBIERNO AUTÓNOMO DESCENTRALIZADO PROVINCIAL DE PASTAZA
(GADPPz) | ETAPA, PARROQUIA FÁTIMA, CANTÓN Y PROVINCIA DE PASTAZA "



ANEXO: 17

RUBRO 23
DESCRIPCIÓN DESARROLLO MECANICO VOLQUETA TIERRAESCOMBROS
UNIDAD m3
PERIODO 1 DE JUNIO 2021 A 30 DE JUNIO 2021

PROYECTO:

SECCIONES DE CORTE	SECCIONES DE CORTE	SECCIONES DE CORTE	SECCIONES DE CORTE	SECCIONES DE CORTE	SECCIONES DE CORTE	SECCIONES DE CORTE	SECCIONES DE CORTE	SECCIONES DE CORTE	SECCIONES DE CORTE																																																																																																																																																																																																		
 <table border="1"> <tr><th colspan="2">ABSCISA</th></tr> <tr><td>Area en Corte</td><td>3.30</td></tr> <tr><td>Area</td><td>0.00</td></tr> <tr><td>Volumen en Corte</td><td>3.23</td></tr> <tr><td>Volumen en Relleno</td><td>0.00</td></tr> <tr><td>Volumen Acumulado En Corte</td><td>40.0</td></tr> <tr><td>Volumen Acumulado En Relleno</td><td>0.00</td></tr> <tr><td>Volumen Neto</td><td>40.0</td></tr> </table>	ABSCISA		Area en Corte	3.30	Area	0.00	Volumen en Corte	3.23	Volumen en Relleno	0.00	Volumen Acumulado En Corte	40.0	Volumen Acumulado En Relleno	0.00	Volumen Neto	40.0	 <table border="1"> <tr><th colspan="2">ABSCISA</th></tr> <tr><td>Area en Corte</td><td>4.11</td></tr> <tr><td>Area</td><td>0.00</td></tr> <tr><td>Volumen en Corte</td><td>3.97</td></tr> <tr><td>Volumen en Relleno</td><td>0.00</td></tr> <tr><td>Volumen Acumulado En Corte</td><td>74.53</td></tr> <tr><td>Volumen Acumulado En Relleno</td><td>0.00</td></tr> <tr><td>Volumen Neto</td><td>74.53</td></tr> </table>	ABSCISA		Area en Corte	4.11	Area	0.00	Volumen en Corte	3.97	Volumen en Relleno	0.00	Volumen Acumulado En Corte	74.53	Volumen Acumulado En Relleno	0.00	Volumen Neto	74.53	 <table border="1"> <tr><th colspan="2">ABSCISA</th></tr> <tr><td>Area en Corte</td><td>3.39</td></tr> <tr><td>Area</td><td>0.00</td></tr> <tr><td>Volumen en Corte</td><td>1.88</td></tr> <tr><td>Volumen en Relleno</td><td>0.00</td></tr> <tr><td>Volumen Acumulado En Corte</td><td>112.06</td></tr> <tr><td>Volumen Acumulado En Relleno</td><td>0.00</td></tr> <tr><td>Volumen Neto</td><td>112.06</td></tr> </table>	ABSCISA		Area en Corte	3.39	Area	0.00	Volumen en Corte	1.88	Volumen en Relleno	0.00	Volumen Acumulado En Corte	112.06	Volumen Acumulado En Relleno	0.00	Volumen Neto	112.06	 <table border="1"> <tr><th colspan="2">ABSCISA</th></tr> <tr><td>Area en Corte</td><td>3.59</td></tr> <tr><td>Area</td><td>0.00</td></tr> <tr><td>Volumen en Corte</td><td>3.84</td></tr> <tr><td>Volumen en Relleno</td><td>0.00</td></tr> <tr><td>Volumen Acumulado En Corte</td><td>131.01</td></tr> <tr><td>Volumen Acumulado En Relleno</td><td>0.00</td></tr> <tr><td>Volumen Neto</td><td>131.01</td></tr> </table>	ABSCISA		Area en Corte	3.59	Area	0.00	Volumen en Corte	3.84	Volumen en Relleno	0.00	Volumen Acumulado En Corte	131.01	Volumen Acumulado En Relleno	0.00	Volumen Neto	131.01	 <table border="1"> <tr><th colspan="2">ABSCISA</th></tr> <tr><td>Area en Corte</td><td>3.54</td></tr> <tr><td>Area</td><td>0.00</td></tr> <tr><td>Volumen en Corte</td><td>3.42</td></tr> <tr><td>Volumen en Relleno</td><td>0.00</td></tr> <tr><td>Volumen Acumulado En Corte</td><td>43.4</td></tr> <tr><td>Volumen Acumulado En Relleno</td><td>0.00</td></tr> <tr><td>Volumen Neto</td><td>43.4</td></tr> </table>	ABSCISA		Area en Corte	3.54	Area	0.00	Volumen en Corte	3.42	Volumen en Relleno	0.00	Volumen Acumulado En Corte	43.4	Volumen Acumulado En Relleno	0.00	Volumen Neto	43.4	 <table border="1"> <tr><th colspan="2">ABSCISA</th></tr> <tr><td>Area en Corte</td><td>4.63</td></tr> <tr><td>Area</td><td>0.00</td></tr> <tr><td>Volumen en Corte</td><td>4.37</td></tr> <tr><td>Volumen en Relleno</td><td>0.00</td></tr> <tr><td>Volumen Acumulado En Corte</td><td>78.90</td></tr> <tr><td>Volumen Acumulado En Relleno</td><td>0.00</td></tr> <tr><td>Volumen Neto</td><td>78.90</td></tr> </table>	ABSCISA		Area en Corte	4.63	Area	0.00	Volumen en Corte	4.37	Volumen en Relleno	0.00	Volumen Acumulado En Corte	78.90	Volumen Acumulado En Relleno	0.00	Volumen Neto	78.90	 <table border="1"> <tr><th colspan="2">ABSCISA</th></tr> <tr><td>Area en Corte</td><td>3.16</td></tr> <tr><td>Area</td><td>0.00</td></tr> <tr><td>Volumen en Corte</td><td>2.00</td></tr> <tr><td>Volumen en Relleno</td><td>0.00</td></tr> <tr><td>Volumen Acumulado En Corte</td><td>114.06</td></tr> <tr><td>Volumen Acumulado En Relleno</td><td>0.00</td></tr> <tr><td>Volumen Neto</td><td>114.06</td></tr> </table>	ABSCISA		Area en Corte	3.16	Area	0.00	Volumen en Corte	2.00	Volumen en Relleno	0.00	Volumen Acumulado En Corte	114.06	Volumen Acumulado En Relleno	0.00	Volumen Neto	114.06	 <table border="1"> <tr><th colspan="2">ABSCISA</th></tr> <tr><td>Area en Corte</td><td>3.48</td></tr> <tr><td>Area</td><td>0.00</td></tr> <tr><td>Volumen en Corte</td><td>3.53</td></tr> <tr><td>Volumen en Relleno</td><td>0.00</td></tr> <tr><td>Volumen Acumulado En Corte</td><td>134.54</td></tr> <tr><td>Volumen Acumulado En Relleno</td><td>0.00</td></tr> <tr><td>Volumen Neto</td><td>134.54</td></tr> </table>	ABSCISA		Area en Corte	3.48	Area	0.00	Volumen en Corte	3.53	Volumen en Relleno	0.00	Volumen Acumulado En Corte	134.54	Volumen Acumulado En Relleno	0.00	Volumen Neto	134.54	 <table border="1"> <tr><th colspan="2">ABSCISA</th></tr> <tr><td>Area en Corte</td><td>3.75</td></tr> <tr><td>Area</td><td>0.00</td></tr> <tr><td>Volumen en Corte</td><td>3.64</td></tr> <tr><td>Volumen en Relleno</td><td>0.00</td></tr> <tr><td>Volumen Acumulado En Corte</td><td>47.1</td></tr> <tr><td>Volumen Acumulado En Relleno</td><td>0.00</td></tr> <tr><td>Volumen Neto</td><td>47.1</td></tr> </table>	ABSCISA		Area en Corte	3.75	Area	0.00	Volumen en Corte	3.64	Volumen en Relleno	0.00	Volumen Acumulado En Corte	47.1	Volumen Acumulado En Relleno	0.00	Volumen Neto	47.1	 <table border="1"> <tr><th colspan="2">ABSCISA</th></tr> <tr><td>Area en Corte</td><td>4.71</td></tr> <tr><td>Area</td><td>0.00</td></tr> <tr><td>Volumen en Corte</td><td>4.67</td></tr> <tr><td>Volumen en Relleno</td><td>0.00</td></tr> <tr><td>Volumen Acumulado En Corte</td><td>83.57</td></tr> <tr><td>Volumen Acumulado En Relleno</td><td>0.00</td></tr> <tr><td>Volumen Neto</td><td>83.57</td></tr> </table>	ABSCISA		Area en Corte	4.71	Area	0.00	Volumen en Corte	4.67	Volumen en Relleno	0.00	Volumen Acumulado En Corte	83.57	Volumen Acumulado En Relleno	0.00	Volumen Neto	83.57	 <table border="1"> <tr><th colspan="2">ABSCISA</th></tr> <tr><td>Area en Corte</td><td>3.11</td></tr> <tr><td>Area</td><td>0.00</td></tr> <tr><td>Volumen en Corte</td><td>0.50</td></tr> <tr><td>Volumen en Relleno</td><td>0.00</td></tr> <tr><td>Volumen Acumulado En Corte</td><td>114.55</td></tr> <tr><td>Volumen Acumulado En Relleno</td><td>0.00</td></tr> <tr><td>Volumen Neto</td><td>114.55</td></tr> </table>	ABSCISA		Area en Corte	3.11	Area	0.00	Volumen en Corte	0.50	Volumen en Relleno	0.00	Volumen Acumulado En Corte	114.55	Volumen Acumulado En Relleno	0.00	Volumen Neto	114.55	 <table border="1"> <tr><th colspan="2">ABSCISA</th></tr> <tr><td>Area en Corte</td><td>3.27</td></tr> <tr><td>Area</td><td>0.00</td></tr> <tr><td>Volumen en Corte</td><td>3.37</td></tr> <tr><td>Volumen en Relleno</td><td>0.00</td></tr> <tr><td>Volumen Acumulado En Corte</td><td>137.91</td></tr> <tr><td>Volumen Acumulado En Relleno</td><td>0.00</td></tr> <tr><td>Volumen Neto</td><td>137.91</td></tr> </table>	ABSCISA		Area en Corte	3.27	Area	0.00	Volumen en Corte	3.37	Volumen en Relleno	0.00	Volumen Acumulado En Corte	137.91	Volumen Acumulado En Relleno	0.00	Volumen Neto	137.91
ABSCISA																																																																																																																																																																																																											
Area en Corte	3.30																																																																																																																																																																																																										
Area	0.00																																																																																																																																																																																																										
Volumen en Corte	3.23																																																																																																																																																																																																										
Volumen en Relleno	0.00																																																																																																																																																																																																										
Volumen Acumulado En Corte	40.0																																																																																																																																																																																																										
Volumen Acumulado En Relleno	0.00																																																																																																																																																																																																										
Volumen Neto	40.0																																																																																																																																																																																																										
ABSCISA																																																																																																																																																																																																											
Area en Corte	4.11																																																																																																																																																																																																										
Area	0.00																																																																																																																																																																																																										
Volumen en Corte	3.97																																																																																																																																																																																																										
Volumen en Relleno	0.00																																																																																																																																																																																																										
Volumen Acumulado En Corte	74.53																																																																																																																																																																																																										
Volumen Acumulado En Relleno	0.00																																																																																																																																																																																																										
Volumen Neto	74.53																																																																																																																																																																																																										
ABSCISA																																																																																																																																																																																																											
Area en Corte	3.39																																																																																																																																																																																																										
Area	0.00																																																																																																																																																																																																										
Volumen en Corte	1.88																																																																																																																																																																																																										
Volumen en Relleno	0.00																																																																																																																																																																																																										
Volumen Acumulado En Corte	112.06																																																																																																																																																																																																										
Volumen Acumulado En Relleno	0.00																																																																																																																																																																																																										
Volumen Neto	112.06																																																																																																																																																																																																										
ABSCISA																																																																																																																																																																																																											
Area en Corte	3.59																																																																																																																																																																																																										
Area	0.00																																																																																																																																																																																																										
Volumen en Corte	3.84																																																																																																																																																																																																										
Volumen en Relleno	0.00																																																																																																																																																																																																										
Volumen Acumulado En Corte	131.01																																																																																																																																																																																																										
Volumen Acumulado En Relleno	0.00																																																																																																																																																																																																										
Volumen Neto	131.01																																																																																																																																																																																																										
ABSCISA																																																																																																																																																																																																											
Area en Corte	3.54																																																																																																																																																																																																										
Area	0.00																																																																																																																																																																																																										
Volumen en Corte	3.42																																																																																																																																																																																																										
Volumen en Relleno	0.00																																																																																																																																																																																																										
Volumen Acumulado En Corte	43.4																																																																																																																																																																																																										
Volumen Acumulado En Relleno	0.00																																																																																																																																																																																																										
Volumen Neto	43.4																																																																																																																																																																																																										
ABSCISA																																																																																																																																																																																																											
Area en Corte	4.63																																																																																																																																																																																																										
Area	0.00																																																																																																																																																																																																										
Volumen en Corte	4.37																																																																																																																																																																																																										
Volumen en Relleno	0.00																																																																																																																																																																																																										
Volumen Acumulado En Corte	78.90																																																																																																																																																																																																										
Volumen Acumulado En Relleno	0.00																																																																																																																																																																																																										
Volumen Neto	78.90																																																																																																																																																																																																										
ABSCISA																																																																																																																																																																																																											
Area en Corte	3.16																																																																																																																																																																																																										
Area	0.00																																																																																																																																																																																																										
Volumen en Corte	2.00																																																																																																																																																																																																										
Volumen en Relleno	0.00																																																																																																																																																																																																										
Volumen Acumulado En Corte	114.06																																																																																																																																																																																																										
Volumen Acumulado En Relleno	0.00																																																																																																																																																																																																										
Volumen Neto	114.06																																																																																																																																																																																																										
ABSCISA																																																																																																																																																																																																											
Area en Corte	3.48																																																																																																																																																																																																										
Area	0.00																																																																																																																																																																																																										
Volumen en Corte	3.53																																																																																																																																																																																																										
Volumen en Relleno	0.00																																																																																																																																																																																																										
Volumen Acumulado En Corte	134.54																																																																																																																																																																																																										
Volumen Acumulado En Relleno	0.00																																																																																																																																																																																																										
Volumen Neto	134.54																																																																																																																																																																																																										
ABSCISA																																																																																																																																																																																																											
Area en Corte	3.75																																																																																																																																																																																																										
Area	0.00																																																																																																																																																																																																										
Volumen en Corte	3.64																																																																																																																																																																																																										
Volumen en Relleno	0.00																																																																																																																																																																																																										
Volumen Acumulado En Corte	47.1																																																																																																																																																																																																										
Volumen Acumulado En Relleno	0.00																																																																																																																																																																																																										
Volumen Neto	47.1																																																																																																																																																																																																										
ABSCISA																																																																																																																																																																																																											
Area en Corte	4.71																																																																																																																																																																																																										
Area	0.00																																																																																																																																																																																																										
Volumen en Corte	4.67																																																																																																																																																																																																										
Volumen en Relleno	0.00																																																																																																																																																																																																										
Volumen Acumulado En Corte	83.57																																																																																																																																																																																																										
Volumen Acumulado En Relleno	0.00																																																																																																																																																																																																										
Volumen Neto	83.57																																																																																																																																																																																																										
ABSCISA																																																																																																																																																																																																											
Area en Corte	3.11																																																																																																																																																																																																										
Area	0.00																																																																																																																																																																																																										
Volumen en Corte	0.50																																																																																																																																																																																																										
Volumen en Relleno	0.00																																																																																																																																																																																																										
Volumen Acumulado En Corte	114.55																																																																																																																																																																																																										
Volumen Acumulado En Relleno	0.00																																																																																																																																																																																																										
Volumen Neto	114.55																																																																																																																																																																																																										
ABSCISA																																																																																																																																																																																																											
Area en Corte	3.27																																																																																																																																																																																																										
Area	0.00																																																																																																																																																																																																										
Volumen en Corte	3.37																																																																																																																																																																																																										
Volumen en Relleno	0.00																																																																																																																																																																																																										
Volumen Acumulado En Corte	137.91																																																																																																																																																																																																										
Volumen Acumulado En Relleno	0.00																																																																																																																																																																																																										
Volumen Neto	137.91																																																																																																																																																																																																										



CONTRATISTA

FISCALIZACIÓN

" CONSTRUCCIÓN DE LOS HANGARES DEL GOBIERNO AUTÓNOMO DESCENTRALIZADO PROVINCIAL DE PASTAZA
(GADPPZ) | ETAPA, PARROQUIA FÁTIMA, CANTÓN Y PROVINCIA DE PASTAZA "

23

ANEXO: 18



RUBRO 23
DESCRIPCIÓN DESALDO MECANICO VOLQUETA TIERRA/ESCOBROS
UNIDAD m3
PERIODO 1 DE JUNIO 2021 A 30 DE JUNIO 2021

PROYECTO:

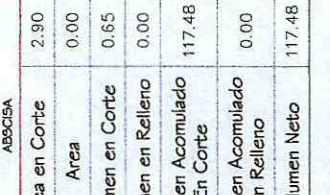
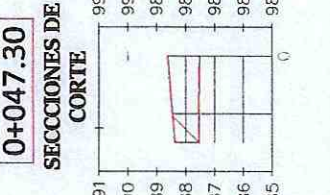
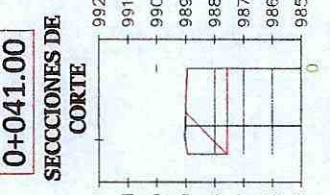
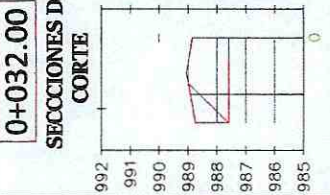
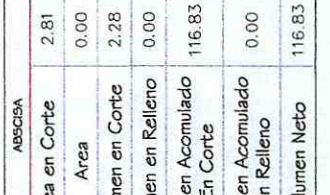
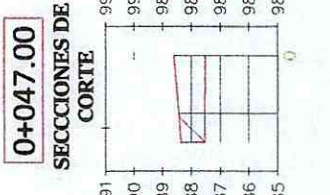
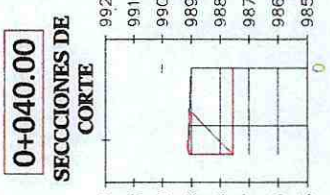
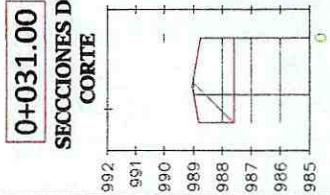
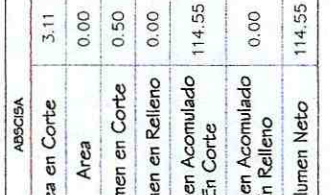
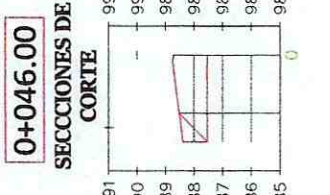
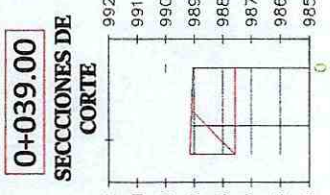
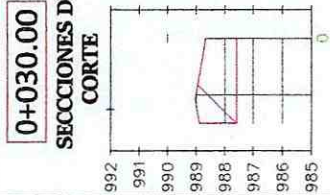

CONTRATISTA

FISCALIZACIÓN

" CONSTRUCCIÓN DE LOS HANGARES DEL GOBIERNO AUTÓNOMO DESCENTRALIZADO PROVINCIAL DE PASTAZA
(GADPPz) I ETAPA, PARROQUIA FÁTIMA, CANTÓN Y PROVINCIA DE PASTAZA "

ANEXO: 19

RUBRO 23
DESCRIPCION DESALOJO MECANICO VOLQUETA TIERRASCOMBROS
UNIDAD m3
PERIODO 1 DE JUNIO 2021 A 30 DE JUNIO 2021



PROYECTO:

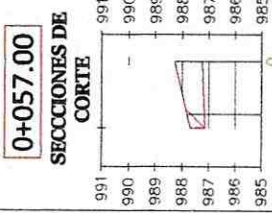

ASCICIA	
Area en Corte	1.97
Area	0.00
Volumen en Corte	2.27
Volumen en Relleno	0.00
Volumen Acomulado En Corte	149.03
Volumen Acomulado En Relleno	0.00
Volumen Neto	149.03

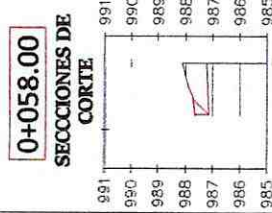

ASCICIA	
Area en Corte	1.32
Area	0.00
Volumen en Corte	1.64
Volumen en Relleno	0.00
Volumen Acomulado En Corte	150.67
Volumen Acomulado En Relleno	0.00
Volumen Neto	150.67

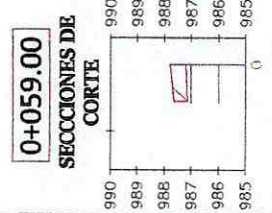

ASCICIA	
Area en Corte	0.73
Area	0.00
Volumen en Corte	1.02
Volumen en Relleno	0.00
Volumen Acomulado En Corte	151.70
Volumen Acomulado En Relleno	0.00
Volumen Neto	151.70

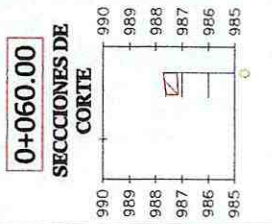

ASCICIA	
Area en Corte	0.40
Area	0.00
Volumen en Corte	0.57
Volumen en Relleno	0.00
Volumen Acomulado En Corte	152.26
Volumen Acomulado En Relleno	0.00
Volumen Neto	152.26

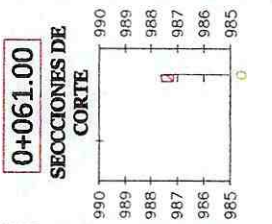

ASCICIA	
Area en Corte	0.11
Area	0.00
Volumen en Corte	0.26
Volumen en Relleno	0.00
Volumen Acomulado En Corte	152.52
Volumen Acomulado En Relleno	0.00
Volumen Neto	152.52

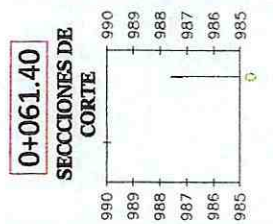

ASCICIA	
Area en Corte	0.01
Area	0.00
Volumen en Corte	0.03
Volumen en Relleno	0.00
Volumen Acomulado En Corte	152.54
Volumen Acomulado En Relleno	0.00
Volumen Neto	152.54

CONTRATISTA

FISCALIZACIÓN

GOBIERNO AUTÓNOMO DESCENTRALIZADO DE LA PROVINCIA DEL PASTAZA

PROYECTO

“CONSTRUCCIÓN DE LOS HANGARES DEL GOBIERNO AUTÓNOMO DESCENTRALIZADO PROVINCIAL DE PASTAZA (GADPPZ) I ETAPA, PARROQUIA FÁTIMA, CANTÓN Y PROVINCIA DE PASTAZA”

PLANILLA DE AVANCE DE OBRA No. 23

RUBRO N° 41
 DESCRIPCIÓN: ENTIBADO DE ZANJA
 UNIDAD: m2
 PERIODO: 01-jun 30-jun

ANEXO 1



ENTIBADO DE ZANJA						
DESCRIPCION	LARGO (X)	ANCHO (Y)	ALTO (Z)	No.	SUBTOTAL	TOTAL
TUBERIA DIAMETRO 364 RED PRINCIPAL						
TRAMO 5	26,00		2,00	1,00	52,00	52,00
TRAMO 6	54,00		2,00	1,00	108,00	108,00
					TOTAL	160,00

RESUMEN DE PLANILLA AL 100%					
DESCRIPCION	CONTRATADO	ANTERIOR	ACTUAL	ACUMULADO	UNIDAD
ENTIBADO DE ZANJA	160,00	-	160,00	160,00	m2



 CONTRATISTA

 FISCALIZACIÓN

BIERNO AUTONOMO DESCENTRALIZADO DE LA PROVINCIA DEL PASTAZA

" CONSTRUCCIÓN DE LOS HANGARES DEL GOBIERNO AUTÓNOMO DESCENTRALIZADO PROVINCIAL DE PASTAZA (GADPPz) I ETAPA, PARROQUIA FÁTIMA, CANTÓN Y PROVINCIA DE PASTAZA "

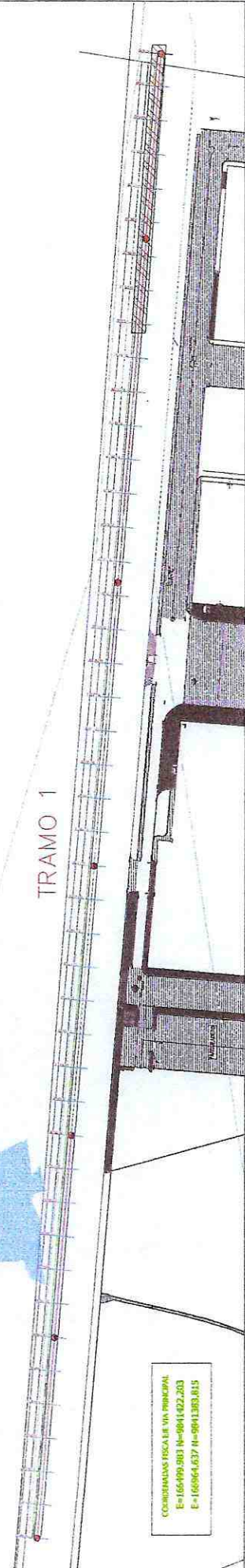
PROYECTO:	ANEXO: 1		
RUBRO	41		
DESCRIPCION	ENTIBADO DE ZANJA		
UNIDAD	m ²		
PERIODO	1 DE JUNIO 2021 A 30 DE JUNIO 2021		



UBICACIÓN: RED DE ALCANTARILLADO SANITARIO

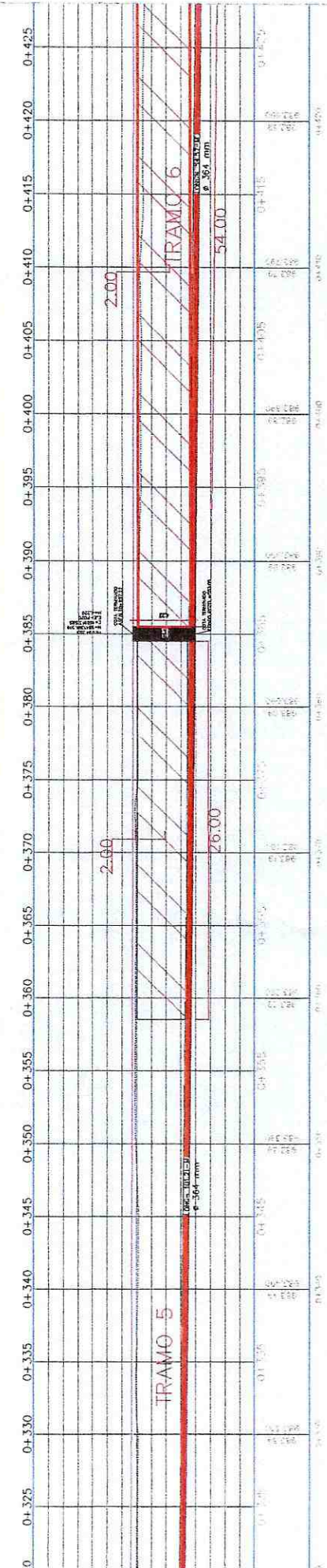

CONTRATISTA

VIA PRINCIPAL DE ANCHO 18mts

FISCALIZACIÓN

GOBIERNO AUTÓNOMO DESCENTRALIZADO DE LA PROVINCIA DEL PASTAZA

PROYECTO " CONSTRUCCIÓN DE LOS HANGARES DEL GOBIERNO AUTÓNOMO DESCENTRALIZADO PROVINCIAL DE PASTAZA (GADPPz) I ETAPA, PARROQUIA FÁTIMA, CANTÓN Y PROVINCIA DE PASTAZA "

PLANILLA DE AVANCE DE OBRA No. 23

RUBRO N° 42
 DESCRIPCIÓN: RAZANTEO DE ZANJA E= 0.20m
 UNIDAD: m2
 PERIODO: 01-jun 30-jun

ANEXO 1



PAG. 1 DE 1

RAZANTEO DE ZANJA E= 0.20m						
DESCRIPCION	LARGO (X)	VOLUMEN		No.	SUBTOTAL	TOTAL
TUBERIA DIAMETRO 364 RED PRINCIPAL						
TRAMO 4	84,00			1,00	47,00	47,00
TRAMO 5	99,00			1,00	99,00	99,00
TRAMO 6	54,00			1,00	54,00	54,00
TOTAL					200,00	200,00
ANCHO CONSTANTE					1,20	
TOTAL					240,00	240,00

RESUMEN DE PLANILLA AL 100%					
DESCRIPCION	CONTRATADO	ANTERIOR	ACTUAL	ACUMULADO	UNIDAD
RAZANTEO DE ZANJA E= 0.20m	240,00	-	240,00	240,00	m2

 CONTRATISTA

 FISCALIZACIÓN

BIEN GOBIERNO AUTONOMO DESCENTRALIZADO DE LA PROVINCIA DEL PASTAZA

* CONSTRUCCIÓN DE LOS HANGARES DEL GOBIERNO AUTÓNOMO DESCENTRALIZADO PROVINCIAL DE PASTAZA (GADPPz) I ETAPA, PARROQUIA FÁTIMA, CANTÓN Y PROVINCIA DE PASTAZA *

PROYECTO:	ANEXO: 1
RUBRO	42
DESCRIPCION	RAZANTEO DE ZANJA E= 0.20m
UNIDAD	m ²
PERIODO	1 DE JUNIO 2021 A 30 DE JUNIO 2021



TRAMO 1

440.00

COORDINADAS TÍPICAS DE LA PRINCIPAL
E= 166499.583 N= 9041422.203
E= 166954.637 N= 9041383.815

UBICACIÓN: RED DE ALCANTARILLADO SANITARIO
RELLENO COMPACTADO A
MAQUINA CON LASTRE TNm=8"
(EN CAPAS DE 20 Cm)

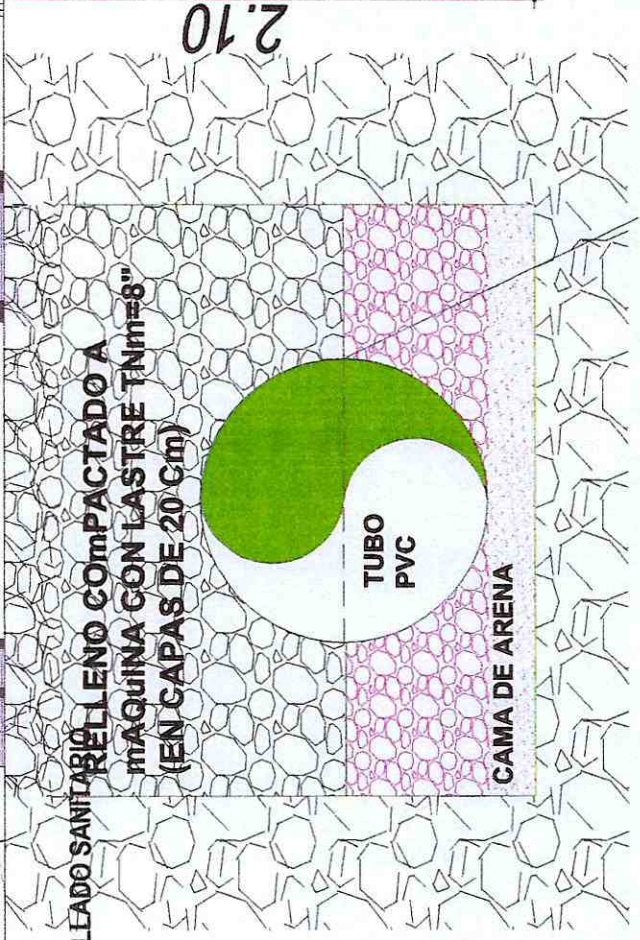

CONTRATISTA

VIA PRINCIPAL DE ANCHO 18mts

REGISTRACIÓN

BIEN GOBIERNO AUTÓNOMO DESCENTRALIZADO DE LA PROVINCIA DEL PASTAZA

"CONSTRUCCIÓN DE LOS HANGARES DEL GOBIERNO AUTÓNOMO DESCENTRALIZADO PROVINCIAL DE PASTAZA (GADPPz) [ETAPA, PARROQUIA FÁTIMA, CANTÓN Y PROVINCIA DE PASTAZA]"



ANEXO: 2

42 RAZANTEO DE ZANJA E= 0.20m
m2
1 DE JUNIO 2021 A 30 DE JUNIO 2021

PROYECTO:

RUBRO
DESCRIPCION
UNIDAD
PERIODO

0+220	0+225	0+230	0+235	0+240	0+245	0+250	0+255	0+260	0+265	0+270	0+275	0+280	0+285	0+290	0+295	0+300	0+305	0+310	0+315	0+320	0+325	0+3
TRAMO 4																						
42 RAZANTEO DE ZANJA E= 0.20m m2 1 DE JUNIO 2021 A 30 DE JUNIO 2021																						
47.00																						

0+325	0+330	0+335	0+340	0+345	0+350	0+355	0+360	0+365	0+370	0+375	0+380	0+385	0+390	0+395	0+400	0+405	0+410	0+415	0+420	0+425		
TRAMO 5																					TRAMO 6	
42 RAZANTEO DE ZANJA E= 0.20m m2 1 DE JUNIO 2021 A 30 DE JUNIO 2021																					42 RAZANTEO DE ZANJA E= 0.20m m2 1 DE JUNIO 2021 A 30 DE JUNIO 2021	
39.00																					54.00	

CONTRATISTA

FISCALIZACIÓN

GOBIERNO AUTÓNOMO DESCENTRALIZADO DE LA PROVINCIA DEL PASTAZA

PROYECTO " CONSTRUCCIÓN DE LOS HANGARES DEL GOBIERNO AUTÓNOMO DESCENTRALIZADO PROVINCIAL DE PASTAZA (GADPPz) I ETAPA, PARROQUIA FÁTIMA, CANTÓN Y PROVINCIA DE PLANILLA DE AVANCE DE OBRA No. 23

RUBRO N° 61 ANEXO 1
 DESCRIPCIÓN: ENTIBADO DE ZANJA
 UNIDAD: m2
 PERIODO: 01-jun 30-jun



ENTIBADO DE ZANJA						
ENTIBADO DE LA RED DE EVACUACION DE AGUA LLUVIS DREN						
DESCRIPCION	LARGO (X)	ANCHO (Y)	ALTO (Z)	No.	SUBTOTAL	TOTAL
A1	62,5		2	2	250	250
					TOTAL 1	250,00

RESUMEN DE PLANILLA AL 100%					
DESCRIPCION	CONTRATADO	ANTERIOR	ACTUAL	ACUMULADO	UNIDAD
ENTIBADO DE ZANJA	308,42	58,42	250,00	308,42	m2

CONTRATISTA

FISCALIZACIÓN

GOBIERNO AUTÓNOMO DESCENTRALIZADO DE LA PROVINCIA DEL PASTAZA

" CONSTRUCCIÓN DE LOS HANGARES DEL GOBIERNO AUTÓNOMO DESCENTRALIZADO PROVINCIAL DE PASTAZA (GADPPz) I ETAPA, PARROQUIA FÁTIMA, CANTÓN Y PROVINCIA DE PASTAZA "

PROYECTO:	
RUBRO	61
DESCRIPCION	ENTIBADO DE ZANJA
UNIDAD	m ²
PERIODO	1 DE JUNIO 2021 A 30 DE JUNIO 2021

ANEXO: 1

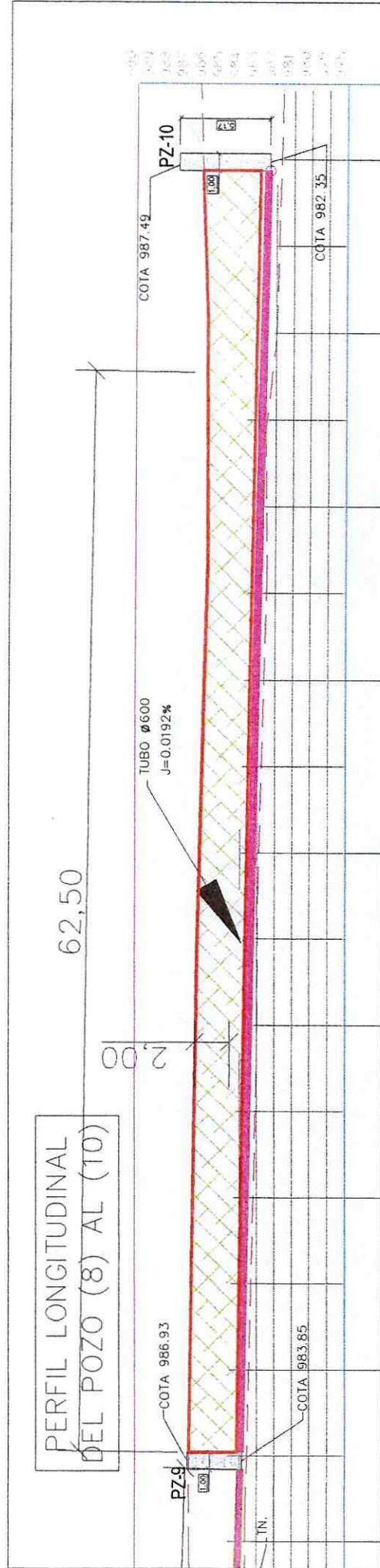
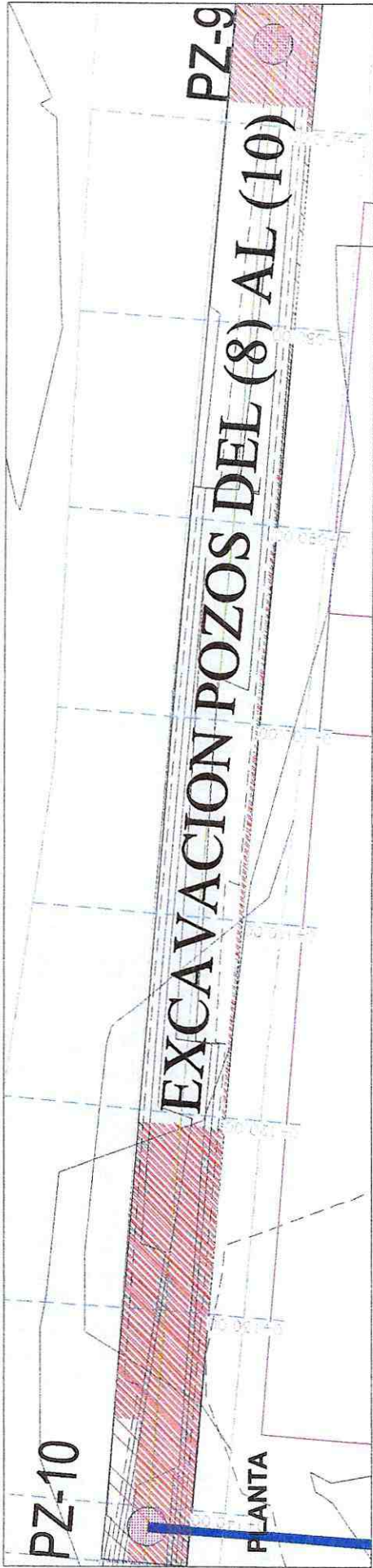
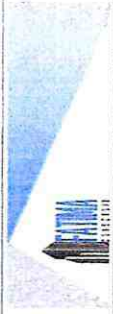

[Signature]
CONTRATISTA

[Signature]
FISCALIZACIÓN

GOBIERNO AUTÓNOMO DESCENTRALIZADO DE LA PROVINCIA DEL PASTAZA

PROYECTO " CONSTRUCCIÓN DE LOS HANGARES DEL GOBIERNO AUTÓNOMO DESCENTRALIZADO PROVINCIAL DE PASTAZA (GADPPz) I ETAPA, PARROQUIA FÁTIMA, CANTÓN Y PROVINCIA DE PASTAZA "

PLANILLA DE AVANCE DE OBRA No. 23

RUBRO N° 62
 DESCRIPCIÓN: RAZANTEO DE ZANJA E= 0.20m
 UNIDAD: m2
 PERIODO: 01-jun 30-jun

ANEXO 1



PAG. 1 DE 1

RAZANTEO DE ZANJA E= 0.20m						
ACOMETIDAS DOMICILIARIAS EN LA VIA PRINCIPAL RED PLUVIAL						
DESCRIPCION	LARGO (X)	VOLUMEN	No.	SUBTOTAL	TOTAL	
TUBERIA DIAMETRO 160 ACOMETIDAS						
LOTE 1	9,60		1,00	9,60	9,60	
LOTE 2-6	11,00		5,00	55,00	55,00	
LOTE 7-15	11,14		7,00	78,00	78,00	
TUBERIA DIAMETRO 364 ACOMETIDAS						
ESCUELA DEL MILENIO	10,00		2,00	20,00	20,00	
TUBERIA DIAMETRO 364 SUMIDEROS Y VIAS						
S1	5,70		9,00	51,30	51,30	
S2	7,20		1,00	7,20	7,20	
S3	7,95		1,00	7,95	7,95	
S4	7,82		1,00	7,82	7,82	
S5	6,90		2,00	13,80	13,80	
V1	16,00		1,00	16,00	16,00	
V2	16,00		1,00	16,00	16,00	
TUBERIA DIAMETRO 400 RED PRINCIPAL						
TRAMO 1	70,00		1,00	70,00	70,00	
TRAMO 2	72,50		1,00	72,50	72,50	
TRAMO 2	72,50		1,00	72,50	72,50	
TRAMO 3	78,13		1,00	78,13	78,13	
TRAMO 3	64,90		1,00	64,90	64,90	
TRAMO 4	14,30		1,00	14,30	14,30	
TRAMO 5	20,50		1,00	20,50	20,50	
TRAMO 6	32,00		1,00	32,00	32,00	
				SUBTOTAL	707,50	
				ANCHO CONSTANTE	1,20	
				TOTAL	849,00	

RESUMEN DE PLANILLA AL 100%					
DESCRIPCION	CONTRATADO	ANTERIOR	ACTUAL	ACUMULADO	UNIDAD
RAZANTEO DE ZANJA E= 0.20m	849,00	-	849,00	849,00	m2



 CONTRATISTA

 FISCALIZACIÓN

BIEN AUTÓNOMO DESCENTRALIZADO DE LA PROVINCIA DEL PASTAZA

* CONSTRUCCIÓN DE LOS HANGARES DEL GOBIERNO AUTÓNOMO DESCENTRALIZADO PROVINCIAL DE PASTAZA (GADPPZ) | ETAPA, PARROQUIA FÁTIMA, CANTÓN Y PROVINCIA DE PASTAZA *

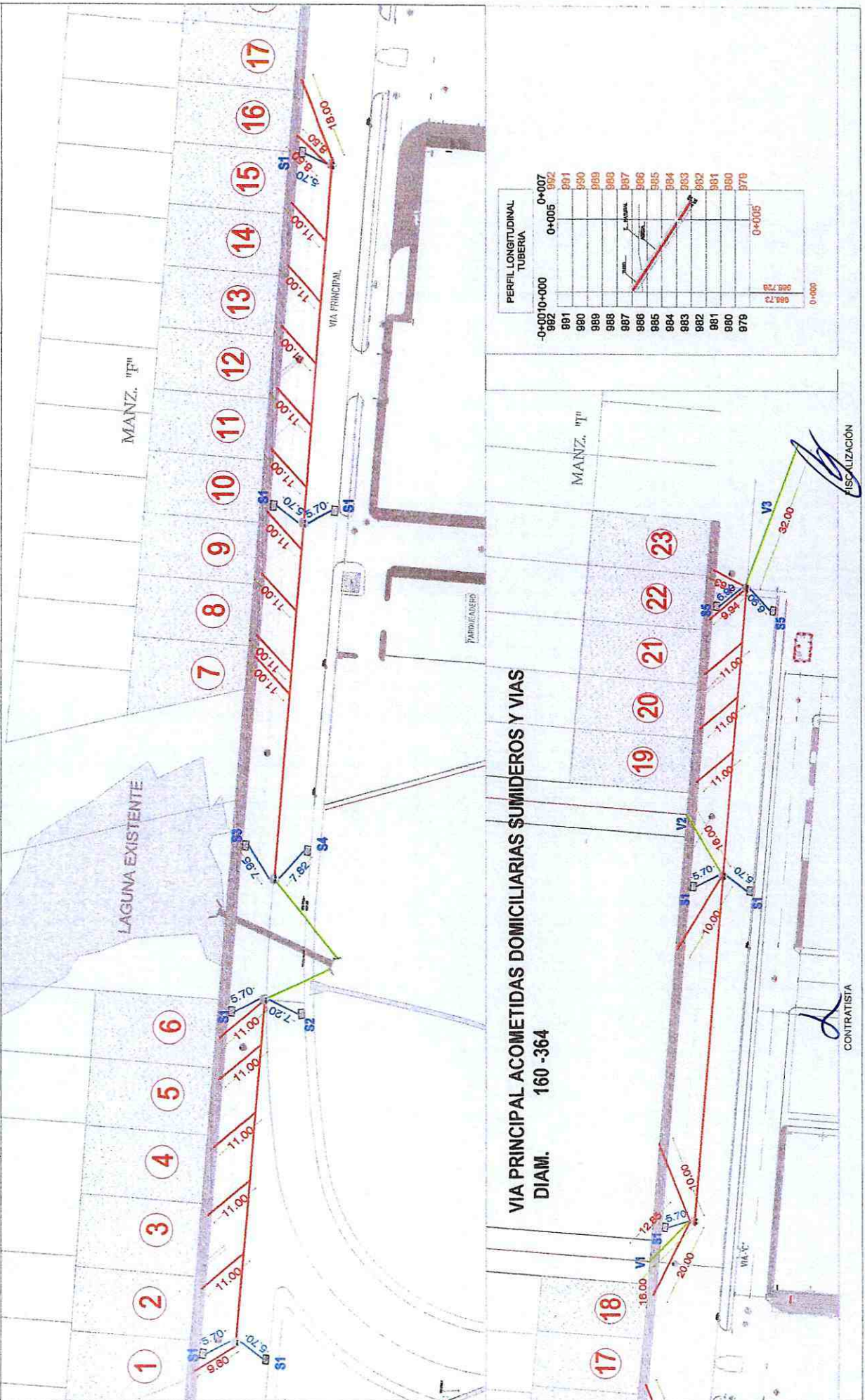
PROYECTO:	ANEXO: 1
RUBRO	62
DESCRIPCION	RAZANTEO DE ZANJA E= 0.20m
UNIDAD	m ²
PERIODO	1 DE JUNIO 2021 A 30 DE JUNIO 2021



CONTRATISTA

INSERCIÓN

GOBIERNO AUTONOMO DESCENTRALIZADO DE LA
 PROVINCIA DEL PASTAZA

"CONSTRUCCIÓN DE LOS HANGARES DEL GOBIERNO AUTÓNOMO DESCENTRALIZADO PROVINCIAL DE PASTAZA
 (GADPPz) I ETAPA, PARROQUIA FÁTIMA, CANTÓN Y PROVINCIA DE PASTAZA "

RUBRO	62
DESCRIPCION	RAZANTEO DE ZANJA E= 0.20m
UNIDAD	m2
PERIODO	1 DE JUNIO 2021 A 30 DE JUNIO 2021

ANEXO: 2

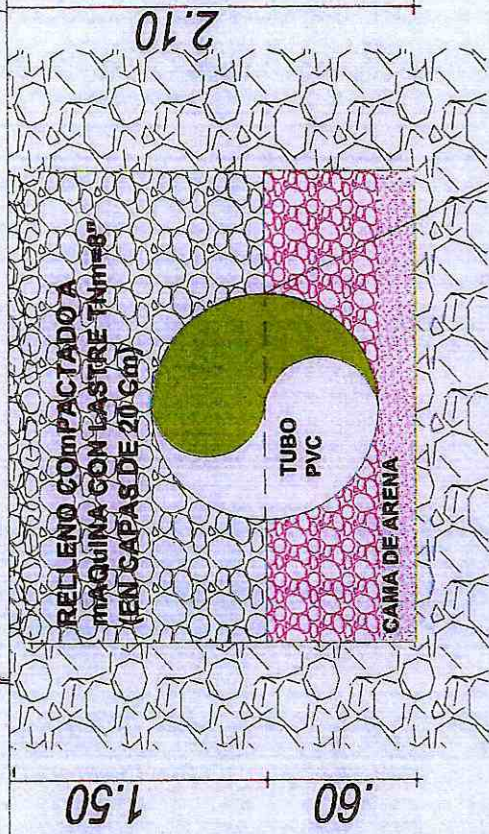
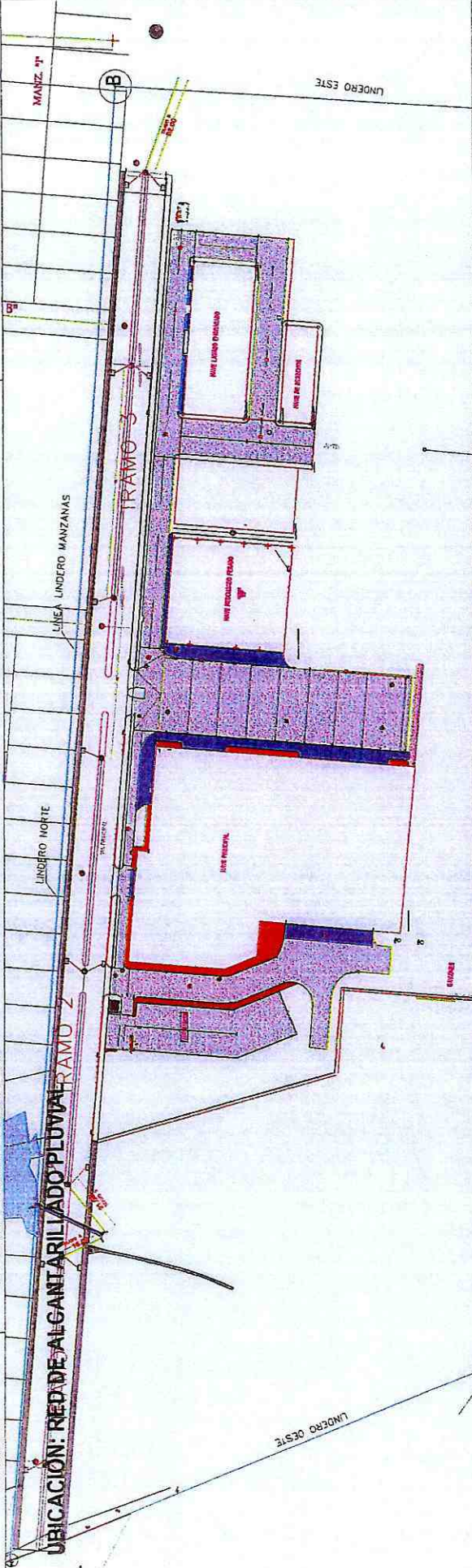

1.20

CONTRATISTA

VIA PRINCIPAL DE ANCHO 18mts

FISCALIZACION

GOBIERNO AUTÓNOMO DESCENTRALIZADO DE LA
PROVINCIA DEL PASTAZA

" CONSTRUCCIÓN DE LOS HANGARES DEL GOBIERNO AUTÓNOMO DESCENTRALIZADO PROVINCIAL DE PASTAZA
 (GADPPz) I ETAPA, PARROQUIA FÁTIMA, CANTÓN Y PROVINCIA DE PASTAZA "

PROYECTO:	
RUBRO	ANEXO: 3
DESCRIPCION	RAZANTEO DE ZANJA E= 0.20m
UNIDAD	m2
PERIODO	1 DE JUNIO 2021 A 30 DE JUNIO 2021

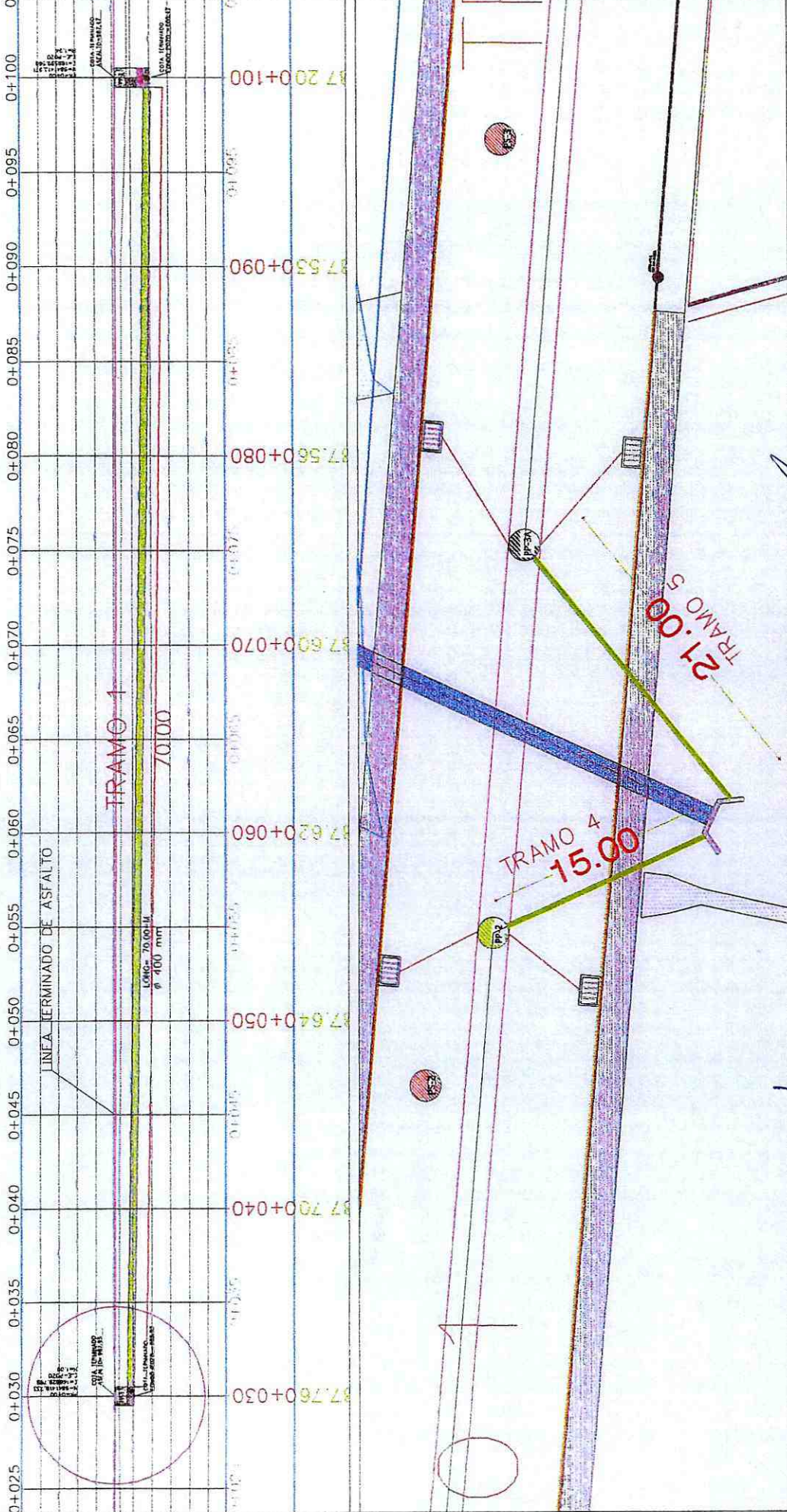

VIA PRINCIPAL DE ANCHO 18mts

FISCALIZACIÓN

CONTRATISTA

"CONSTRUCCIÓN DE LOS HANGARES DEL GOBIERNO AUTÓNOMO DESCENTRALIZADO PROVINCIAL DE PASTAZA (GADPPZ) I ETAPA, PARROQUIA FÁTIMA, CANTÓN Y PROVINCIA DE PASTAZA"

ANEXO: 4	
RUBRO	62
DESCRIPCION	RAZANTEO DE ZANJA E= 0.20m
UNIDAD	m ²
PERIODO	1 DE JUNIO 2021 A 30 DE JUNIO 2021

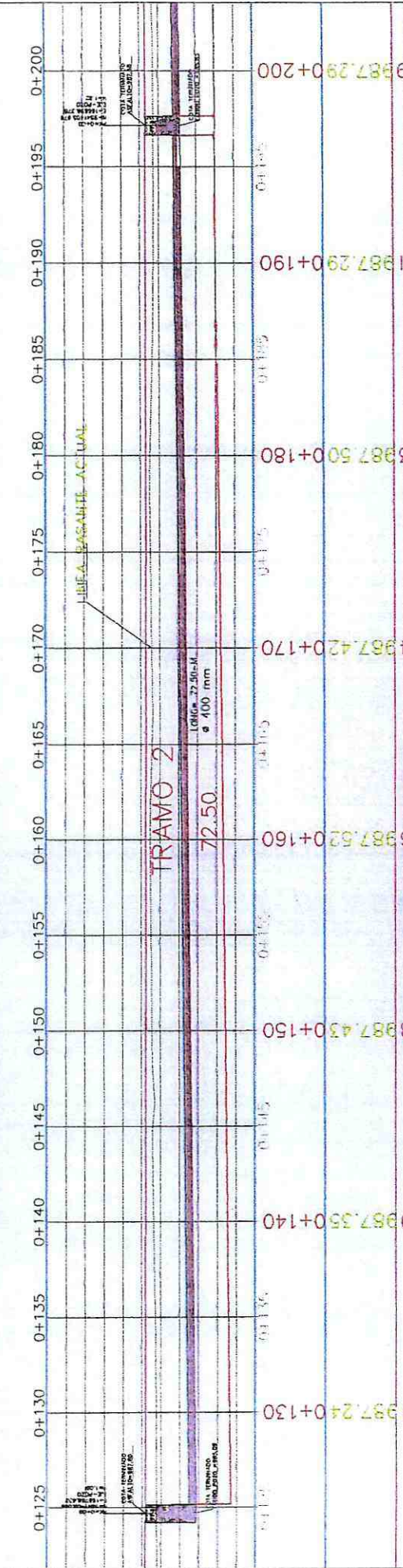

VIA PRINCIPAL

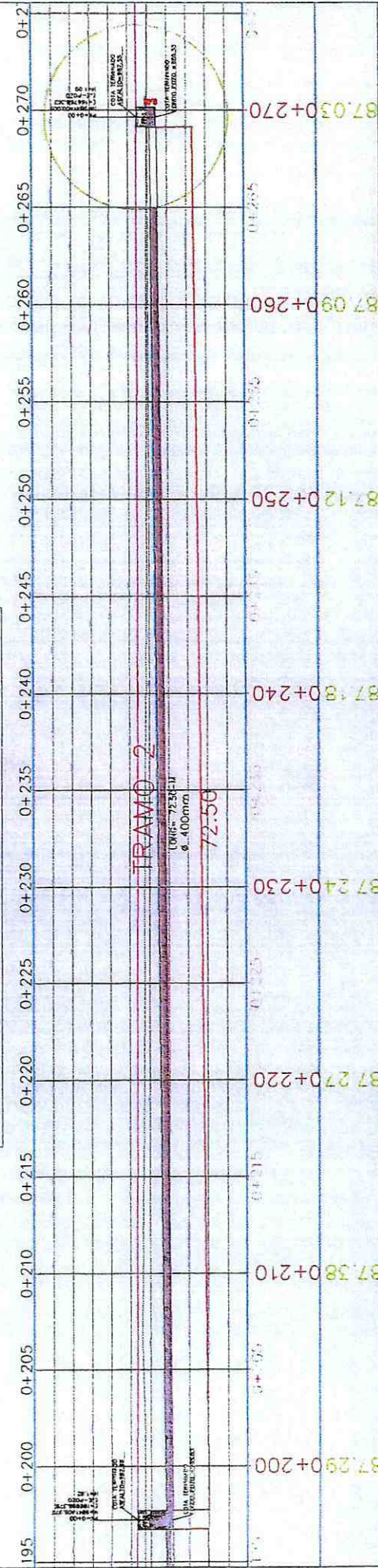

UBICACION: RED DE ALCANTARILLADO SANITARIO

VIA PRINCIPAL DE ANCHO 18mts

CONTRATISTA

FISCALIZACION

GOBIERNO AUTÓNOMO DESCENTRALIZADO DE PASTAZA
 PROVINCIA DEL PASTAZA

* CONSTRUCCIÓN DE LOS HANGARES DEL GOBIERNO AUTÓNOMO DESCENTRALIZADO PROVINCIAL DE PASTAZA
 (GADPPP) I ETAPA, PARROQUIA FÁTIMA, CANTÓN Y PROVINCIA DE PASTAZA *

PROYECTO:			
RUBRO	62	ANEXO: 5	
DESCRIPCION	RAZANTEO DE ZANJA E= 0.20m		
UNIDAD	m2		
PERIODO	1 DE JUNIO 2021 A 30 DE JUNIO 2021		

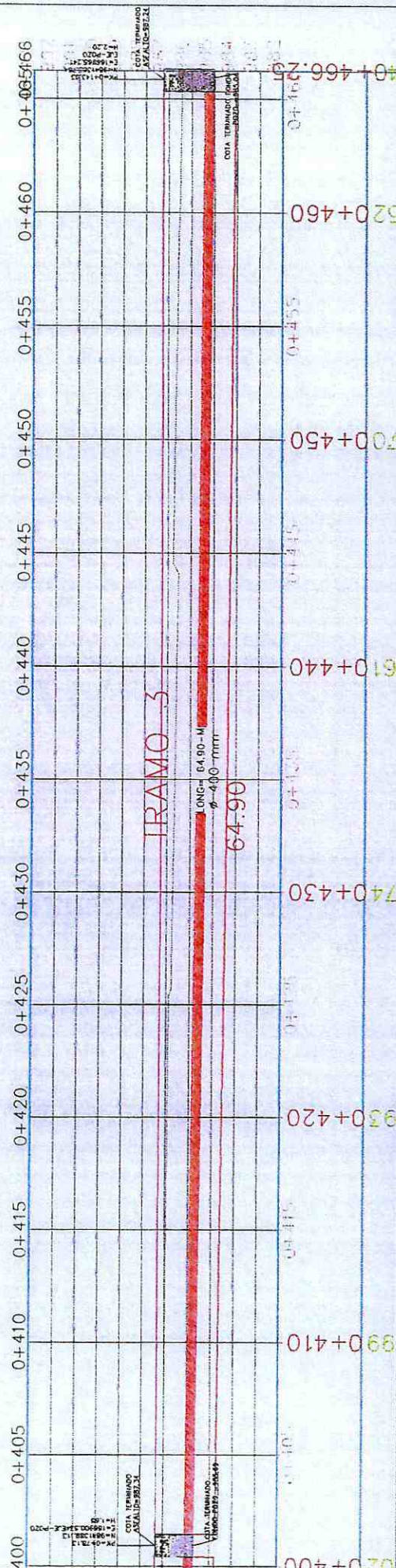
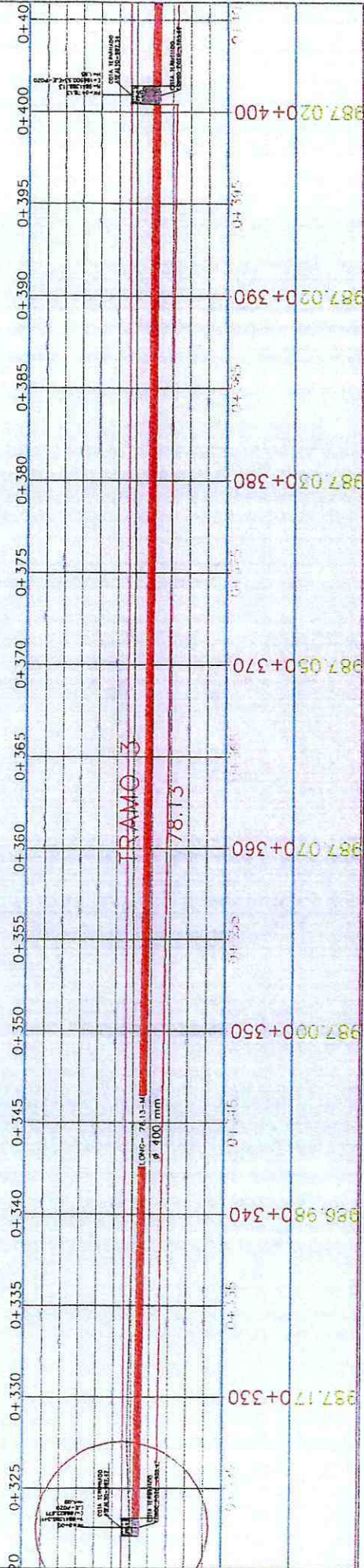

UBICACIÓN: RED DE ALCANTARILLADO SANITARIO

VIA PRINCIPAL DE ANCHO 18mts

[Signature]
 CONTRATISTA

[Signature]
 FISCALIZACIÓN

GOBIERNO AUTÓNOMO DESCENTRALIZADO DE LA PROVINCIA DEL PASTAZA

PROYECTO * CONSTRUCCIÓN DE LOS HANGARES DEL GOBIERNO AUTÓNOMO DESCENTRALIZADO PROVINCIAL DE PASTAZA (GADPP2) I ETAPA, PARROQUIA FÁTIMA, CANTÓN Y PROVINCIA DE PASTAZA *

PLANILLA DE AVANCE DE OBRA N° 23

RUBRO N° 120 ANEXO 1
 DESCRIPCIÓN: TRATAMIENTO PINTURA ESTRUCTURA ACERO A36 (FONDO+PINTURA ANTICORROSIVA), A COMPRESOR
 UNIDAD: Kg
 PERIODO: 01-jul 31-jul



TRÁMITE PRINCIPAL (BLOQUE ADMINISTRATIVO)

PÁG. 3 DE 9

ACERO A 572 - GRADOS 50		DIMENSIONES (mm)							LONGITUD (mm)				OBSERVACIONES
MC	H'	a/mm	e/mm	r/mm	PERIMETRO/m	SECCIÓN/mm ²	Kg/m ³	PESO/ML (kg/m)	LONGITUD (mm)	SUB-TOTAL	TOTAL PESO (KG)		
COLUMNAS BLOQUE ADMINISTRATIVO N+0,30 AL N+9,88													
COLUMNAS DE EJE 1-7 / A-I											90085,27		
TOTAL (KG)											90085,27		
VIGAS BLOQUE ADMINISTRATIVO N+5,09													
VIGAS PRINCIPALES HORIZONTALES N+5,09											16251,82		
VIGAS PRINCIPALES VERTICALES N+5,09											8526,94		
VIGAS SECUNDARIAS VERTICALES N+5,09											15614,39		
VIGAS SECUNDARIAS DE ESCALERA Y VOLADO N+5,09											1514,58		
TOTAL (KG)											41907,73		
VIGAS BLOQUE ADMINISTRATIVO N+9,88													
VIGAS PRINCIPALES HORIZONTALES N+9,88											14515,16		
VIGAS PRINCIPALES VERTICALES N+9,88											7844,62		
VIGAS SECUNDARIAS VERTICALES N+9,88											1469,55		
TOTAL (KG)											23829,33		

RESUMEN DE PLANILLA AL 100%

DESCRIPCIÓN	CONTRATADO	ANTERIOR	ACTUAL	ACUMULADO	UNIDAD
TRATAMIENTO PINTURA ESTRUCTURA ACERO A36 (FONDO+PINTURA ANTICORROSIVA)	499.962,86	344.120,53	155.842,33	499.962,86	Kg

CONTRATISTA

FISCALIZACION

GOBIERNO AUTÓNOMO DESCENTRALIZADO DE LA PROVINCIA DEL PASTAZA

PROYECTO * CONSTRUCCIÓN DE LOS HANGARES DEL GOBIERNO AUTÓNOMO DESCENTRALIZADO PROVINCIAL DE PASTAZA (GADPP2) I ETAPA, PARROQUIA FÁTIMA, CANTÓN Y PROVINCIA DE PLANILLA DE AVANCE DE OBRA N° 23

RUBRO N° 120 ANEXO 2
 DESCRPCION: TRATAMIENTO PINTURA ESTRUCTURA ACERO A36
 UNIDAD: Kg
 PERIODO: 01-jul 31-jul



PAG. 2 DE 9

PLANILLA DE ELEMENTOS PARA PLANTA ADMINISTRATIVA (COLUMNAS)
 ACERO LAMINADO EN FRIO PARA COLUMNAS ; ASTM A572 GRADO 50

COLUM	EJES	TIPO	N°	DIMENSIONES (mm)			LONGITUD (m)		SECCION - RADIO CURVATURA(m2)	VOLUMEN (m3)	DENSIDAD A572 (kg/m3)	PESO TOTAL (kg)	DESCRIPCIÓN
				H	B	e	PARCIAL	TOTAL					
1	A1	2C	1	450	225	15	9,7	9,7	0,0259069	0,2513	7850	1972,71	CLA-03
2	B1	2C	1	450	225	12	9,7	9,7	0,0209004	0,2027	7850	1591,20	CLA-01
3	C1	2C	1	450	225	12	9,7	9,7	0,0209004	0,2027	7850	1591,20	CLA-01
4	D1	2C	1	450	225	12	9,7	9,7	0,0209004	0,2027	7850	1591,20	CLA-01
5	E1	2C	1	450	225	12	9,7	9,7	0,0209004	0,2027	7850	1591,20	CLA-01
6	F1	2C	1	450	225	12	9,7	9,7	0,0209004	0,2027	7850	1591,20	CLA-01
7	G1	2C	1	450	225	15	9,7	9,7	0,0259069	0,2513	7850	1972,71	CLA-03
8	H1'	2C	1	450	225	12	4,9	4,9	0,0209004	0,1024	7850	803,84	CLA-02
9	A2	2C	1	450	225	12	9,7	9,7	0,0209004	0,2027	7850	1591,20	CLA-01
10	B2	2C	1	450	225	15	4,9	4,9	0,0259069	0,1269	7850	996,17	CLA-04
11	C2	2C	1	450	225	15	9,7	9,7	0,0259069	0,2513	7850	1972,71	CLA-03
12	D2	2C	1	450	225	15	9,7	9,7	0,0259069	0,2513	7850	1972,71	CLA-03
13	E2	2C	1	450	225	15	9,7	9,7	0,0259069	0,2513	7850	1972,71	CLA-03
14	F2	2C	1	450	225	15	9,7	9,7	0,0259069	0,2513	7850	1972,71	CLA-03
15	G2	2C	1	450	225	12	9,7	9,7	0,0209004	0,2027	7850	1591,20	CLA-01
16	H2	2C	1	450	225	12	4,9	4,9	0,0209004	0,1024	7850	803,84	CLA-02
17	I2	2C	1	450	225	15	4,9	4,9	0,0259069	0,1269	7850	996,17	CLA-04
18	A3	2C	1	450	225	12	9,7	9,7	0,0209004	0,2027	7850	1591,20	CLA-01
19	B3	2C	1	450	225	15	4,9	4,9	0,0259069	0,1269	7850	996,17	CLA-04
20	C3	2C	1	450	225	15	9,7	9,7	0,0259069	0,2513	7850	1972,71	CLA-03
21	D3	2C	1	450	225	15	9,7	9,7	0,0259069	0,2513	7850	1972,71	CLA-03
22	E3	2C	1	450	225	15	9,7	9,7	0,0259069	0,2513	7850	1972,71	CLA-03
23	F3	2C	1	450	225	15	9,7	9,7	0,0259069	0,2513	7850	1972,71	CLA-03
24	G3	2C	1	450	225	12	9,7	9,7	0,0209004	0,2027	7850	1591,20	CLA-01
25	H3	2C	1	450	225	12	4,9	4,9	0,0209004	0,1024	7850	803,84	CLA-02
26	I3	2C	1	450	225	12	4,9	4,9	0,0209004	0,1024	7850	803,84	CLA-02
27	A4	2C	1	450	225	15	9,7	9,7	0,0259069	0,2513	7850	1972,71	CLA-03
28	B4	2C	1	450	225	12	9,7	9,7	0,0209004	0,2027	7850	1591,20	CLA-01
29	C4	2C	1	450	225	12	9,7	9,7	0,0209004	0,2027	7850	1591,20	CLA-01
30	D4	2C	1	450	225	12	9,7	9,7	0,0209004	0,2027	7850	1591,20	CLA-01
31	E4	2C	1	450	225	12	9,7	9,7	0,0209004	0,2027	7850	1591,20	CLA-01
32	F4	2C	1	450	225	12	9,7	9,7	0,0209004	0,2027	7850	1591,20	CLA-01
33	G4	2C	1	450	225	15	9,7	9,7	0,0259069	0,2513	7850	1972,71	CLA-03
34	H4	2C	1	450	225	12	4,9	4,9	0,0209004	0,1024	7850	803,84	CLA-02
35	I4	2C	1	450	225	15	4,9	4,9	0,0259069	0,1269	7850	996,17	CLA-04
36	D5	2C	1	450	225	15	9,7	9,7	0,0259069	0,2513	7850	1972,71	CLA-03
37	E5	2C	1	450	225	15	9,7	9,7	0,0259069	0,2513	7850	1972,71	CLA-03
38	F5	2C	1	450	225	15	9,7	9,7	0,0259069	0,2513	7850	1972,71	CLA-03
39	G5	2C	1	450	225	15	9,7	9,7	0,0259069	0,2513	7850	1972,71	CLA-03
40	H5	2C	1	450	225	15	9,7	9,7	0,0259069	0,2513	7850	1972,71	CLA-03
41	I5	2C	1	450	225	15	9,7	9,7	0,0259069	0,2513	7850	1972,71	CLA-03
42	D6	2C	1	450	225	15	9,7	9,7	0,0259069	0,2513	7850	1972,71	CLA-03
43	E6	2C	1	450	225	15	9,7	9,7	0,0259069	0,2513	7850	1972,71	CLA-03
44	F6	2C	1	450	225	15	9,7	9,7	0,0259069	0,2513	7850	1972,71	CLA-03
45	G6	2C	1	450	225	15	9,7	9,7	0,0259069	0,2513	7850	1972,71	CLA-03
46	H6	2C	1	450	225	15	9,7	9,7	0,0259069	0,2513	7850	1972,71	CLA-03
47	I6	2C	1	450	225	15	9,7	9,7	0,0259069	0,2513	7850	1972,71	CLA-03
48	D7	2C	1	450	225	15	9,7	9,7	0,0259069	0,2513	7850	1972,71	CLA-03
49	E7	2C	1	450	225	15	9,7	9,7	0,0259069	0,2513	7850	1972,71	CLA-03
50	F7	2C	1	450	225	15	9,7	9,7	0,0259069	0,2513	7850	1972,71	CLA-03
51	G7	2C	1	450	225	15	9,7	9,7	0,0259069	0,2513	7850	1972,71	CLA-03
52	H8	2C	1	450	225	15	9,7	9,7	0,0259069	0,2513	7850	1972,71	CLA-03
53	I6	2C	1	450	225	15	9,7	9,7	0,0259069	0,2513	7850	1972,71	CLA-03
54	B3'	2C	1	400	400	15	4,29	4,29	0,0185004	0,0794	7850	623,29	CLA-03
											SUMATORIA	90085,27	

CONTRATISTA

FISCALIZACIÓN

GOBIERNO AUTÓNOMO DESCENTRALIZADO DE LA PROVINCIA DEL PASTAZA

PROYECTO " CONSTRUCCIÓN DE LOS HANGARES DEL GOBIERNO AUTÓNOMO DESCENTRALIZADO PROVINCIAL DE PASTAZA (GADPPz) I ETAPA, PARROQUIA FÁTIMA, CANTÓN Y PROVINCIA DE PLANILLA DE AVANCE DE OBRA N° 23

RUBRO N° 120 ANEXO 2
 DESCRPCION: TRATAMIENTO PINTURA ESTRUCTURA ACERO A36
 UNIDAD: Kg
 PERIODO: 01-jul 31-jul



PAG. 2 DE 9

PLANILLA DE ELEMENTOS PARA PLANTA ADMINISTRATIVA (COLUMNAS)

ACERO LAMINADO EN FRIO PARA COLUMNAS ; ASTM A572 GRADO 50

COLUM	EJES	TIPO	N°	DIMENSIONES (mm)			LONGITUD (m)		SECCION - RADIO CURVATURA(m2)	VOLUMEN (m3)	DENSIDAD A572 (kg/m3)	PESO TOTAL (kg)	DESCRIPCIÓN
				H	B	e	PARCIAL	TOTAL					
1	A1	2C	1	450	225	15	9,7	9,7	0,0259069	0,2513	7850	1972,71	CLA-03
2	B1	2C	1	450	225	12	9,7	9,7	0,0209004	0,2027	7850	1591,20	CLA-01
3	C1	2C	1	450	225	12	9,7	9,7	0,0209004	0,2027	7850	1591,20	CLA-01
4	D1	2C	1	450	225	12	9,7	9,7	0,0209004	0,2027	7850	1591,20	CLA-01
5	E1	2C	1	450	225	12	9,7	9,7	0,0209004	0,2027	7850	1591,20	CLA-01
6	F1	2C	1	450	225	12	9,7	9,7	0,0209004	0,2027	7850	1591,20	CLA-01
7	G1	2C	1	450	225	15	9,7	9,7	0,0259069	0,2513	7850	1972,71	CLA-03
8	H1	2C	1	450	225	12	4,9	4,9	0,0209004	0,1024	7850	803,84	CLA-02
9	A2	2C	1	450	225	12	9,7	9,7	0,0209004	0,2027	7850	1591,20	CLA-01
10	B2	2C	1	450	225	15	4,9	4,9	0,0259069	0,1269	7850	996,17	CLA-04
11	C2	2C	1	450	225	15	9,7	9,7	0,0259069	0,2513	7850	1972,71	CLA-03
12	D2	2C	1	450	225	15	9,7	9,7	0,0259069	0,2513	7850	1972,71	CLA-03
13	E2	2C	1	450	225	15	9,7	9,7	0,0259069	0,2513	7850	1972,71	CLA-03
14	F2	2C	1	450	225	15	9,7	9,7	0,0259069	0,2513	7850	1972,71	CLA-03
15	G2	2C	1	450	225	12	9,7	9,7	0,0209004	0,2027	7850	1591,20	CLA-01
16	H2	2C	1	450	225	12	4,9	4,9	0,0209004	0,1024	7850	803,84	CLA-02
17	I2	2C	1	450	225	15	4,9	4,9	0,0259069	0,1269	7850	996,17	CLA-04
18	A3	2C	1	450	225	12	9,7	9,7	0,0209004	0,2027	7850	1591,20	CLA-01
19	B3	2C	1	450	225	15	4,9	4,9	0,0259069	0,1269	7850	996,17	CLA-04
20	C3	2C	1	450	225	15	9,7	9,7	0,0259069	0,2513	7850	1972,71	CLA-03
21	D3	2C	1	450	225	15	9,7	9,7	0,0259069	0,2513	7850	1972,71	CLA-03
22	E3	2C	1	450	225	15	9,7	9,7	0,0259069	0,2513	7850	1972,71	CLA-03
23	F3	2C	1	450	225	15	9,7	9,7	0,0259069	0,2513	7850	1972,71	CLA-03
24	G3	2C	1	450	225	12	9,7	9,7	0,0209004	0,2027	7850	1591,20	CLA-01
25	H3	2C	1	450	225	12	4,9	4,9	0,0209004	0,1024	7850	803,84	CLA-02
26	I3	2C	1	450	225	12	4,9	4,9	0,0209004	0,1024	7850	803,84	CLA-02
27	A4	2C	1	450	225	15	9,7	9,7	0,0259069	0,2513	7850	1972,71	CLA-03
28	B4	2C	1	450	225	12	9,7	9,7	0,0209004	0,2027	7850	1591,20	CLA-01
29	C4	2C	1	450	225	12	9,7	9,7	0,0209004	0,2027	7850	1591,20	CLA-01
30	D4	2C	1	450	225	12	9,7	9,7	0,0209004	0,2027	7850	1591,20	CLA-01
31	E4	2C	1	450	225	12	9,7	9,7	0,0209004	0,2027	7850	1591,20	CLA-01
32	F4	2C	1	450	225	12	9,7	9,7	0,0209004	0,2027	7850	1591,20	CLA-01
33	G4	2C	1	450	225	15	9,7	9,7	0,0259069	0,2513	7850	1972,71	CLA-03
34	H4	2C	1	450	225	12	4,9	4,9	0,0209004	0,1024	7850	803,84	CLA-02
35	I4	2C	1	450	225	15	4,9	4,9	0,0259069	0,1269	7850	996,17	CLA-04
36	D5	2C	1	450	225	15	9,7	9,7	0,0259069	0,2513	7850	1972,71	CLA-03
37	E5	2C	1	450	225	15	9,7	9,7	0,0259069	0,2513	7850	1972,71	CLA-03
38	F5	2C	1	450	225	15	9,7	9,7	0,0259069	0,2513	7850	1972,71	CLA-03
39	G5	2C	1	450	225	15	9,7	9,7	0,0259069	0,2513	7850	1972,71	CLA-03
40	H5	2C	1	450	225	15	9,7	9,7	0,0259069	0,2513	7850	1972,71	CLA-03
41	I5	2C	1	450	225	15	9,7	9,7	0,0259069	0,2513	7850	1972,71	CLA-03
42	D6	2C	1	450	225	15	9,7	9,7	0,0259069	0,2513	7850	1972,71	CLA-03
43	E6	2C	1	450	225	15	9,7	9,7	0,0259069	0,2513	7850	1972,71	CLA-03
44	F6	2C	1	450	225	15	9,7	9,7	0,0259069	0,2513	7850	1972,71	CLA-03
45	G6	2C	1	450	225	15	9,7	9,7	0,0259069	0,2513	7850	1972,71	CLA-03
46	H6	2C	1	450	225	15	9,7	9,7	0,0259069	0,2513	7850	1972,71	CLA-03
47	I6	2C	1	450	225	15	9,7	9,7	0,0259069	0,2513	7850	1972,71	CLA-03
48	D7	2C	1	450	225	15	9,7	9,7	0,0259069	0,2513	7850	1972,71	CLA-03
49	E7	2C	1	450	225	15	9,7	9,7	0,0259069	0,2513	7850	1972,71	CLA-03
50	F7	2C	1	450	225	15	9,7	9,7	0,0259069	0,2513	7850	1972,71	CLA-03
51	G7	2C	1	450	225	15	9,7	9,7	0,0259069	0,2513	7850	1972,71	CLA-03
52	H8	2C	1	450	225	15	9,7	9,7	0,0259069	0,2513	7850	1972,71	CLA-03
53	I6	2C	1	450	225	15	9,7	9,7	0,0259069	0,2513	7850	1972,71	CLA-03
54	B3	2C	1	400	400	15	4,29	4,29	0,0185004	0,0794	7850	623,29	CLA-03
											SUMATORIA	90085,27	

 CONTRATISTA

 FISCALIZACIÓN

GOBIERNO AUTONOMO DESCENTRALIZADO DE LA PROVINCIA DEL PASTAZA

PROYECTO " CONSTRUCCIÓN DE LOS HANGARES DEL GOBIERNO AUTÓNOMO DESCENTRALIZADO PROVINCIAL DE PASTAZA (GADPPz) I ETAPA, PARROQUIA FÁTIMA, CANTÓN Y PROVINCIA DE PASTAZA "

PLANILLA DE AVANCE DE OBRA N°12

RUBRO N° 120 ANEXO 3
 DESCRPCION: TRATAMIENTO PINTURA ESTRUCTURA ACERO A36 (FONDO+PINTURA ANTICORROSIVA), A COMPRESOR
 UNIDAD: Kg
 PERIODO: 01-jul 31-jul



PAG. 3 DE 9

PLANILLA DE ELEMENTOS PARA PLANTA ADMINISTRATIVA (VIGAS N+5,09)
 ACERO LAMINADO EN FRIO PARA COLUMNAS; ASTM A572 GRADO 50 (VIGAS N+5,09)

RESUMEN DE MATERIALES

EJE HORZ	EJE VERT	MARCA	PERFIL	CANTIDAD	MATERIAL	LONGITUD (mm)	PESO kg/m	PESO TOTAL (kg)	PESO TOTAL (kg)
VIGA PRINCIPALES (HORIZONTALES)									
1_2	A	1VM2-01	IPE 360	1	A572-GR 50	4,89	57,1	279,22	2025,37
1_2	B	1VM2-02	IPE 360	1	A572-GR 50	4,89	57,1	279,22	
1_2	C	1VM2-02	IPE 360	1	A572-GR 50	4,89	57,1	279,22	
1_2	D	1VM2-02	IPE 360	1	A572-GR 50	4,89	57,1	279,22	
1_2	E	1VM2-02	IPE 360	1	A572-GR 50	4,89	57,1	279,22	
1_2	F	1VM2-02	IPE 360	1	A572-GR 50	4,89	57,1	279,22	
1_2	G	1VM2-02	IPE 360	1	A572-GR 50	4,89	57,1	279,22	
1_2	H	1VM4-10	IPE 270	1	A572-GR 50	2,14	33,1	70,83	
2_3	A	1VM2-03	IPE 360	1	A572-GR 50	5,11	57,1	291,78	2626,02
2_3	B	1VM2-04	IPE 360	1	A572-GR 50	5,11	57,1	291,78	
2_3	C	1VM2-04	IPE 360	1	A572-GR 50	5,11	57,1	291,78	
2_3	D	1VM2-04	IPE 360	1	A572-GR 50	5,11	57,1	291,78	
2_3	E	1VM2-04	IPE 360	1	A572-GR 50	5,11	57,1	291,78	
2_3	F	1VM2-04	IPE 360	1	A572-GR 50	5,11	57,1	291,78	
2_3	G	1VM2-04	IPE 360	1	A572-GR 50	5,11	57,1	291,78	
2_3	H	1VM2-04	IPE 360	1	A572-GR 50	5,11	57,1	291,78	
2_3	I	1VM2-04	IPE 360	1	A572-GR 50	5,11	57,1	291,78	
3_4	A	1VM2-06	IPE 360	1	A572-GR 50	5,06	57,1	288,93	2600,37
3_4	B	1VM2-06	IPE 360	1	A572-GR 50	5,06	57,1	288,93	
3_4	C	1VM2-05	IPE 360	1	A572-GR 50	5,06	57,1	288,93	
3_4	D	1VM2-07	IPE 360	1	A572-GR 50	5,06	57,1	288,93	
3_4	E	1VM2-08	IPE 360	1	A572-GR 50	5,06	57,1	288,93	
3_4	F	1VM2-05	IPE 360	1	A572-GR 50	5,06	57,1	288,93	
3_4	G	1VM2-05	IPE 360	1	A572-GR 50	5,06	57,1	288,93	
3_4	H	1VM2-05	IPE 360	1	A572-GR 50	5,06	57,1	288,93	
3_4	I	1VM2-05	IPE 360	1	A572-GR 50	5,06	57,1	288,93	
5_6	D	1VM1-03	IPE 450	1	A572-GR 50	9,73	77,6	755,05	4530,3
5_6	E	1VM1-02	IPE 450	1	A572-GR 50	9,73	77,6	755,05	
5_6	F	1VM1-02	IPE 450	1	A572-GR 50	9,73	77,6	755,05	
5_6	G	1VM1-02	IPE 450	1	A572-GR 50	9,73	77,6	755,05	
5_6	H	1VM1-02	IPE 450	1	A572-GR 50	9,73	77,6	755,05	
5_6	I	1VM1-05	IPE 450	1	A572-GR 50	9,73	77,6	755,05	
6_7	D	1VM1-04	IPE 450	1	A572-GR 50	9,60	77,6	744,96	4469,76
6_7	E	1VM1-01	IPE 450	1	A572-GR 50	9,60	77,6	744,96	
6_7	F	1VM1-01	IPE 450	1	A572-GR 50	9,60	77,6	744,96	
6_7	G	1VM1-01	IPE 450	1	A572-GR 50	9,60	77,6	744,96	
6_7	H	1VM1-01	IPE 450	1	A572-GR 50	9,60	77,6	744,96	
6_7	I	1VM1-06	IPE 450	1	A572-GR 50	9,60	77,6	744,96	
SUMATORIA								16251,82	

CONTRATISTA

FISCALIZACION

GOBIERNO AUTONOMO DESCENTRALIZADO DE LA PROVINCIA DEL PASTAZA

PROYECTO " CONSTRUCCIÓN DE LOS HANGARES DEL GOBIERNO AUTÓNOMO DESCENTRALIZADO PROVINCIAL DE PASTAZA (GADPPZ) I ETAPA, PARROQUIA FÁTIMA, CANTÓN Y PROVINCIA DE PASTAZA "

PLANILLA DE AVANCE DE OBRA N°12

RUBRO N° 120 ANEXO 4
 DESCRPCION: TRATAMIENTO PINTURA ESTRUCTURA ACERO A36 (FONDO+PINTURA ANTICORROSIVA), A COMPRESOR
 UNIDAD: Kg
 PERIODO: 01-jul 31-jul



PAG. 4 DE 9

PLANILLA DE ELEMENTOS PARA PLANTA ADMINISTRATIVA (VIGAS N+5,09)
 ACERO LAMINADO EN FRIO PARA COLUMNAS; ASTM A572 GRADO 50 (VIGAS N+5,09)

RESUMEN DE MATERIALES

EJE HORZ	EJE VERT	MARCA	PERFIL	CANTIDAD	MATERIAL	LONGITUD (mm)	PESO kg/m	PESO TOTAL (kg)	PESO TOTAL (kg)
VIGA PRINCIPALES (VERTICALES)									
A-B	1	1VM4-04	IPE 270	1	A572-GR 50	4,92	36,1	177,61	710,44
A-B	2	1VM4-04	IPE 270	1	A572-GR 50	4,92	36,1	177,61	
A-B	3	1VM4-04	IPE 270	1	A572-GR 50	4,92	36,1	177,61	
A-B	4	1VM4-04	IPE 270	1	A572-GR 50	4,92	36,1	177,61	
B-C	1	1VM4-01	IPE 270	1	A572-GR 50	4,94	36,1	178,33	713,32
B-C	2	1VM4-01	IPE 270	1	A572-GR 50	4,94	36,1	178,33	
B-C	3	1VM4-01	IPE 270	1	A572-GR 50	4,94	36,1	178,33	
B-C	4	1VM4-01	IPE 270	1	A572-GR 50	4,94	36,1	178,33	
C-D	1	1VM4-01	IPE 270	1	A572-GR 50	4,94	36,1	178,33	713,32
C-D	2	1VM4-01	IPE 270	1	A572-GR 50	4,94	36,1	178,33	
C-D	3	1VM4-01	IPE 270	1	A572-GR 50	4,94	36,1	178,33	
C-D	4	1VM4-01	IPE 270	1	A572-GR 50	4,94	36,1	178,33	
D-E	1	1VM4-01	IPE 270	1	A572-GR 50	4,94	36,1	178,33	1248,31
D-E	2	1VM4-01	IPE 270	1	A572-GR 50	4,94	36,1	178,33	
D-E	3	1VM4-01	IPE 270	1	A572-GR 50	4,94	36,1	178,33	
D-E	4	1VM4-05	IPE 270	1	A572-GR 50	4,94	36,1	178,33	
D-E	5	1VM4-01	IPE 270	1	A572-GR 50	4,94	36,1	178,33	
D-E	6	1VM4-01	IPE 270	1	A572-GR 50	4,94	36,1	178,33	
D-E	7	1VM4-01	IPE 270	1	A572-GR 50	4,94	36,1	178,33	
E-F	1	1VM4-01	IPE 270	1	A572-GR 50	4,94	36,1	178,33	1248,31
E-F	2	1VM4-01	IPE 270	1	A572-GR 50	4,94	36,1	178,33	
E-F	3	1VM4-01	IPE 270	1	A572-GR 50	4,94	36,1	178,33	
E-F	4	1VM4-01	IPE 270	1	A572-GR 50	4,94	36,1	178,33	
E-F	5	1VM4-01	IPE 270	1	A572-GR 50	4,94	36,1	178,33	
E-F	6	1VM4-01	IPE 270	1	A572-GR 50	4,94	36,1	178,33	
E-F	7	1VM4-01	IPE 270	1	A572-GR 50	4,94	36,1	178,33	
F-G	1	1VM4-06	IPE 270	1	A572-GR 50	4,97	36,1	179,42	1255,94
F-G	2	1VM4-06	IPE 270	1	A572-GR 50	4,97	36,1	179,42	
F-G	3	1VM4-06	IPE 270	1	A572-GR 50	4,97	36,1	179,42	
F-G	4	1VM4-06	IPE 270	1	A572-GR 50	4,97	36,1	179,42	
F-G	5	1VM4-06	IPE 270	1	A572-GR 50	4,97	36,1	179,42	
F-G	6	1VM4-06	IPE 270	1	A572-GR 50	4,97	36,1	179,42	
F-G	7	1VM4-06	IPE 270	1	A572-GR 50	4,97	36,1	179,42	
G-H	1	1VM3-08	IPE 300	1	A572-GR 50	6,05	42,2	255,31	1325,29
G-H	2	1VM4-01	IPE 270	1	A572-GR 50	4,94	36,1	178,33	
G-H	3	1VM4-01	IPE 270	1	A572-GR 50	4,94	36,1	178,33	
G-H	4	1VM4-01	IPE 270	1	A572-GR 50	4,94	36,1	178,33	
G-H	5	1VM4-01	IPE 270	1	A572-GR 50	4,94	36,1	178,33	
G-H	6	1VM4-01	IPE 270	1	A572-GR 50	4,94	36,1	178,33	
G-H	7	1VM4-01	IPE 270	1	A572-GR 50	4,94	36,1	178,33	
H-I	1	1VM3-09	IPE 300	1	A572-GR 50	5,94	42,2	250,67	1312,01
H-I	2	1VM4-02	IPE 270	1	A572-GR 50	4,90	36,1	176,89	
H-I	3	1VM4-02	IPE 270	1	A572-GR 50	4,90	36,1	176,89	
H-I	4	1VM4-02	IPE 270	1	A572-GR 50	4,90	36,1	176,89	
H-I	5	1VM4-02	IPE 270	1	A572-GR 50	4,90	36,1	176,89	
H-I	6	1VM4-02	IPE 270	1	A572-GR 50	4,90	36,1	176,89	
H-I	7	1VM4-02	IPE 270	1	A572-GR 50	4,90	36,1	176,89	
SUMATORIA								8526,94	

CONTRATISTA

FISCALIZACION

GOBIERNO AUTONOMO DESCENTRALIZADO DE LA PROVINCIA DEL PASTAZA

PROYECTO " CONSTRUCCIÓN DE LOS HANGARES DEL GOBIERNO AUTÓNOMO DESCENTRALIZADO PROVINCIAL DE PASTAZA (GADPPz) I ETAPA, PARROQUIA FÁTIMA, CANTÓN Y PROVINCIA DE PASTAZA "

PLANILLA DE AVANCE DE OBRA N°12

RUBRO N° 120 ANEXO 5
 DESCRPCION: TRATAMIENTO PINTURA ESTRUCTURA ACERO A36 (FONDO+PINTURA ANTICORROSIVA), A COMPRESOR
 UNIDAD: Kg
 PERIODO: 01-jul 31-jul



PAG. 5 DE 9

PLANILLA DE ELEMENTOS PARA PLANTA ADMINISTRATIVA (VIGAS N+5,09)
 ACERO LAMINADO EN FRIO PARA COLUMNAS; ASTM A572 GRADO 50 (VIGAS N+5,09)

RESUMEN DE MATERIALES									
EJE HORZ	EJE VERT	MARCA	PERFIL	CANTIDAD	MATERIAL	LONGITUD (mm)	PESO kg/m	PESO TOTAL (kg)	PESO TOTAL (kg)
VIGA SECUNDARIAS (VERTICALES)									
A-B	1_2	1VS4-04	IPE 240	2	A572-GR 50	5,50	30,7	337,7	1013,1
A-B	2_3	1VS4-04	IPE 240	2	A572-GR 50	5,50	30,7	337,7	
A-B	3_4	1VS4-04	IPE 240	2	A572-GR 50	5,50	30,7	337,7	
B-C	1_2	1VS1-02	IPE 240	2	A572-GR 50	5,37	30,7	329,72	989,16
B-C	2_3	1VS1-02	IPE 240	2	A572-GR 50	5,37	30,7	329,72	
B-C	3_4	1VS1-02	IPE 240	2	A572-GR 50	5,37	30,7	329,72	
C-D	1_2	1VS1-02	IPE 240	2	A572-GR 50	5,37	30,7	329,72	989,16
C-D	2_3	1VS1-02	IPE 240	2	A572-GR 50	5,37	30,7	329,72	
C-D	3_4	1VS1-02	IPE 240	2	A572-GR 50	5,37	30,7	329,72	
D-E	1_2	1VS1-02	IPE 240	2	A572-GR 50	5,37	30,7	329,72	2347,94
D-E	2_3	1VS1-02	IPE 240	2	A572-GR 50	5,37	30,7	329,72	
D-E	5_6	1VS1-03	IPE 240	5	A572-GR 50	5,5	30,7	844,25	
D-E	6_7	1VS1-03	IPE 240	5	A572-GR 50	5,5	30,7	844,25	
E-F	1_2	1VS1-02	IPE 240	2	A572-GR 50	5,37	30,7	329,72	2637,76
E-F	2_3	1VS1-02	IPE 240	2	A572-GR 50	5,37	30,7	329,72	
E-F	3_4	1VS1-02	IPE 240	2	A572-GR 50	5,37	30,7	329,72	
E-F	5_6	1VS1-01	IPE 240	5	A572-GR 50	5,37	30,7	824,3	
E-F	6_7	1VS1-01	IPE 240	5	A572-GR 50	5,37	30,7	824,3	
F-G	1_2	1VS1-05	IPE 240	2	A572-GR 50	5,4	30,7	331,56	2652,48
F-G	2_3	1VS1-05	IPE 240	2	A572-GR 50	5,4	30,7	331,56	
F-G	3_4	1VS1-05	IPE 240	2	A572-GR 50	5,4	30,7	331,56	
F-G	5_6	1VS1-20	IPE 240	5	A572-GR 50	5,4	30,7	828,9	
F-G	6_7	1VS1-20	IPE 240	5	A572-GR 50	5,4	30,7	828,9	
G-H	1_2	1VS1-08	IPE 240	1	A572-GR 50	3,87	30,7	118,81	2591,71
G-H	1_2	1VS1-13	IPE 240	1	A572-GR 51	5,37	30,7	164,86	
G-H	2_3	1VS1-02	IPE 240	2	A572-GR 50	5,37	30,7	329,72	
G-H	3_4	1VS1-02	IPE 240	2	A572-GR 50	5,37	30,7	329,72	
G-H	5_6	1VS1-10	IPE 240	5	A572-GR 50	5,37	30,7	824,3	
G-H	6_7	1VS1-11	IPE 240	5	A572-GR 50	5,37	30,7	824,3	
H-I	1_2	1VS1-09	IPE 240	1	A572-GR 50	2,17	30,7	66,62	2393,08
H-I	2_3	1VS1-06	IPE 240	2	A572-GR 50	5,32	30,7	326,65	
H-I	3_4	1VS1-06	IPE 240	2	A572-GR 50	5,32	30,7	326,65	
H-I	5_6	1VS1-23	IPE 240	5	A572-GR 50	5,45	30,7	836,58	
H-I	6_7	1VS1-23	IPE 240	5	A572-GR 50	5,45	30,7	836,58	
SUMATORIA								15614,39	

CONTRATISTA

FISCALIZACION

PROYECTO " CONSTRUCCIÓN DE LOS HANGARES DEL GOBIERNO AUTÓNOMO DESCENTRALIZADO PROVINCIAL DE PASTAZA (GADPPz) I ETAPA, PARROQUIA FÁTIMA, CANTÓN Y PROVINCIA DE PASTAZA "

RUBRO N° 120 ANEXO 6
 DESCRPCION: TRATAMIENTO PINTURA ESTRUCTURA ACERO A36 (FONDO+PINTURA ANTICORROSIVA), A COMPRESOR
 UNIDAD: Kg
 PERIODO: 01-jul 31-jul



PLANILLA DE ELEMENTOS PARA PLANTA ADMINISTRATIVA (VIGAS N+5,09)
 ACERO LAMINADO EN FRIO PARA COLUMNAS; ASTM A572 GRADO 50 (VIGAS N+5,09)

VOLADO DE ESCALERA N+5,09

EJES HOR	EJES VERT	TIPO	N°	DIMENSIONES (mm)			LONGITUD (m)		AREA	VOLUMEN (m³)	DENSIDAD A572 (kg/m³)	PESO TOTAL (kg)	DESCRIPCIÓN
				H	B	#	PARCIAL	TOTAL					
D-E	3_4	O	1	0,1	0,1	3	3,06	3,06	0,0012	0,0110	7850	28,83	ESCALERA

EJE HORZ	EJE VERT	MARCA	PERFIL	CANTIDAD	MATERIAL	LONGITUD (mm)	PESO kg/m	PESO TOTAL (kg)	PESO TOTAL (kg)
----------	----------	-------	--------	----------	----------	---------------	-----------	-----------------	-----------------

VIGA SECUNDARIAS ESCALERA

D-E	3_4	VS1	IPE 240	1	A572-GR 50	3,70	30,7	113,59	367,79
		VS2	IPE 240	1	A572-GR 50	4,40	30,7	135,08	
		VS3	IPE 240	2	A572-GR 50	0,54	30,7	33,16	
		VS4	IPE 240	2	A572-GR 51	1,40	30,7	85,96	

VOLADO DE N+5,09

VIGA SECUNDARIAS VOLADO

G-H-I	1_2	1VM4-10	IPE 270	3	A572-GR 50	1,00	36,1	108,3	519,68
		1VS1-17	IPE 240	1	A572-GR 50	13,40	30,7	411,38	

I	1_4	1VS1-17	IPE 240	1	A572-GR 50	0,57	30,7	17,5	598,28
		1VM4-07	IPE 270	2	A572-GR 50	1,00	36,1	72,2	
		1VS1-01	IPE 240	4	A572-GR 50	1,10	30,7	135,08	
		1VM4-09	IPE 270	1	A572-GR 50	1,00	36,1	36,1	
		1VS1-15	IPE 240	1	A572-GR 50	5,44	30,7	167,01	
		1VS1-14	IPE 240	1	A572-GR 50	5,55	30,7	170,39	

SUMATORIA 1514,58

CONTRATISTA

FISCALIZACION

PROYECTO

" CONSTRUCCIÓN DE LOS HANGARES DEL GOBIERNO AUTÓNOMO DESCENTRALIZADO PROVINCIAL DE PASTAZA (GADPPZ) I ETAPA, PARROQUIA FÁTIMA, CANTÓN Y PROVINCIA DE PASTAZA "

PLANILLA DE AVANCE DE OBRA N°13

RUBRO N° 120 ANEXO 7
 DESCRPCION: TRATAMIENTO PINTURA ESTRUCTURA ACERO A36 (FONDO+PINTURA ANTICORROSIVA), A COMPRESOR
 UNIDAD: Kg
 PERIODO: 01-mar 17-mar



PLANILLA DE ELEMENTOS PARA PLANTA ADMINISTRATIVA (VIGAS N+9,88)
 ACERO LAMINADO EN FRIO PARA COLUMNAS; ASTM A572 GRADO 50 (VIGAS N+9,88)

RESUMEN DE MATERIALES

EJE HORZ	EJE VERT	MARCA	PERFIL	CANTIDAD	MATERIAL	LONGITUD (mm)	PESO kg/m	PESO TOTAL (kg)	PESO TOTAL (kg)
VIGA PRINCIPALES (HORIZONTALES)									
1,2	A	2VM3-03	IPE-300	1	A572-GR 50	4,89	42,2	206,36	1633,92
1,2	B	2VM1-08	IPE-450	1	A572-GR 50	5,10	77,6	395,76	
1,2	C	2VM3-03	IPE-300	1	A572-GR 50	4,89	42,2	206,36	
1,2	D	2VM3-03	IPE-300	1	A572-GR 50	4,89	42,2	206,36	
1,2	E	2VM3-03	IPE-300	1	A572-GR 50	4,89	42,2	206,36	
1,2	F	2VM3-03	IPE-300	1	A572-GR 50	4,89	42,2	206,36	
1,2	G	2VM3-03	IPE-300	1	A572-GR 50	4,89	42,2	206,36	
2,3	A	2VM3-02	IPE-300	1	A572-GR 50	5,11	42,2	215,64	1726,07
2,3	B	2VM1-09	IPE-450	1	A572-GR 50	5,57	77,6	432,23	
2,3	C	2VM3-02	IPE-300	1	A572-GR 50	5,11	42,2	215,64	
2,3	D	2VM3-02	IPE-300	1	A572-GR 50	5,11	42,2	215,64	
2,3	E	2VM3-02	IPE-300	1	A572-GR 50	5,11	42,2	215,64	
2,3	F	2VM3-02	IPE-300	1	A572-GR 50	5,11	42,2	215,64	
2,3	G	2VM3-02	IPE-300	1	A572-GR 50	5,11	42,2	215,64	
3,4	A	2VM3-01	IPE-300	1	A572-GR 50	5,06	42,2	213,53	2155,11
3,4	B	2VM1-10	IPE-450	1	A572-GR 50	5,28	77,6	409,73	
3,4	C	2VM3-01	IPE-300	1	A572-GR 50	5,26	42,2	221,97	
3,4	D	2VM3-01	IPE-300	1	A572-GR 50	6,26	42,2	264,17	
3,4	E	2VM3-01	IPE-300	1	A572-GR 50	7,26	42,2	306,37	
3,4	F	2VM3-01	IPE-300	1	A572-GR 50	8,26	42,2	348,57	
3,4	G	2VM3-01	IPE-300	1	A572-GR 50	9,26	42,2	390,77	
5,6	D	2VM1-01	IPE-450	1	A572-GR 50	9,73	77,6	755,05	4530,3
5,6	E	2VM1-05	IPE-450	1	A572-GR 50	9,73	77,6	755,05	
5,6	F	2VM1-05	IPE-450	1	A572-GR 50	9,73	77,6	755,05	
5,6	G	2VM1-05	IPE-450	1	A572-GR 50	9,73	77,6	755,05	
5,6	H	2VM1-11	IPE-450	1	A572-GR 50	9,73	77,6	755,05	
5,6	I	2VM1-03	IPE-450	1	A572-GR 50	9,73	77,6	755,05	
6,7	D	2VM1-02	IPE-450	1	A572-GR 50	9,60	77,6	744,96	4469,76
6,7	E	2VM1-06	IPE-450	1	A572-GR 50	9,60	77,6	744,96	
6,7	F	2VM1-06	IPE-450	1	A572-GR 50	9,60	77,6	744,96	
6,7	G	2VM1-06	IPE-450	1	A572-GR 50	9,60	77,6	744,96	
6,7	H	2VM1-12	IPE-450	1	A572-GR 50	9,60	77,6	744,96	
6,7	I	2VM1-07	IPE-450	1	A572-GR 50	9,60	77,6	744,96	
SUMATORIA								14515,16	

CONTRATISTA

FISCALIZACION

GOBIERNO AUTONOMO DESCENTRALIZADO DE LA PROVINCIA DEL PASTAZA

PROYECTO

" CONSTRUCCIÓN DE LOS HANGARES DEL GOBIERNO AUTÓNOMO DESCENTRALIZADO PROVINCIAL DE PASTAZA (GADPPz) I ETAPA, PARROQUIA FÁTIMA, CANTÓN Y PROVINCIA DE PASTAZA "

PLANILLA DE AVANCE DE OBRA N°13

RUBRO N° 120 ANEXO 8
 DESCRPCION: TRATAMIENTO PINTURA ESTRUCTURA ACERO A36 (FONDO+PINTURA ANTICORROSIVA), A COMPRESOR
 UNIDAD: Kg
 PERIODO: 01-mar 17-mar



PAG. 8 DE 9

PLANILLA DE ELEMENTOS PARA PLANTA ADMINISTRATIVA (VIGAS N+9,88)
 ACERO LAMINADO EN FRIO PARA COLUMNAS; ASTM A572 GRADO 50 (VIGAS N+9,88)

RESUMEN DE MATERIALES

EJE HORZ	EJE VERT	MARCA	PERFIL	CANTIDAD	MATERIAL	LONGITUD (mm)	PESO kg/m	PESO TOTAL (kg)	PESO TOTAL (kg)
VIGA PRINCIPALES (VERTICALES)									
A-B	1	2VM4-02	IPE-270	1	A572-GR 50	4,91	36,1	177,25	1954,62
A-B-C	2	2VM1-04	IPE-450	1	A572-GR 50	10,31	77,6	800,06	
A-B-C	3	2VM1-04	IPE-450	1	A572-GR 50	10,31	77,6	800,06	
A-B	4	2VM4-02	IPE-270	1	A572-GR 50	4,91	36,1	177,25	
B-C	1	2VM4-01	IPE-270	1	A572-GR 50	4,94	36,1	178,33	356,66
B-C	2	2VM4-01	IPE-270	1	A572-GR 50	4,94	36,1	178,33	
C-D	1	2VM4-01	IPE-270	1	A572-GR 50	4,94	36,1	178,33	713,32
C-D	2	2VM4-01	IPE-270	1	A572-GR 50	4,94	36,1	178,33	
C-D	3	2VM4-01	IPE-270	1	A572-GR 50	4,94	36,1	178,33	
C-D	4	2VM4-01	IPE-270	1	A572-GR 50	4,94	36,1	178,33	
D-E	1	2VM4-01	IPE-270	1	A572-GR 50	4,94	36,1	178,33	1248,31
D-E	2	2VM4-01	IPE-270	1	A572-GR 50	4,94	36,1	178,33	
D-E	3	2VM4-01	IPE-270	1	A572-GR 50	4,94	36,1	178,33	
D-E	4	2VM4-01	IPE-270	1	A572-GR 50	4,94	36,1	178,33	
D-E	5	2VM4-01	IPE-270	1	A572-GR 50	4,94	36,1	178,33	
D-E	6	2VM4-01	IPE-270	1	A572-GR 50	4,94	36,1	178,33	
D-E	7	2VM4-01	IPE-270	1	A572-GR 50	4,94	36,1	178,33	
E-F	1	2VM4-01	IPE-270	1	A572-GR 50	4,94	36,1	178,33	1248,31
E-F	2	2VM4-01	IPE-270	1	A572-GR 50	4,94	36,1	178,33	
E-F	3	2VM4-01	IPE-270	1	A572-GR 50	4,94	36,1	178,33	
E-F	4	2VM4-01	IPE-270	1	A572-GR 50	4,94	36,1	178,33	
E-F	5	2VM4-01	IPE-270	1	A572-GR 50	4,94	36,1	178,33	
E-F	6	2VM4-01	IPE-270	1	A572-GR 50	4,94	36,1	178,33	
E-F	7	2VM4-01	IPE-270	1	A572-GR 50	4,94	36,1	178,33	
F-G	1	2VM4-03	IPE-270	1	A572-GR 50	4,96	36,1	179,06	1253,42
F-G	2	2VM4-03	IPE-270	1	A572-GR 50	4,96	36,1	179,06	
F-G	3	2VM4-03	IPE-270	1	A572-GR 50	4,96	36,1	179,06	
F-G	4	2VM4-03	IPE-270	1	A572-GR 50	4,96	36,1	179,06	
F-G	5	2VM4-03	IPE-270	1	A572-GR 50	4,96	36,1	179,06	
F-G	6	2VM4-03	IPE-270	1	A572-GR 50	4,96	36,1	179,06	
F-G	7	2VM4-03	IPE-270	1	A572-GR 50	4,96	36,1	179,06	
G-H	5	2VM4-09	IPE-270	1	A572-GR 50	4,94	36,1	178,33	534,99
G-H	6	2VM4-01	IPE-270	1	A572-GR 50	4,94	36,1	178,33	
G-H	7	2VM4-01	IPE-270	1	A572-GR 50	4,94	36,1	178,33	
H-I	5	2VM4-10	IPE-270	1	A572-GR 50	4,94	36,1	178,33	534,99
H-I	6	2VM4-06	IPE-270	1	A572-GR 50	4,94	36,1	178,33	
H-I	7	2VM4-06	IPE-270	1	A572-GR 50	4,94	36,1	178,33	

SUMATORIA 7844,62

CONTRATISTA

FISCALIZACION

" CONSTRUCCIÓN DE LOS HANGARES DEL GOBIERNO AUTÓNOMO DESCENTRALIZADO PROVINCIAL DE PASTAZA
(GADPPz) I ETAPA, PARROQUIA FÁTIMA, CANTÓN Y PROVINCIA DE PASTAZA "

PROYECTO:

RUBRO	120
DESCRIPCION	TRATAMIENTO PINTURA ESTRUCTURA ACERO A36 (FONDO+PINTURA ANTICORROSIVA), A COMPRESOR
UNIDAD	Kg
PERIODO	1 DE JUNIO 2021 A 30 DE JUNIO 2021



ANEXO: 1

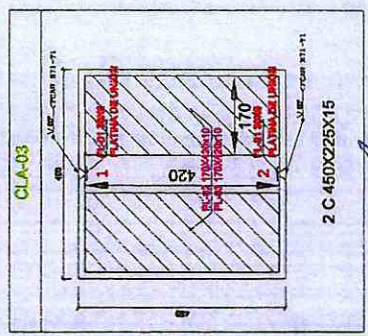
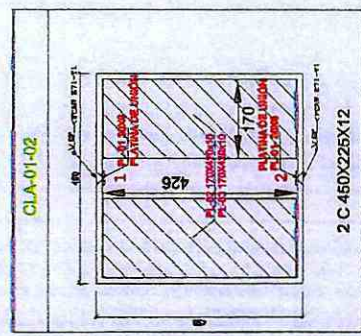
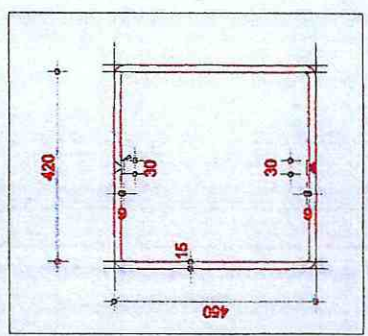
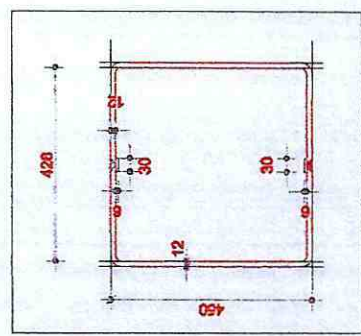
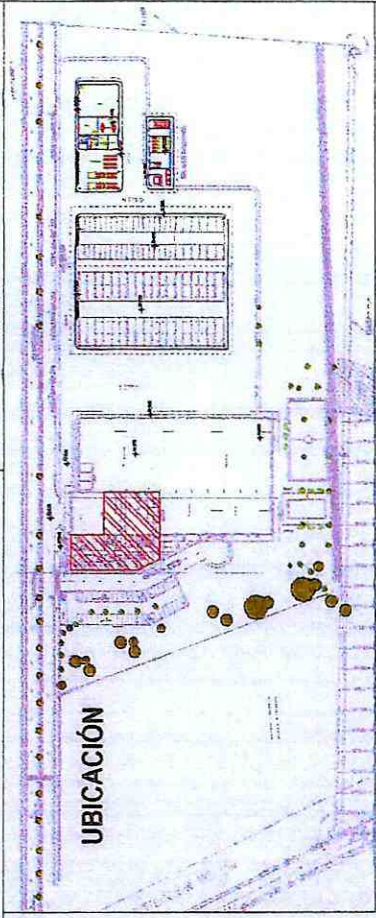
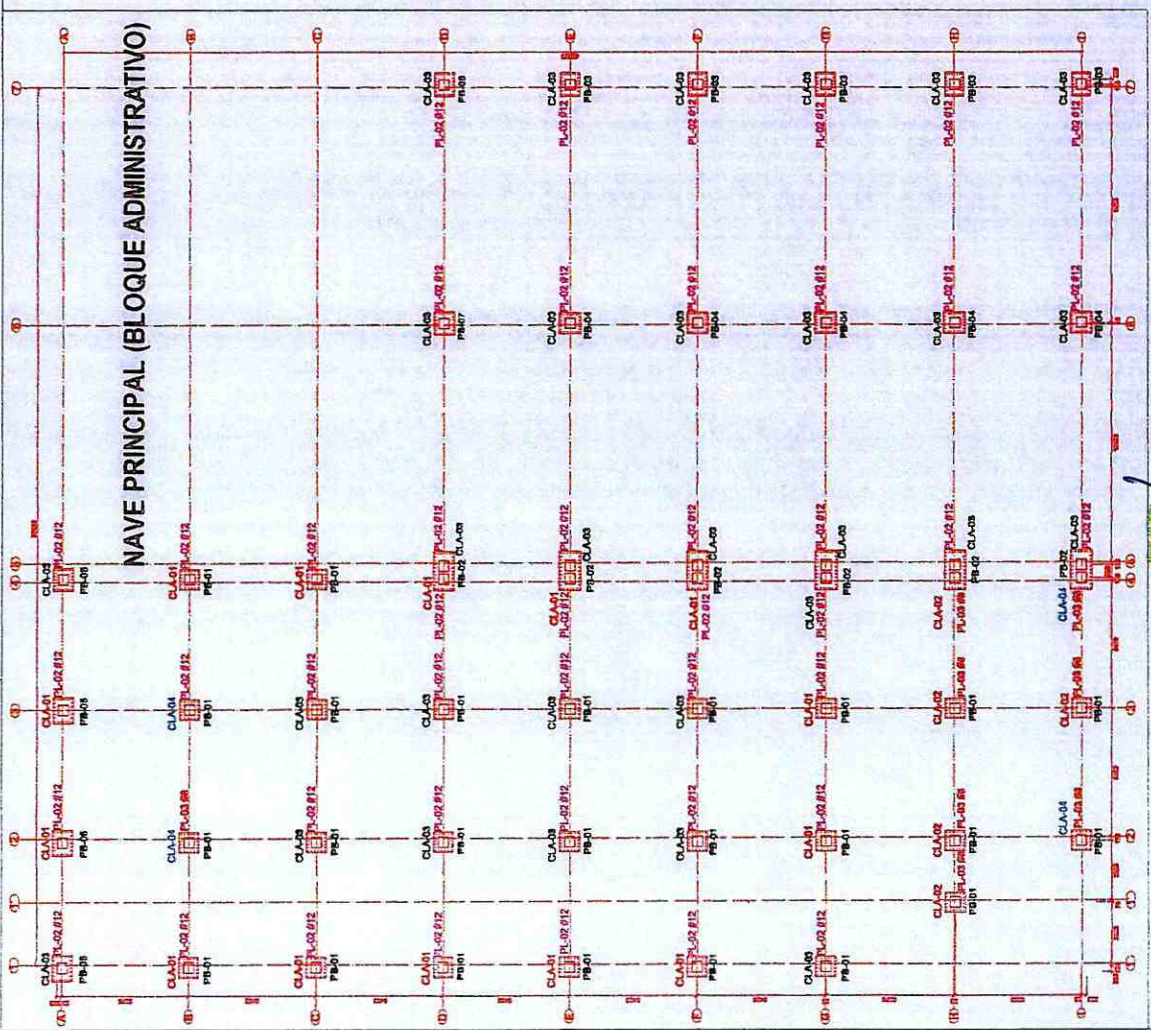

CONTRATISTA

FISCALIZACIÓN

" CONSTRUCCIÓN DE LOS HANGARES DEL GOBIERNO AUTÓNOMO DESCENTRALIZADO PROVINCIAL DE PASTAZA
(GADPPP) I ETAPA, PARROQUIA FÁTIMA, CANTÓN Y PROVINCIA DE PASTAZA "

RUBRO 120
DESCRIPCION TRATAMIENTO PINTURA ESTRUCTURA ACERO A36 (FONDO+PINTURA ANTICORROSIVA), A Compresor
UNIDAD Kg
PERIODO 1 DE JUNIO 2021 A 30 DE JUNIO 2021

ANEXO: 2

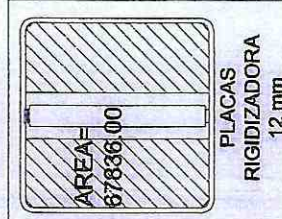
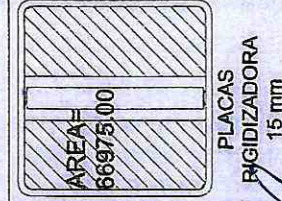
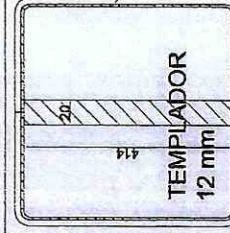
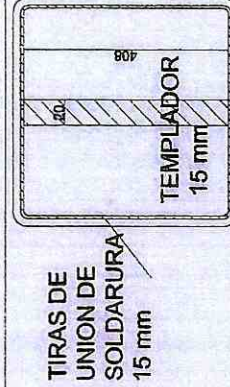
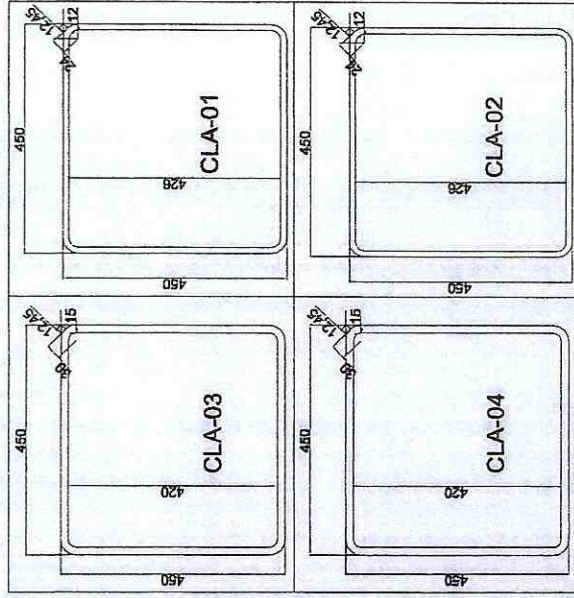
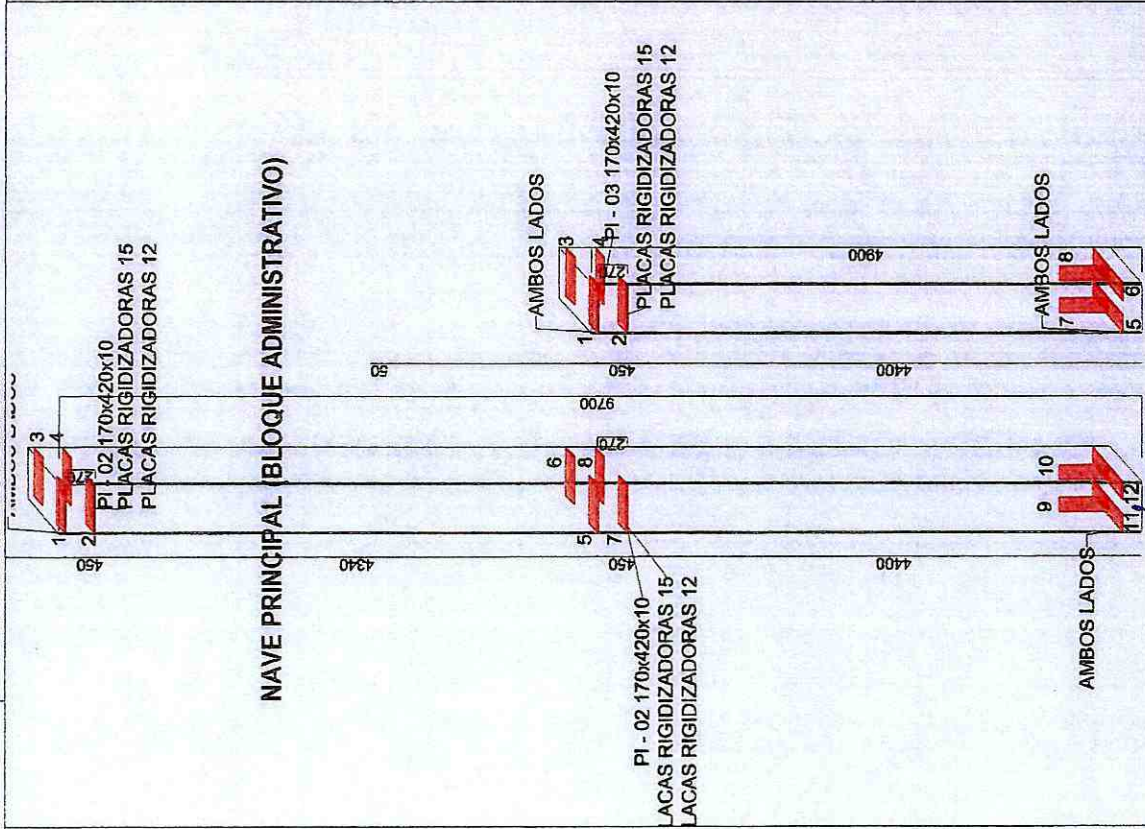

CONTRATISTA

FISCALIZACIÓN

" CONSTRUCCIÓN DE LOS HANGARES DEL GOBIERNO AUTÓNOMO DESCENTRALIZADO PROVINCIAL DE PASTAZA
(GADPPZ) I ETAPA, PARROQUIA FÁTIMA, CANTÓN Y PROVINCIA DE PASTAZA "

RUBRO 120

DESCRIPCIÓN TRATAMIENTO PINTURA ESTRUCTURA ACERO A36 (FONDO+PINTURA ANTICORROSIVA), A COMPRESOR

UNIDAD Kg

PERIODO 1 DE JUNIO 2021 A 30 DE JUNIO 2021

ANEXO: 3

NAVE PRINCIPAL (BLOQUE ADMINISTRATIVO)

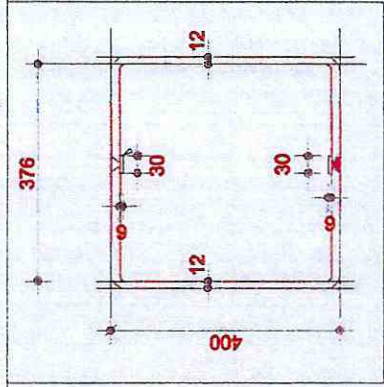
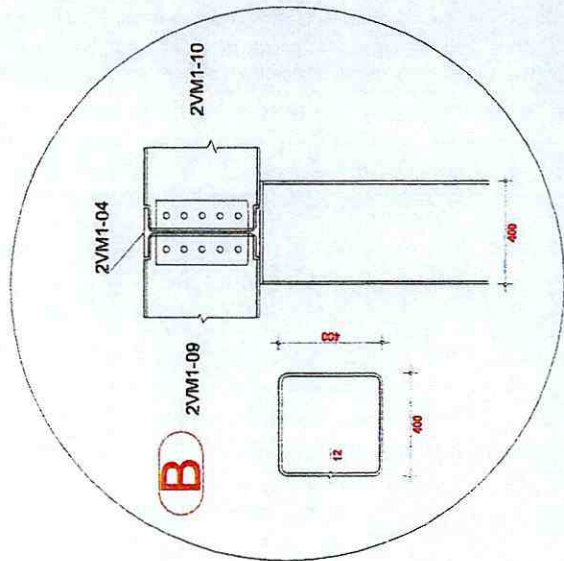
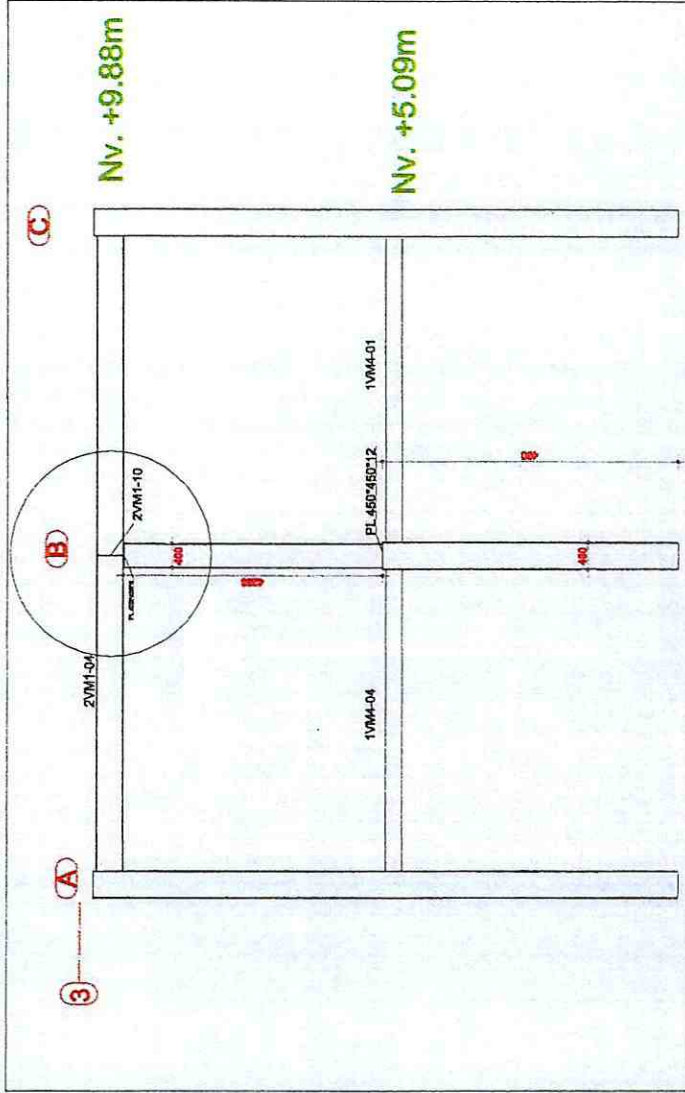
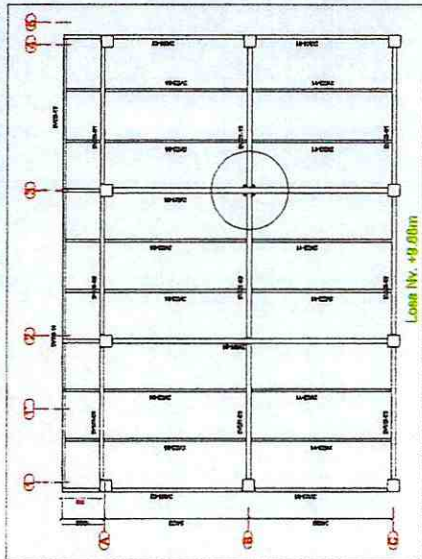

d

CONTRATISTA

[Signature]

FISCALIZACIÓN

" CONSTRUCCIÓN DE LOS HANGARES DEL GOBIERNO AUTÓNOMO DESCENTRALIZADO PROVINCIAL DE PASTAZA
(GADPP2) I ETAPA, PARROQUIA FÁTIMA, CANTÓN Y PROVINCIA DE PASTAZA "

PROYECTO:

RUBRO 120

DESCRIPCION

UNIDAD Kg

PERIODO

TRATAMIENTO PINTURA ESTRUCTURA ACERO A36 (FONDO+PINTURA ANTICORROSIVA), A COMPRESOR

ANEXO: 1

01 DE JUNIO 2021 A 30 DE JUNIO 2021

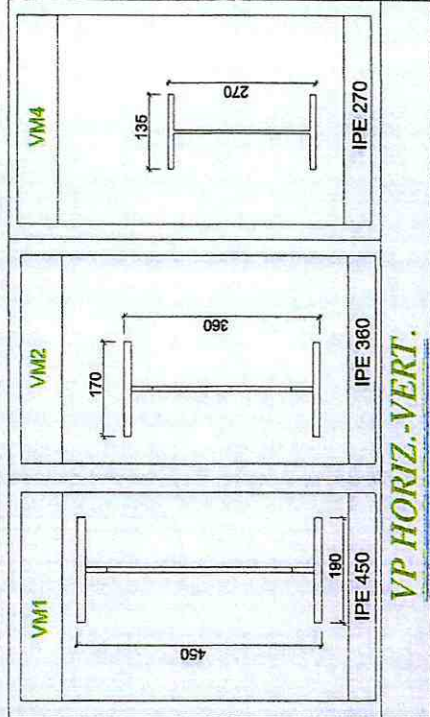
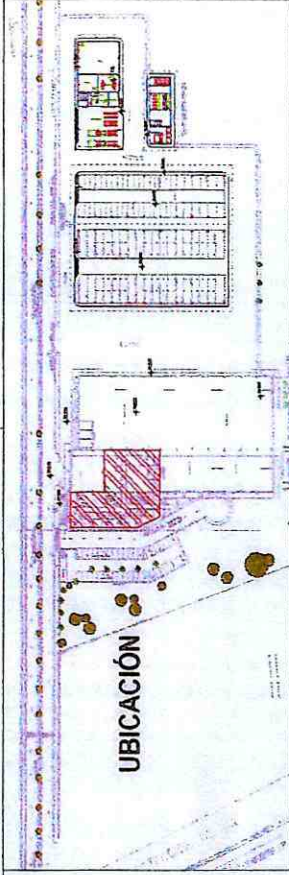
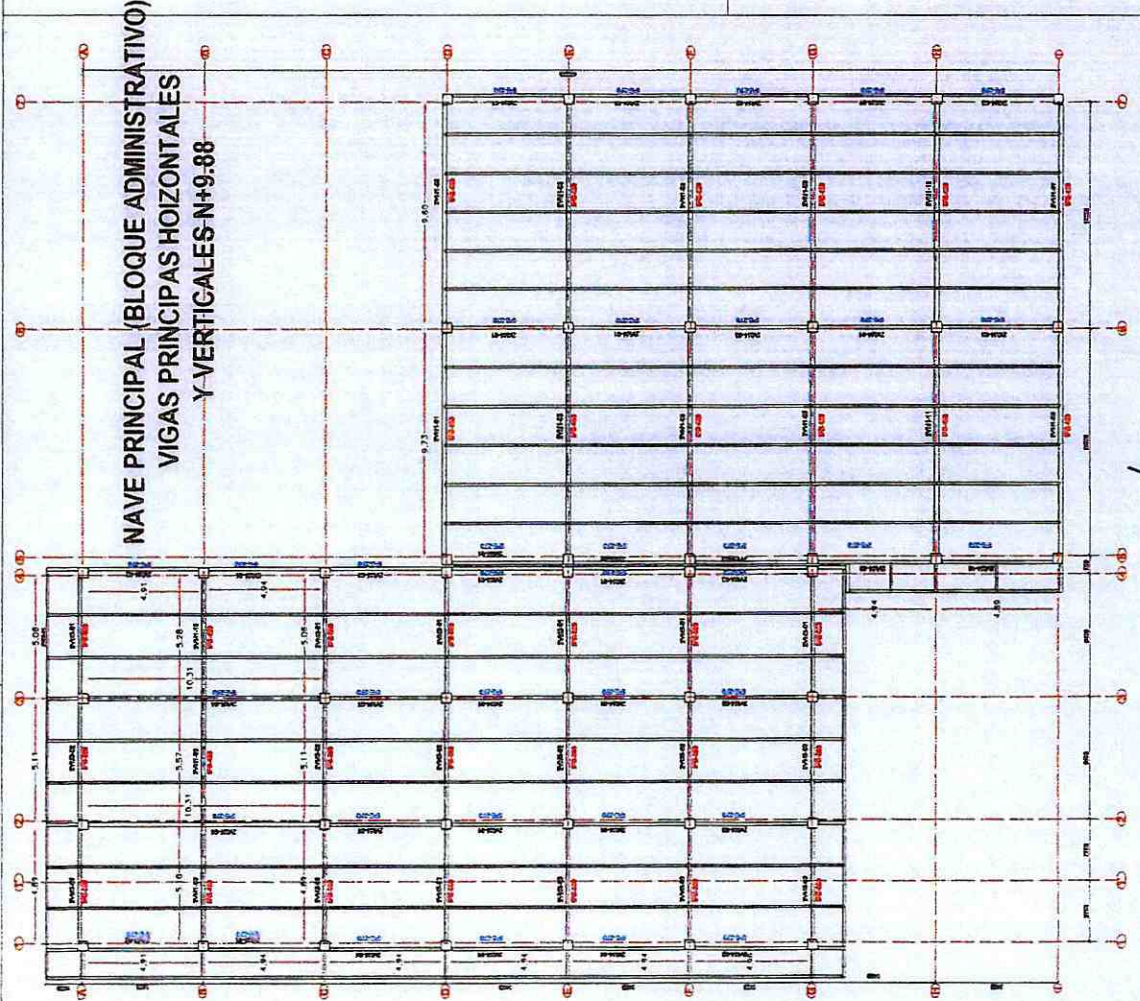

ISOMETRIA CONEXIONES

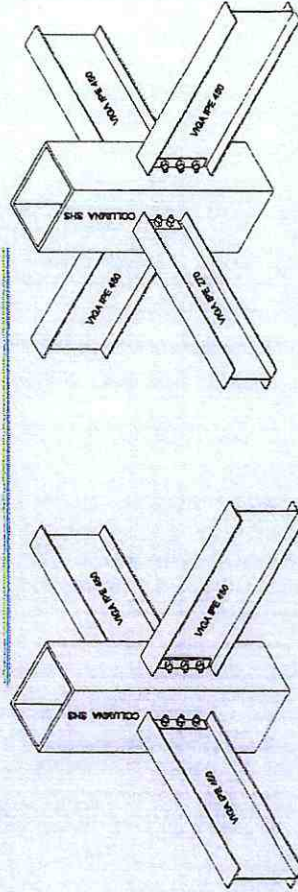

CONTRATISTA

FISCALIZACIÓN

" CONSTRUCCIÓN DE LOS HANGARES DEL GOBIERNO AUTÓNOMO DESCENTRALIZADO PROVINCIAL DE PASTAZA
(GADPPz) I ETAPA, PARROQUIA FÁTIMA, CANTÓN Y PROVINCIA DE PASTAZA "

PROYECTO:

RUBRO 120
DESCRIPCION TRATAMIENTO PINTURA ACERO A36 (FONDO+PINTURA ANTICORROSIVA), A COMPRESOR
UNIDAD Kg
PERIODO 01 DE JUNIO 2021 A 30 DE JUNIO 2021

ANEXO: 2

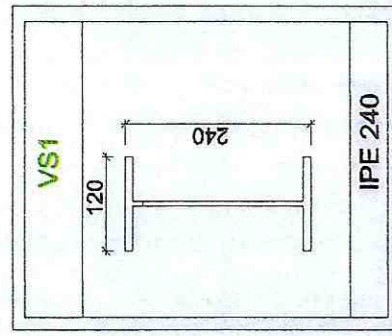
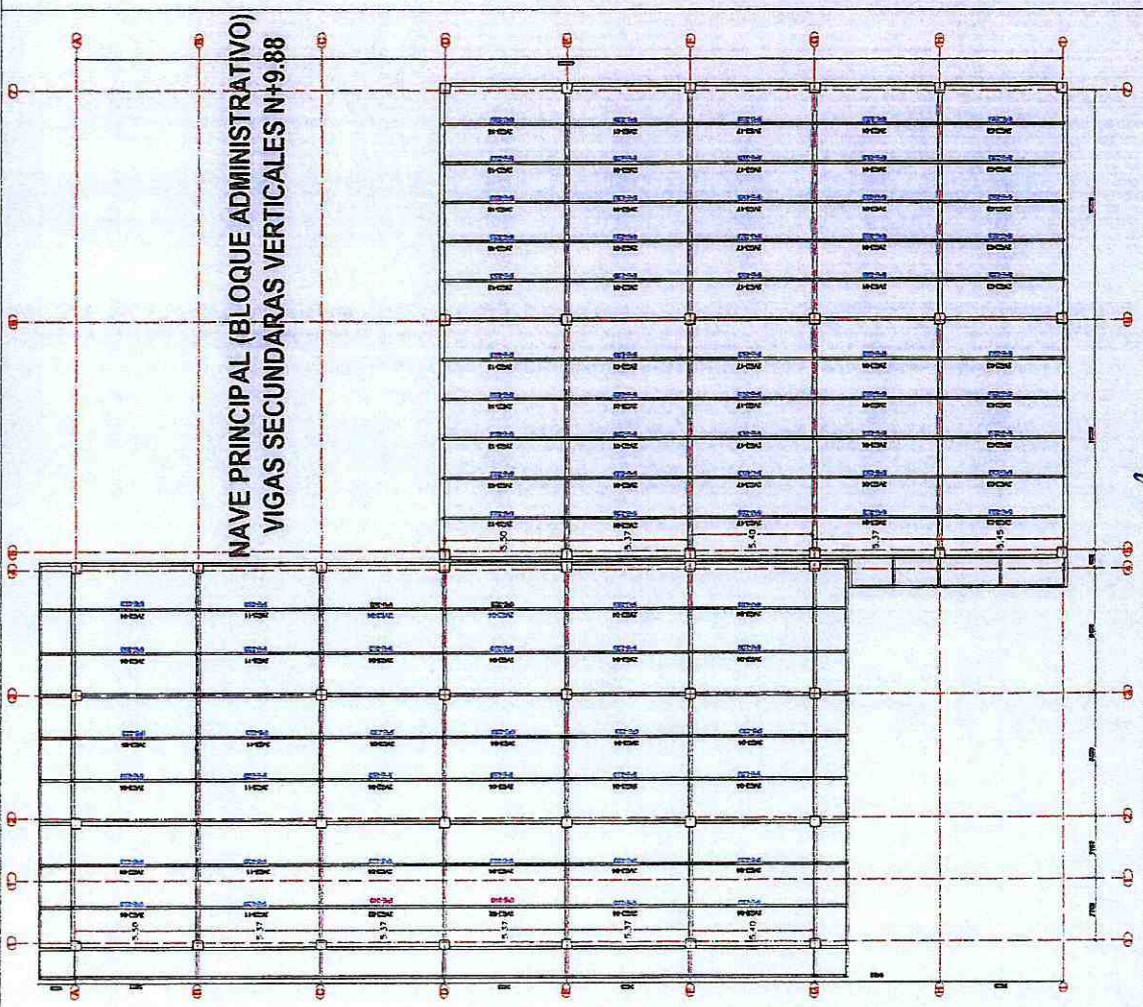

VS VERTICALES

ISOMETRIA CONEXIONES

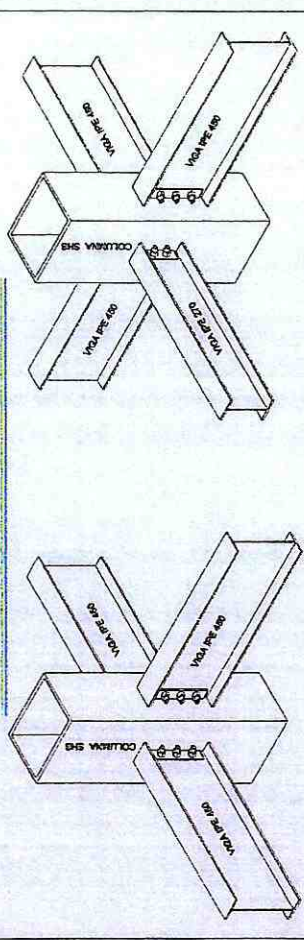

CONTRATISTA

FISCALIZACIÓN

" CONSTRUCCIÓN DE LOS HANGARES DEL GOBIERNO AUTÓNOMO DESCENTRALIZADO PROVINCIAL DE PASTAZA
(GADPPz) I ETAPA, PARROQUIA FÁTIMA, CANTÓN Y PROVINCIA DE PASTAZA "

PROYECTO:

RUBRO	120	ANEXO: 3
DESCRIPCION	TRATAMIENTO PINTURA ESTRUCTURA ACERO A36 (FONDO+PINTURA ANTICORROSIVA), A COMPRESOR	
UNIDAD	Kg	
PERIODO	01 DE JUNIO 2021 A 30 DE JUNIO 2021	

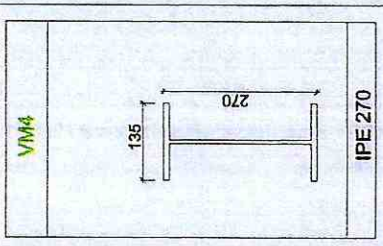
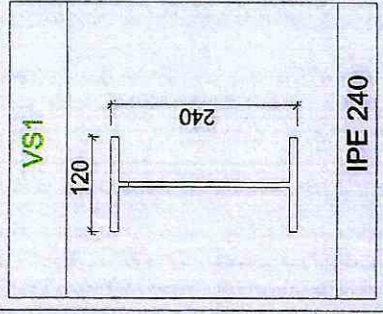
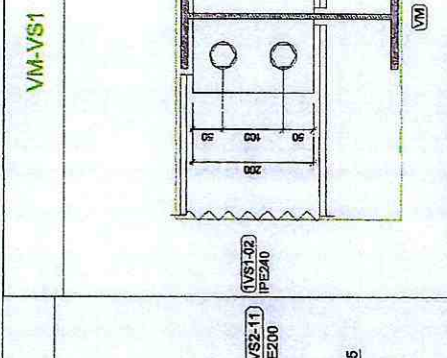
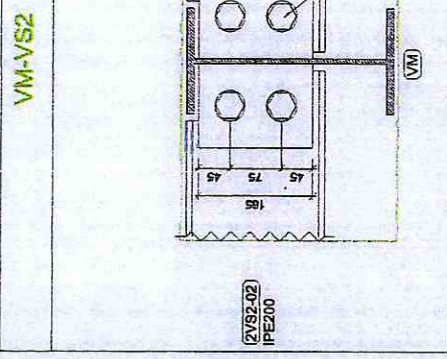
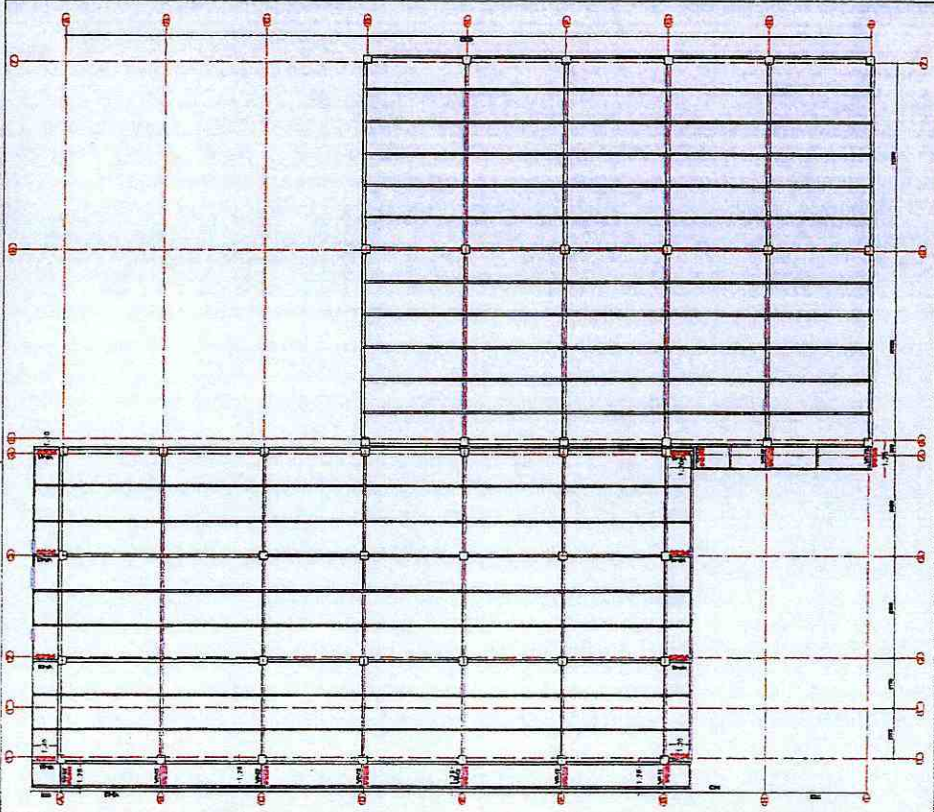

**NAVE PRINCIPAL (BLOQUE ADMINISTRATIVO)
VIGAS ESCALERA Y VOLADO N+9.88**

[Signature]
CONTRATISTA

[Signature]
FISCALIZACIÓN

" CONSTRUCCIÓN DE LOS HANGARES DEL GOBIERNO AUTÓNOMO DESCENTRALIZADO PROVINCIAL DE PASTAZA
(GADPPz) I ETAPA, PARROQUIA FÁTIMA, CANTÓN Y PROVINCIA DE PASTAZA "

PROYECTO:

RUBRO	120
DESCRIPCIÓN	TRATAMIENTO PINTURA ESTRUCTURA ACERO A36 (FONDO+PINTURA ANTICORROSIVA), A COMPRESOR
UNIDAD	Kg
PERIODO	1 DE JUNIO 2021 A 30 DE JUNIO 2021

ANEXO: 4

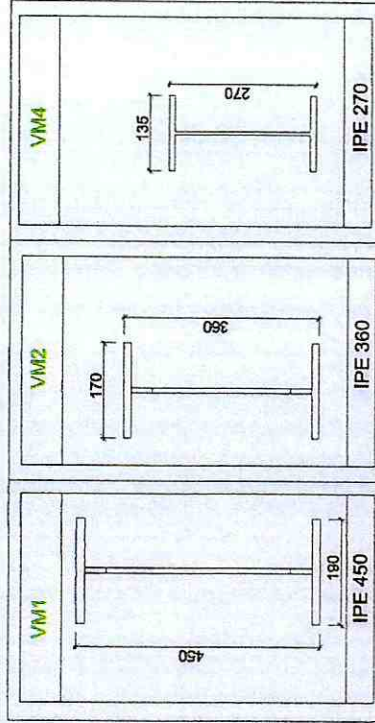
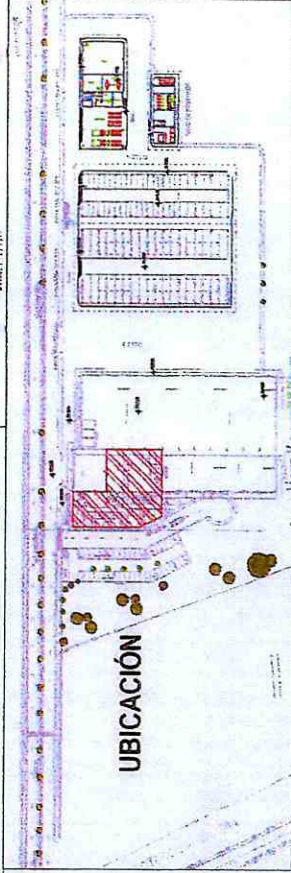
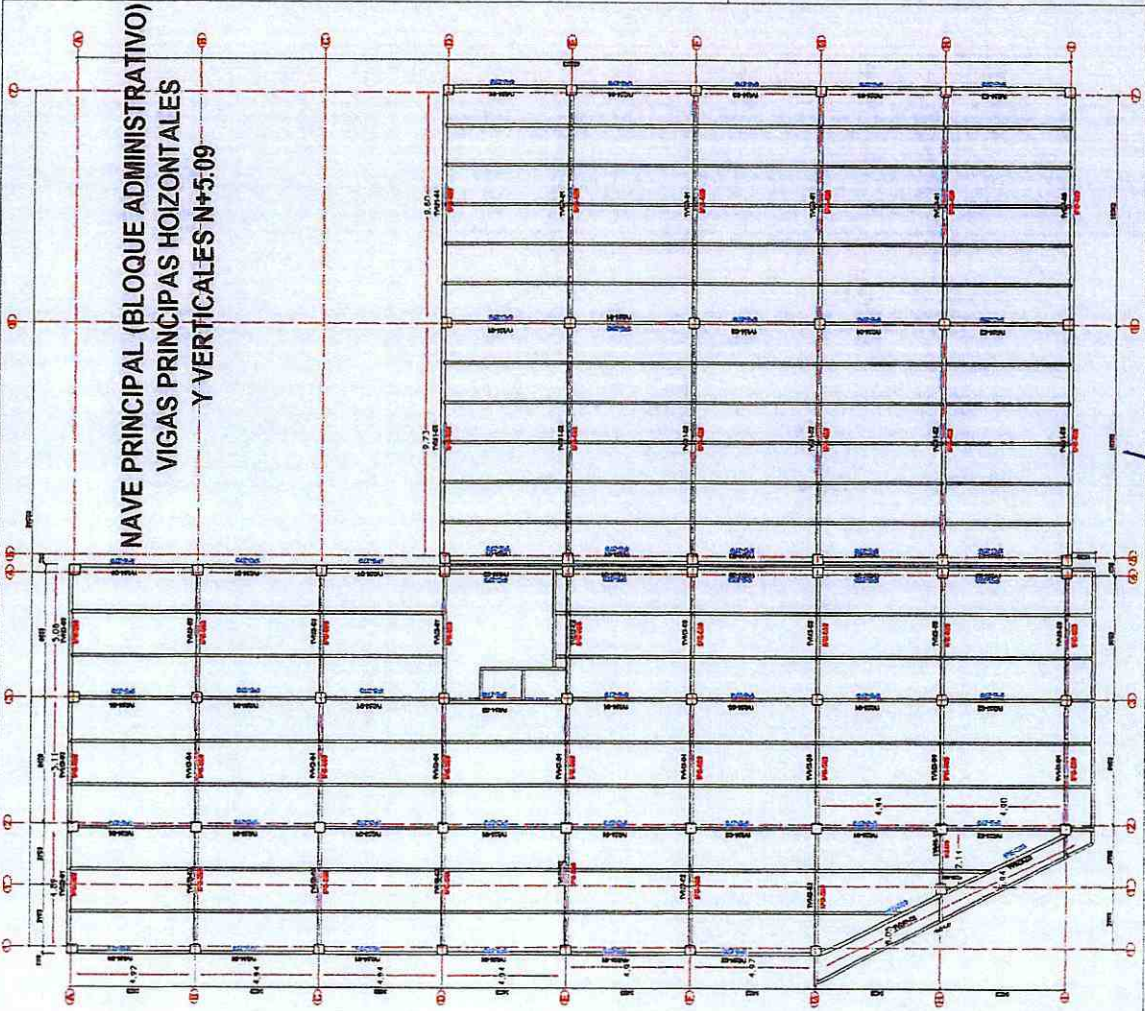

VP HORIZ.-VERT.

ISOMETRIA CONEXIONES

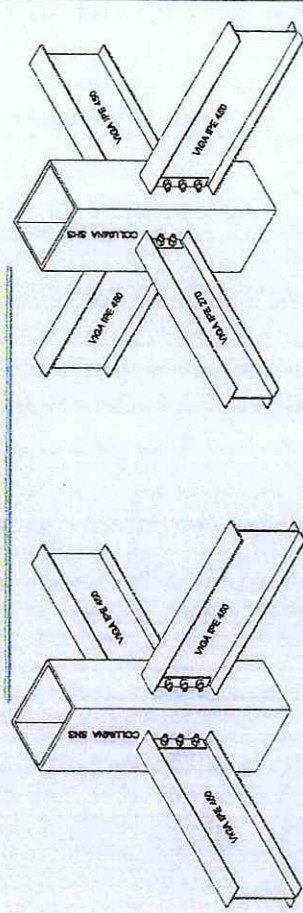

CONTRATISTA

REALIZACIÓN



PROYECTO:

RUBRO
DESCRIPCION
UNIDAD
PERIODO

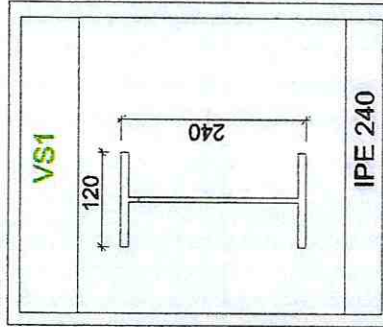
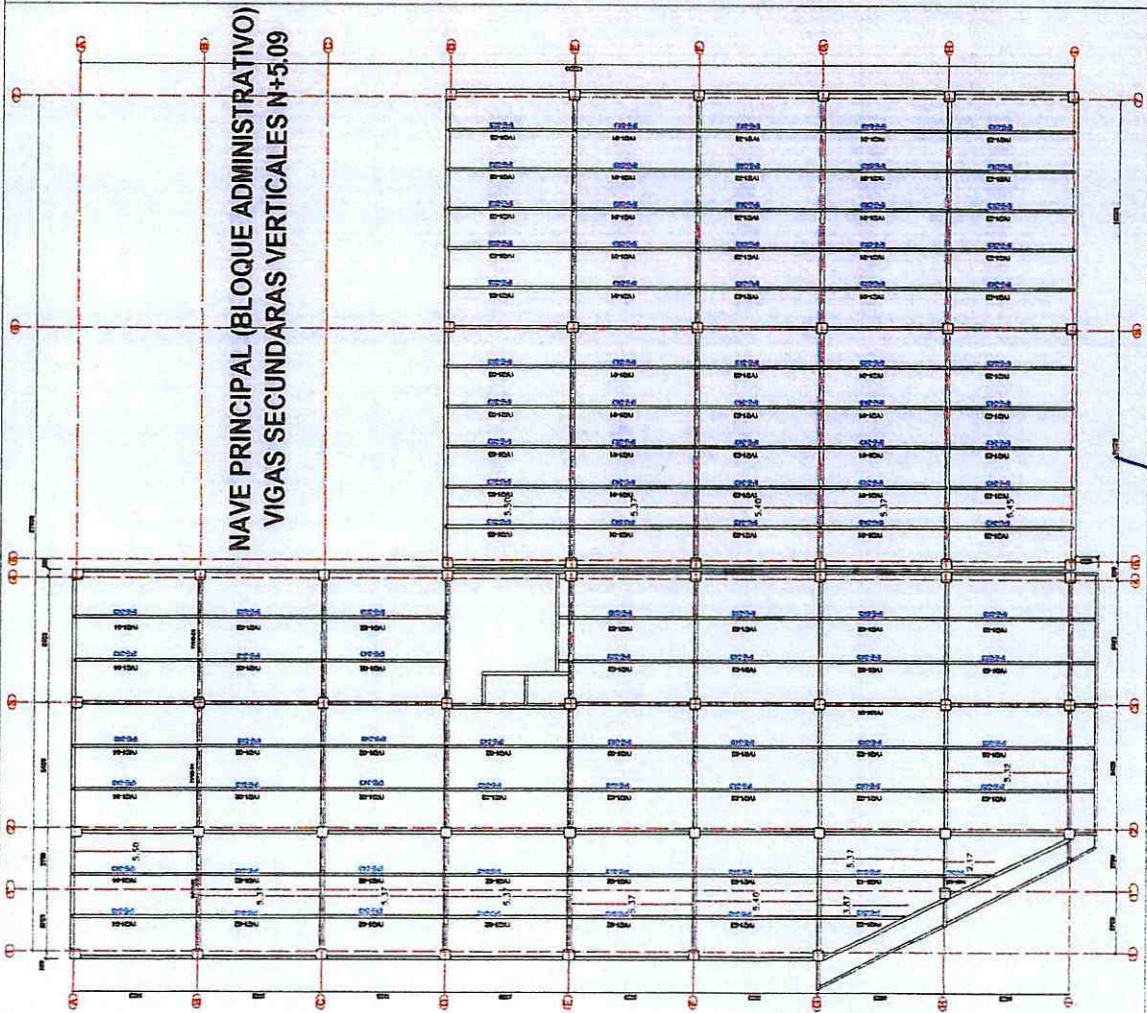

VS VERTICALES

ISOMETRIA CONEXIONES

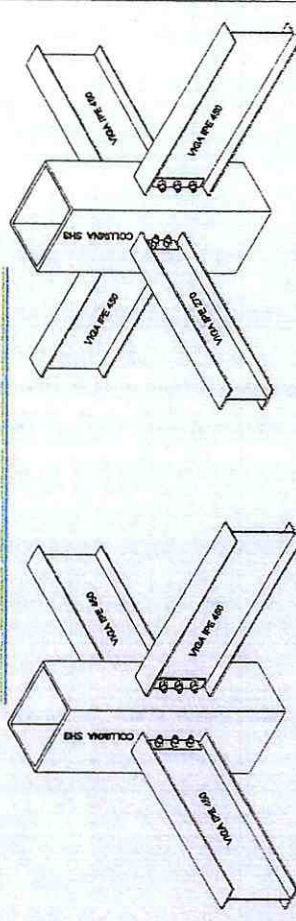

FISCALIZACIÓN

CONTRATISTA

**GOBIERNO AUTONOMO DESCENTRALIZADO DE LA
PROVINCIA DEL PASTAZA**

" CONSTRUCCIÓN DE LOS HANGARES DEL GOBIERNO AUTÓNOMO DESCENTRALIZADO PROVINCIAL DE PASTAZA
(GADPPZ) I ETAPA, PARROQUIA FÁTIMA, CANTÓN Y PROVINCIA DE PASTAZA "

PROYECTO:

RUBRO
DESCRIPCION
UNIDAD
PERIODO

ANEXO: 6

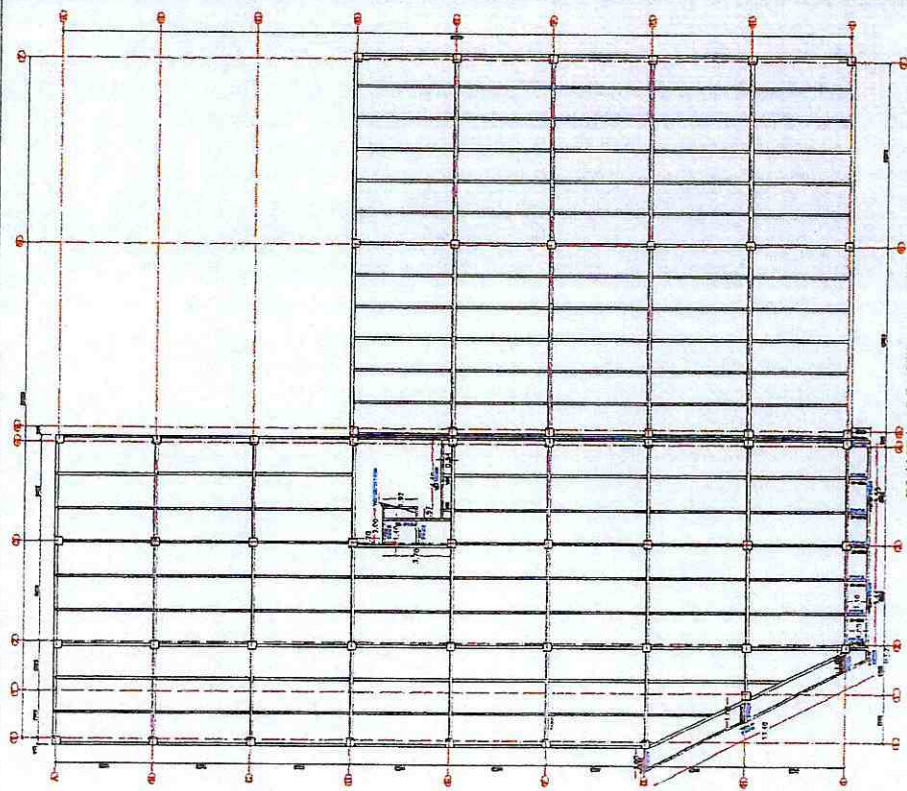

PLANTA LOSA NIVEL +5.09

**NAVE PRINCIPAL (BLOQUE ADMINISTRATIVO)
VIGAS ESCALERA Y VOLADO N+5.09**

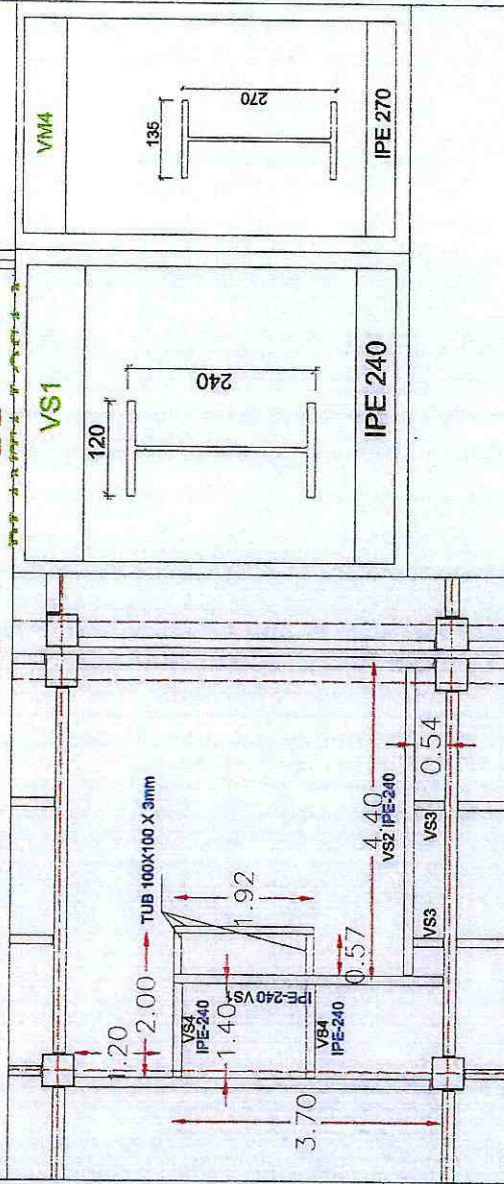
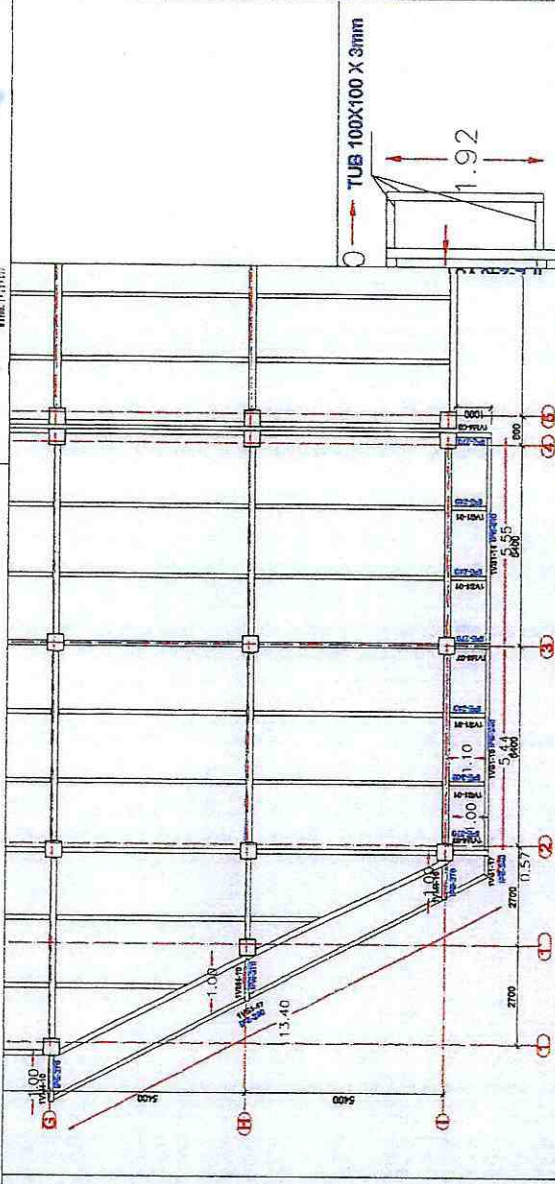

CONTRATISTA

FISCALIZACIÓN

GOBIERNO AUTÓNOMO DESCENTRALIZADO DE LA PROVINCIA DEL PASTAZA

PROYECTO " CONSTRUCCIÓN DE LOS HANGARES DEL GOBIERNO AUTÓNOMO DESCENTRALIZADO PROVINCIAL DE PASTAZA (GADPP2) I ETAPA, PARROQUIA FÁTIMA, CANTÓN Y PROVINCIA DE PLANILLA DE AVANCE DE OBRA No. 23

RUBRO N° 121 ANEXO 1
 DESCRIPCIÓN: mALLA ELECTROSOLDADA 15X15X6mm
 UNIDAD: m2
 PERIODO: 01-jun 30-jun



PAG. 1 DE 1

mALLA ELECTROSOLDADA 15X15X6mm						
TRAMPAS DE GRASA DEL PROYECTO						
DESCRIPCION	LARGO (X)	ANCHO (Y)	ALTO (Z)	No.	SUBTOTAL	TOTAL
TRAMPA DE GRASA 1 MEC. LIVIANA						
TRAMPA DE GRASA BASE - LOSA	2,45	0,85		2,00	4,17	4,17
TRAMPA DE GRASA PARED 1	0,85		2,25	2,00	3,83	3,83
TRAMPA DE GRASA PARED 2	2,45		2,25	2,00	11,03	11,03
TRAMPA DE GRASA 2 MEC. PESADA						
TRAMPA DE GRASA BASE - LOSA	3,50	1,20		4,00	16,80	16,80
TRAMPA DE GRASA PARED 1	1,20		2,25	4,00	10,80	10,80
TRAMPA DE GRASA PARED 2	3,50		2,25	4,00	31,50	31,50
TRAMPA DE GRASA 1 MEC. LIVIANA - 3 LAVADO ENGRASADO						
TRAMPA DE GRASA BASE - LOSA	2,45	0,85		2,00	4,17	4,17
TRAMPA DE GRASA PARED 1	0,85		2,25	2,00	3,83	3,83
TRAMPA DE GRASA PARED 2	2,45		2,25	2,00	11,03	11,03
TOTAL						97,16

RESUMEN DE PLANILLA AL 100%					
DESCRIPCION	CONTRATADO	ANTERIOR	ACTUAL	ACUMULADO	UNIDAD
mALLA ELECTROSOLDADA 15X15X6mm	14.243,58	13.519,61	50,85	13.570,46	m2



 CONTRATISTA



 FISCALIZACIÓN

GOBIERNO AUTÓNOMO DESCENTRALIZADO DE LA PROVINCIA DEL PASTAZA

PROYECTO " CONSTRUCCIÓN DE LOS HANGARES DEL GOBIERNO AUTÓNOMO DESCENTRALIZADO PROVINCIAL DE PASTAZA (GADPPz) I ETAPA, PARROQUIA FÁTIMA, CANTÓN Y PROVINCIA DE PLANILLA DE AVANCE DE OBRA No. 23

RUBRO N° 121 ANEXO 1
 DESCRIPCIÓN: mALLA ELECTROSOLDADA 15X15X6mm
 UNIDAD: m2
 PERIODO: 01-jun 30-jun



PAG. 1 DE 1

mALLA ELECTROSOLDADA 15X15X6mm						
BASES PARA GENERADORES INTERNOS Y EXTERNOS						
DESCRIPCION	LARGO (X)	ANCHO (Y)	ALTO (Z)	No.	SUBTOTAL	TOTAL
BASE PARA GENERADORES ADM PB						
BASE 1	1,65	1,30		2,00	4,29	4,29
PARED 1	1,30		1,10	2,00	2,86	2,86
PARED 2	1,65		1,10	3,00	5,45	5,45
DESCUENTO	1,25	0,50		-1,00	-0,63	-0,63
BASES PARA CUARTO ELECTROGENO ADM PB						
BASE 2	3,25	1,30		2,00	8,45	8,45
PARED 1	1,30		1,10	2,00	2,86	2,86
PARED 2	1,65		1,10	2,00	3,63	3,63
BASE PARA GENERADORES EXTERIOR VIA C						
BASE 3	1,65	1,30		2,00	4,29	4,29
PARED 1	1,30		1,10	2,00	2,86	2,86
PARED 2	1,65		1,10	3,00	5,45	5,45
DESCUENTO	1,25	0,50		-1,00	-0,63	-0,63
BASE PARA GENERADORES LAVADO ENGRASADO						
BASE 4	1,65	1,30		2,00	4,29	4,29
PARED 1	1,30		1,10	2,00	2,86	2,86
PARED 2	1,65		1,10	3,00	5,45	5,45
DESCUENTO	1,25	0,50		-1,00	-0,63	-0,63
TOTAL 2						50,85

CONTRATISTA

FISCALIZACIÓN



PROYECTO:

RUBRO	121
DESCRIPCION	mALLA ELECTROSOLDADA 15X15X6mm
UNIDAD	m ²
PERIODO	1 DE JUNIO 2021 A 30 DE JUNIO 2021

ANEXO: 1

PLANTA DE TRANPA DE GRASA 1
MEC. LIVIANA

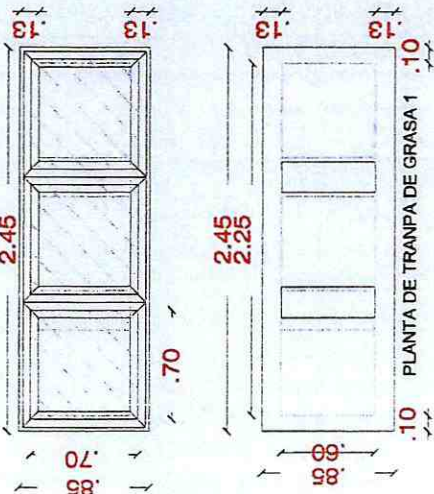

PLANTA DE TRANPA DE GRASA 2
MEC. PESADA

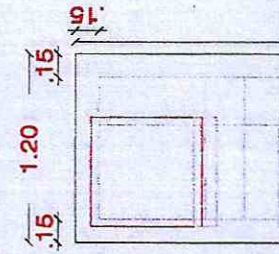
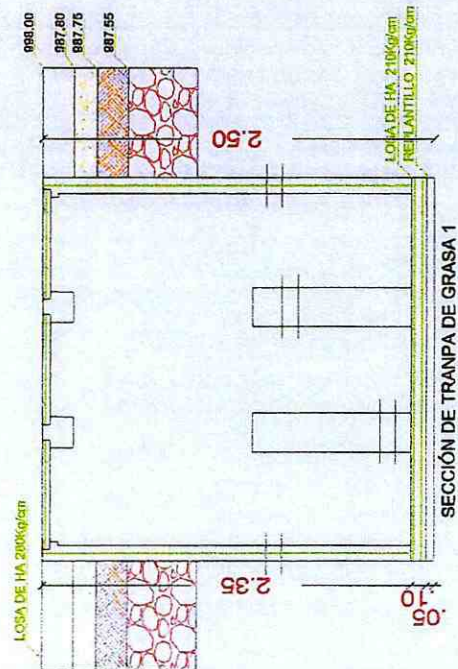
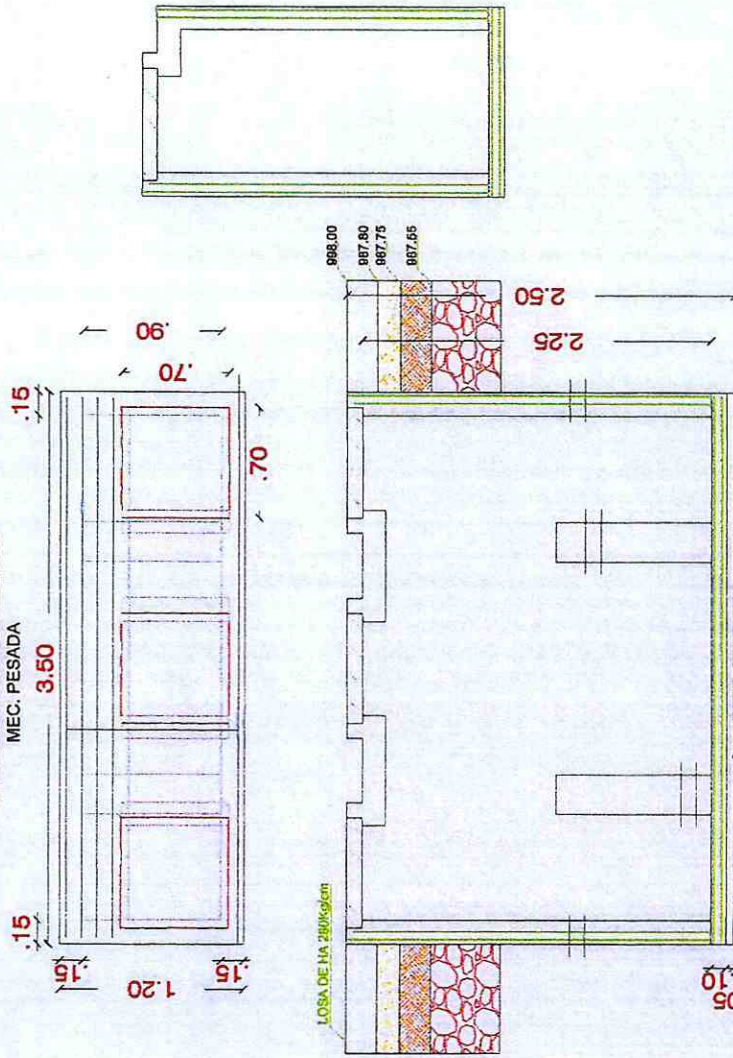

UBICACION - GARTITA # 1

CONTRATISTA

FISCALIZACIÓN

GOBIERNO AUTONOMO DESCENTRALIZADO DE LA
PROVINCIA DEL PASTAZA

" CONSTRUCCIÓN DE LOS HANGARES DEL GOBIERNO AUTÓNOMO DESCENTRALIZADO PROVINCIAL DE PASTAZA
(GADPPZ) I ETAPA, PARROQUIA FÁTIMA, CANTÓN Y PROVINCIA DE PASTAZA "



PROYECTO:	121	ANEXO: 1
RUBRO	mALLA ELECTROSOLDADA 15X15X6mm	
DESCRIPCION	m2	
UNIDAD	1 DE JUNIO 2021 A 30 DE JUNIO 2021	
PERIODO		

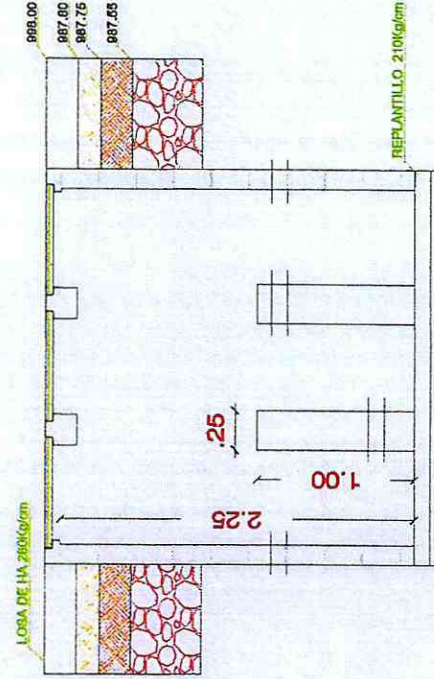
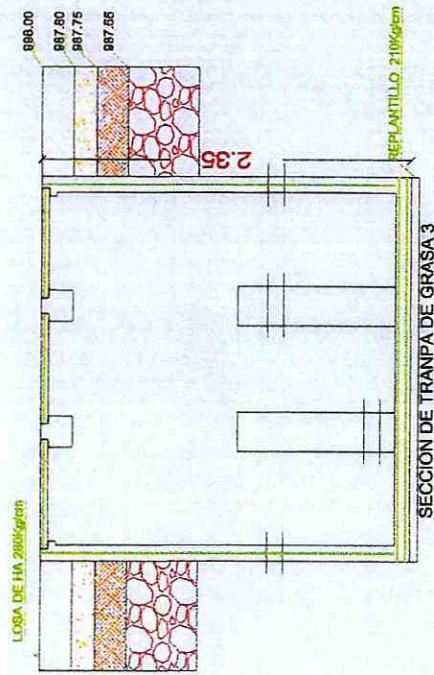
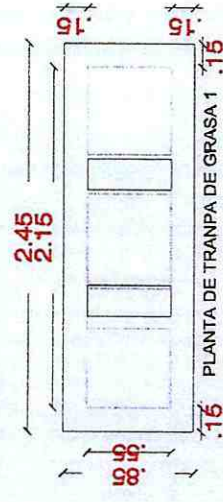
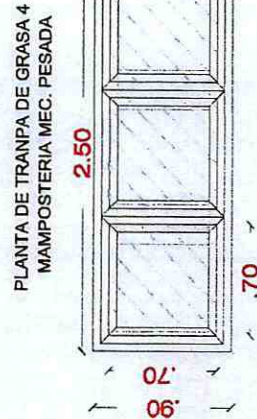
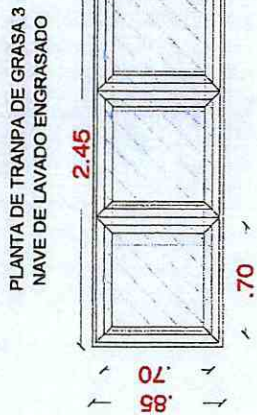

UBICACION - GARITA # 1

FISICIZACION

CONTRATISTA

GOBIERNO AUTONOMO DESCENTRALIZADO DE LA
PROVINCIA DEL PASTAZA

" CONSTRUCCIÓN DE LOS HANGARES DEL GOBIERNO AUTÓNOMO DESCENTRALIZADO PROVINCIAL DE PASTAZA
(GADPPz) I ETAPA, PARROQUIA FÁTIMA, CANTÓN Y PROVINCIA DE PASTAZA "

ANEXO: 1

RUBRO	121
DESCRIPCION	mALLA ELECTROSOLDADA 15X15X6mm
UNIDAD	m ²
PERIODO	1 DE JUNIO 2021 A 30 DE JUNIO 2021

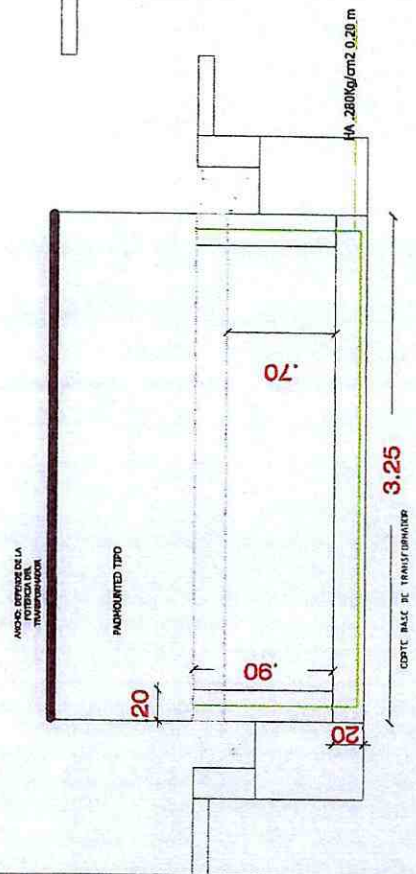
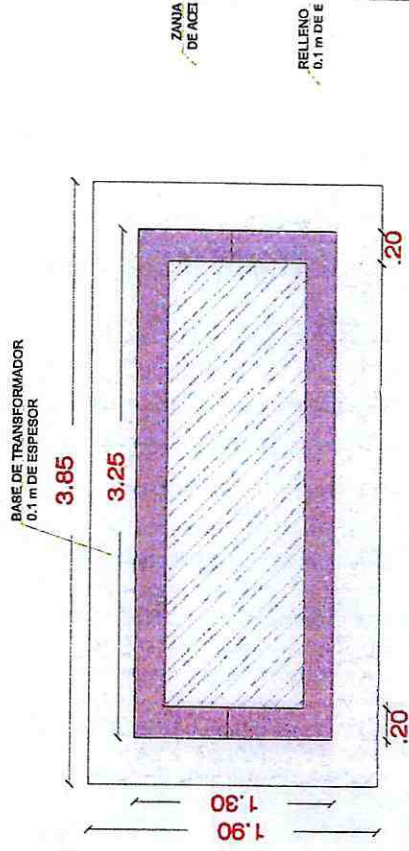
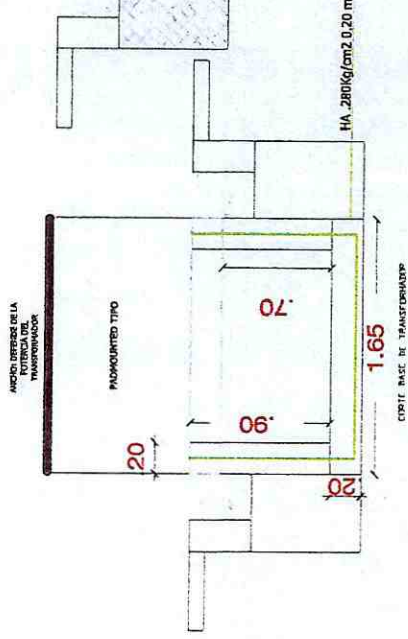
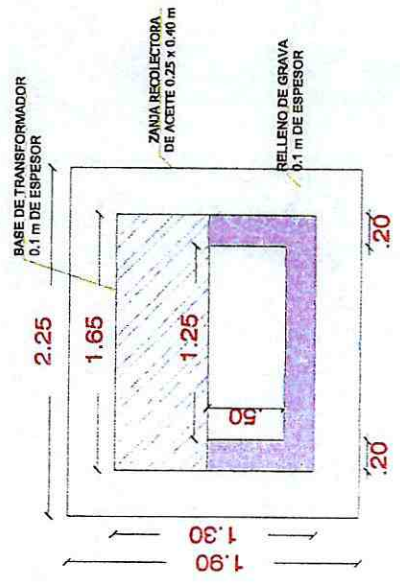

[Signature]
CONTRATISTA

UBICACION - GARITA # 1

[Signature]
FINALIZACION

GOBIERNO AUTÓNOMO DESCENTRALIZADO DE LA PROVINCIA DEL PASTAZA

PROYECTO " CONSTRUCCIÓN DE LOS HANGARES DEL GOBIERNO AUTÓNOMO DESCENTRALIZADO PROVINCIAL DE PASTAZA (GADPPP2) I ETAPA, PARROQUIA FÁTIMA, CANTÓN Y PROVINCIA DE PASTAZA "

PLANILLA DE AVANCE DE OBRA No. 23

RUBRO N° 128 ANEXO 1
 DESCRIPCIÓN: PINTURA EPOXICA PISO INDUSTRIAL 3mm (2 COMPONENTES)
 UNIDAD: m2
 PERIODO: 01-jun 30-jun



PAG. 1 DE 2

PINTURA EPOXICA EN NAVE PRINCIPAL (BODEGA GENERAL)

DESCRIPCION	LARGO (X)	ANCHO (Y)	ALTO (Z)	No.	SUBTOTAL	TOTAL
PINTURA EPOXICA EN NAVE PRINCIPAL (BODEGA GENERAL)	20,48	8,24		1	168,76	168,76

DESCUENTO DE COLUMNAS						
D1	0,40	0,65		-4,00	-1,04	-1,04
D2	0,64	0,75		-4,00	-1,92	-1,92
D3	0,40	0,68		-3,00	-0,82	-0,82
D4	0,68	0,75		-2,00	-1,02	-1,02
TOTAL						163,96

RESUMEN DE PLANILLA AL 100%					
DESCRIPCION	CONTRATADO	ANTERIOR	ACTUAL	ACUMULADO	UNIDAD
PINTURA EPOXICA PISO INDUSTRIAL 3mm (2 COMPONENTES)	5.101,87	2.125,62	163,96	2.289,58	m2



 CONTRATISTA



 FISCALIZACIÓN

GOBIERNO AUTONOMO DESCENTRALIZADO DE LA PROVINCIA DEL PASTAZA

"CONSTRUCCIÓN DE LOS HANGARES DEL GOBIERNO AUTÓNOMO DESCENTRALIZADO PROVINCIAL DE PASTAZA (GADPPz) I ETAPA, PARROQUIA FÁTIMA, CANTÓN Y PROVINCIA DE PASTAZA"

ANEXO: 1

128
PINTURA EPOXICA PISO INDUSTRIAL 3mm (2 COMPONENTES)
m2
01 DE JUNIO 2021 A 30 DE JUNIO 2021

PROYECTO:

RUBRO
DESCRIPCION
UNIDAD
PERIODO

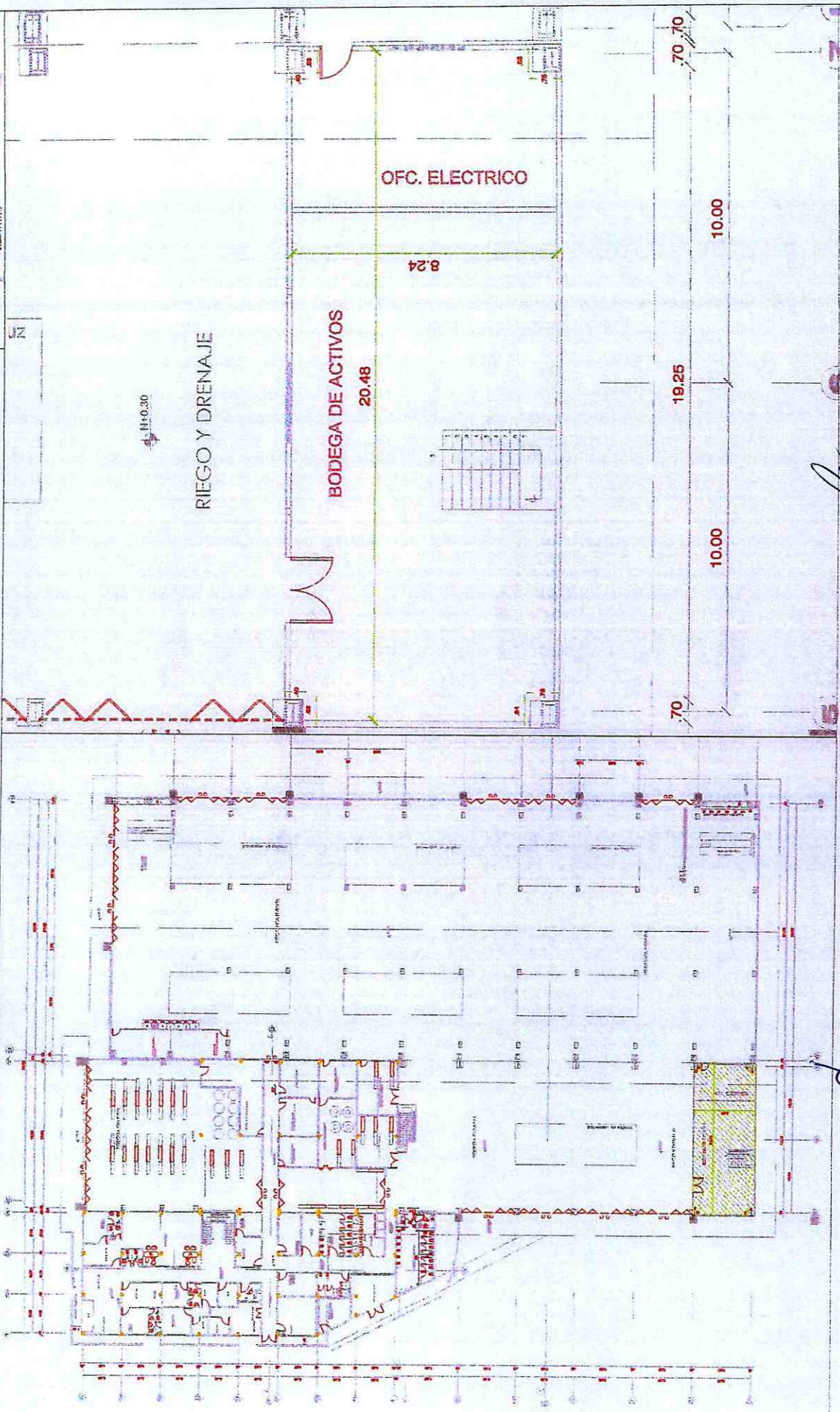

CONTRATISTA

FISCALIZACIÓN

GOBIERNO AUTÓNOMO DESCENTRALIZADO DE LA PROVINCIA DEL PASTAZAS

PROYECTO "CONSTRUCCIÓN DE LOS HANGARES DEL GOBIERNO AUTÓNOMO DESCENTRALIZADO PROVINCIAL DE PASTAZA (GADPPz) I ETAPA, PARROQUIA FÁTIMA, CANTÓN Y PROVINCIA DE PASTAZA "

PLANILLA DE AVANCE DE OBRA No. 23

RUBRO N° 129 ANEXO 1
 DESCRIPCIÓN: PISO PORCELANATO RECTIF. COLOR (0.50X0.50- u OTROS) INSTAL. EmPO
 UNIDAD: m2
 PERIODO: 01-jun 30-jun



1 DE 1

PISO PORCELANATO RECTIF. COLOR (0.50X0.50- u OTROS) INSTAL. EmPO						
GARITAS 1-2						
DESCRIPCION	LARGO (X)	ANCHO (Y)	ALTO (Z)	No.	SUBTOTAL	TOTAL
A1	2,20	3,10		1,00	6,82	6,82
	0,90	0,20		1,00	0,18	0,18
	1,40	1,06		1,00	1,48	1,48
	0,70	0,15		2,00	0,11	0,21
	1,25	1,89		1,00	2,36	2,36
A2	2,29	2,20		1,00	5,04	5,04
	0,70	0,20		2,00	0,14	0,28
	1,70	1,20		1,00	2,04	2,04
					TOTAL	18,41

RESUMEN DE PLANILLA DE INCREMENTOS						
DESCRIPCION	CONTRATADO	ANTERIOR	ACTUAL	INCR. ANT.	INCR. ACT.	UNIDAD
PISO PORCELANATO RECTIF. COLOR (0.50X0.50- u OTROS) INSTAL. EmPO	1.910,00	2.190,29		0,00	18,41	m2



 CONTRATISTA



 FISCALIZACIÓN

**GOBIERNO AUTONOMO DESCENTRALIZADO DE LA
PROVINCIA DEL PASTAZA**

* CONSTRUCCIÓN DE LOS HANGARES DEL GOBIERNO AUTÓNOMO DESCENTRALIZADO PROVINCIAL DE PASTAZA
(GADPPz) | ETAPA, PARROQUIA FÁTIMA, CANTÓN Y PROVINCIA DE PASTAZA

PROYECTO:

RUBRO	128	ANEXO: 1
DESCRIPCIÓN	PISO PORCELANATO RECTIF. COLOR (0.50X0.50- u OTROS) INSTAL. EmPO	
UNIDAD	m ²	
PERIODO	1 DE JUNIO 2021 A 30 DE JUNIO 2021	

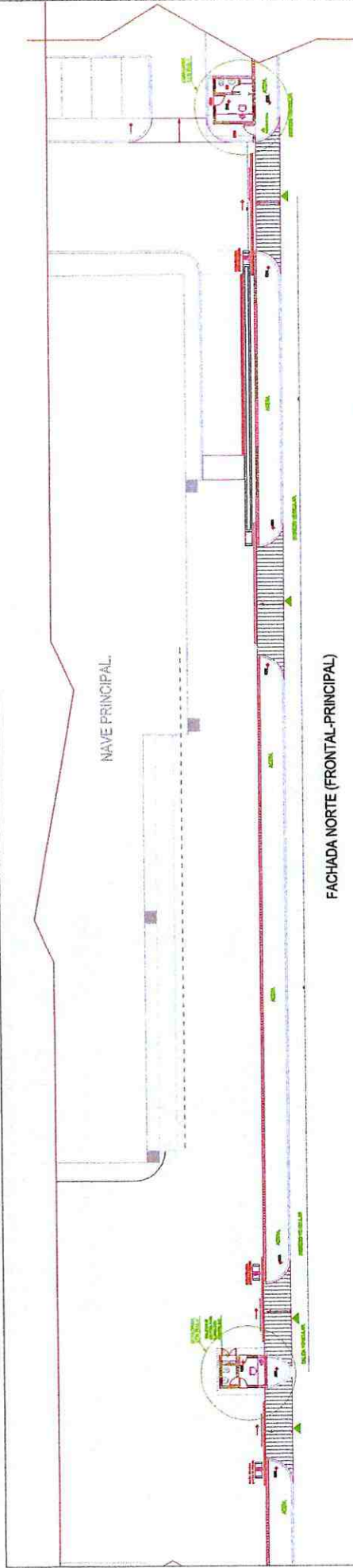

FACHADA NORTE (FRONTAL-PRINCIPAL)

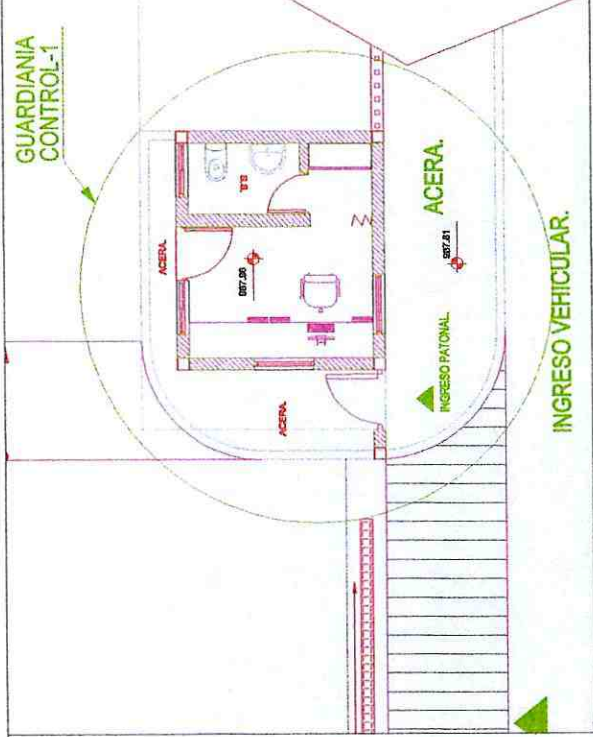
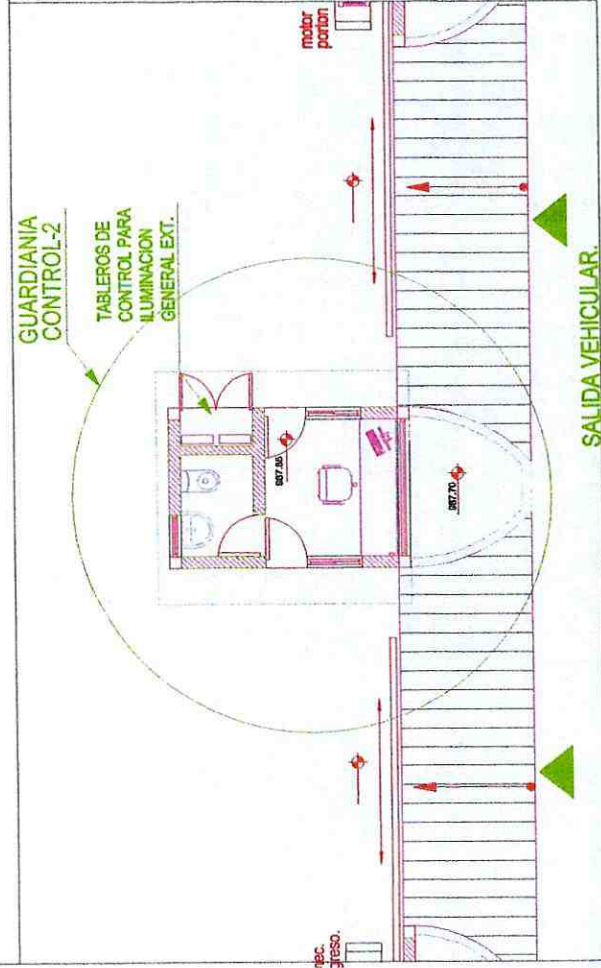

[Signature]
CONTRATISTA

[Signature]
FISCALIZACIÓN

GOBIERNO AUTONOMO DESCENTRALIZADO DE LA
PROVINCIA DEL PASTAZA

" CONSTRUCCIÓN DE LOS HANGARES DEL GOBIERNO AUTÓNOMO DESCENTRALIZADO PROVINCIAL DE PASTAZA
(GADPPz) | ETAPA, PARROQUIA FÁTIMA, CANTÓN Y PROVINCIA DE PASTAZA "

PROYECTO:

129

PISO PORCELANATO RECTIF. COLOR (0.50X0.50- u OTROS) INSTAL. EmPO

m²

1 DE JUNIO 2021 A 30 DE JUNIO 2021

ANEXO: 2

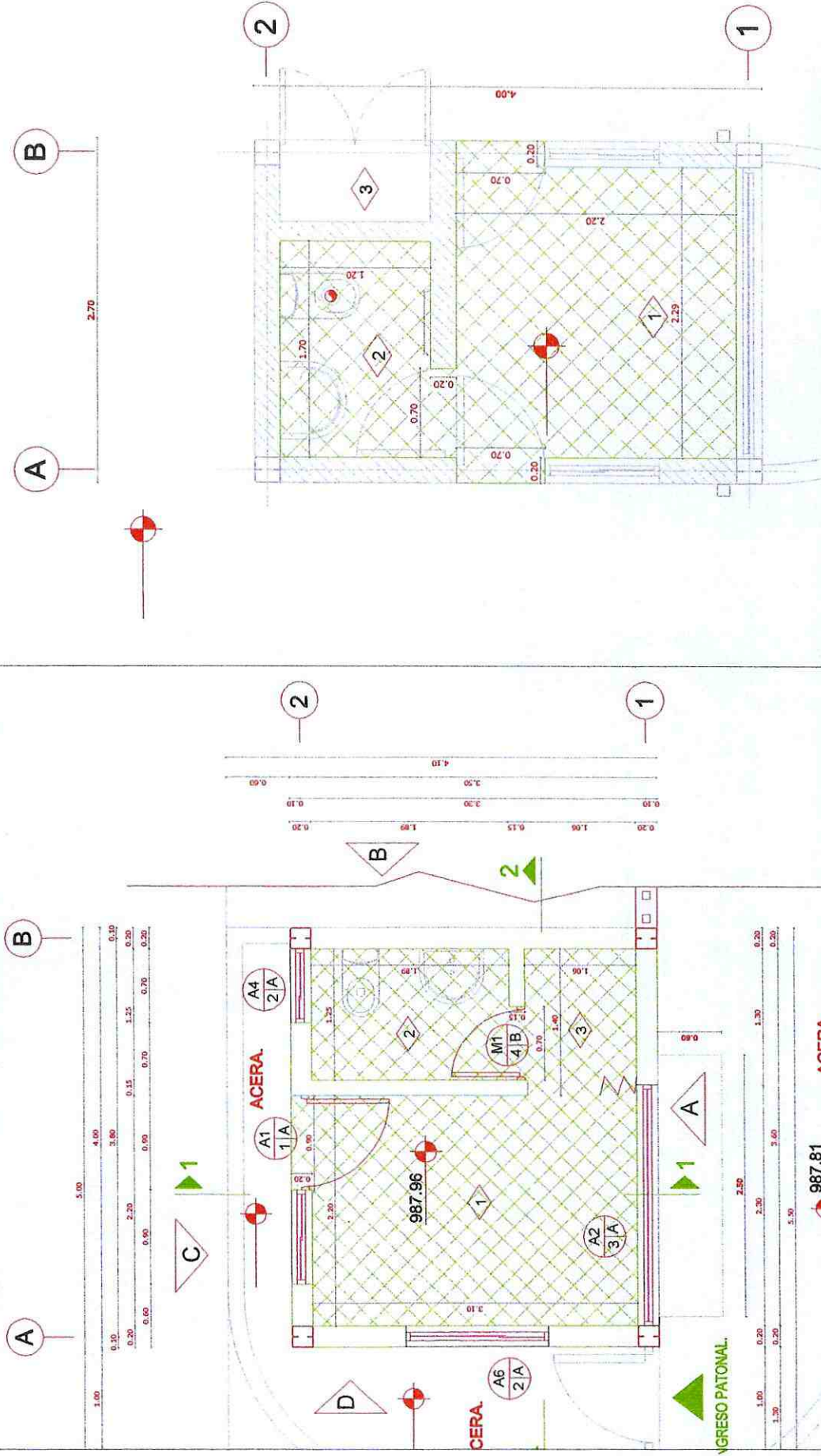

987.81

ACERA

CONTRATISTA

FISCALIZACIÓN

GOBIERNO AUTÓNOMO DESCENTRALIZADO DE LA PROVINCIA DEL PASTAZA

PROYECTO " CONSTRUCCIÓN DE LOS HANGARES DEL GOBIERNO AUTÓNOMO DESCENTRALIZADO PROVINCIAL DE PASTAZA (GADPPz) I ETAPA, PARROQUIA FÁTIMA, CANTÓN Y PROVINCIA DE PLANILLA DE AVANCE DE OBRA No. 23

RUBRO N° 148 ANEXO 1
 DESCRIPCIÓN: mAmPOSTERIA BLOQuE PESADO VIBRADO 4mPAE=15 Cm
 UNIDAD: m2
 PERIODO: 01-jun 30-jun



PAG. 1 DE 1

mAmPOSTERIA BLOQuE PESADO VIBRADO 4mPAE=15 Cm						
TRAMPAS DE GRASA DEL PROYECTO						
DESCRIPCION	LARGO (X)	ANCHO (Y)	ALTO (Z)	No.	SUBTOTAL	TOTAL
TRAMPA DE GRASA 4 MEC. PESADA						
TRAMPA DE GRASA PARED 1	0,55		2,25	2,00	2,48	2,48
TRAMPA DE GRASA PARED 2	2,45		2,25	2,00	11,03	11,03
ANTEPECHO PARED 1	0,55		1,00	1,00	0,55	0,55
ANTEPECHO PARED 2	0,55		1,00	1,00	0,55	0,55
TOTAL						14,61

RESUMEN DE PLANILLA AL 100%					
DESCRIPCION	CONTRATADO	ANTERIOR	ACTUAL	ACUMULADO	UNIDAD
mAmPOSTERIA BLOQuE PESADO VIBRADO 4mPAE=15 Cm	4.630,00	4.078,71	14,61	4.093,32	m2



 CONTRATISTA



 FISCALIZACIÓN

Gobierno Autónomo Descentralizado de la
Provincia del Pastaza

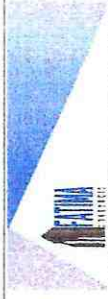

* CONSTRUCCIÓN DE LOS HANGARES DEL GOBIERNO AUTÓNOMO DESCENTRALIZADO PROVINCIAL DE PASTAZA (GADPPz) I ETAPA, PARROQUIA FÁTIMA, CANTÓN Y PROVINCIA DE PASTAZA *

PROYECTO:

RUBRO	1.48	ANEXO: 1
DESCRIPCIÓN	mAmPOSTERIA BLOQUE PESADO VIBRADO 4mPAE=15 Cm	
UNIDAD	m ²	
PERIODO	1 DE JUNIO 2021 A 30 DE JUNIO 2021	

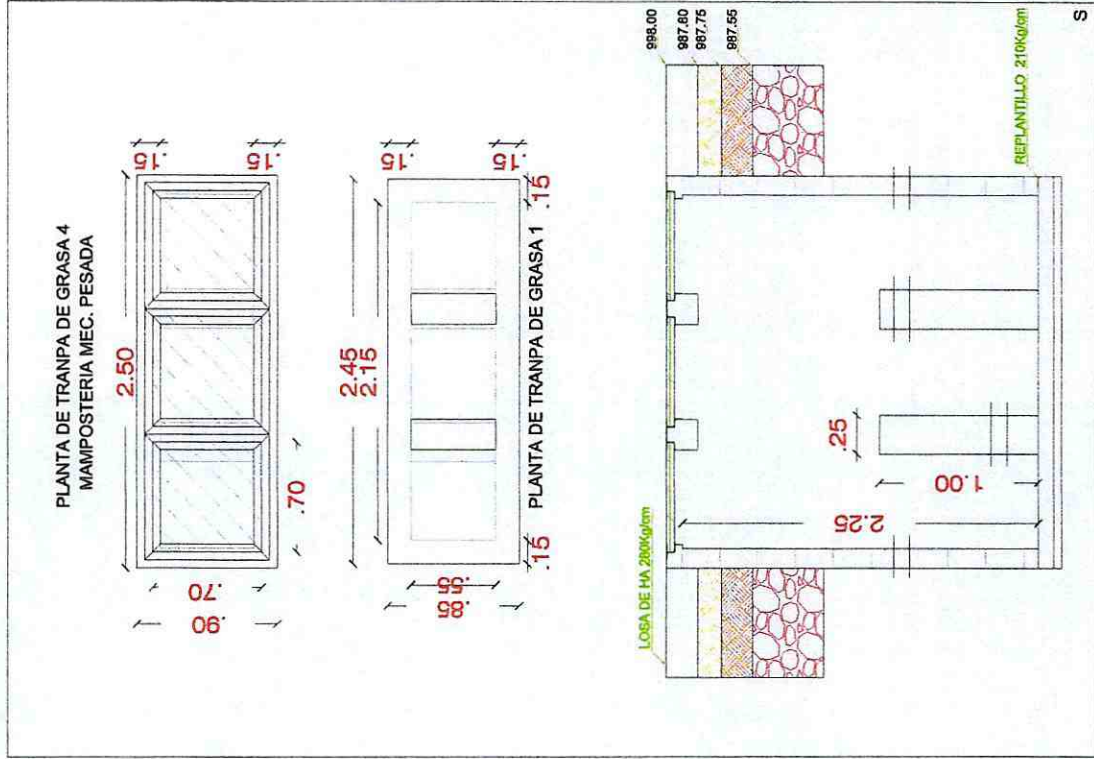

[Signature]

CONTRATISTA

[Signature]

FEALIZACIÓN

GOBIERNO AUTÓNOMO DESCENTRALIZADO DE LA PROVINCIA DEL PASTAZA

PROYECTO " CONSTRUCCIÓN DE LOS HANGARES DEL GOBIERNO AUTÓNOMO DESCENTRALIZADO PROVINCIAL DE PASTAZA (GADPPz) I ETAPA, PARROQUIA FÁTIMA, CANTÓN Y PROVINCIA DE PLANILLA DE AVANCE DE OBRA No. 23

RUBRO N° 149 ANEXO 1
 DESCRIPCIÓN: PICADO Y RESANADO DE mAmPOSTERIA PARA INSTALACIONES
 UNIDAD: m
 PERIODO: 01-jun 30-jun



PAG. 1 DE 1

PICADO Y RESANE DE INSTALACIONES BAÑOS NUEVOS - MEZANINE - OFIC. NUEVAS						
PICADO Y CORCHADO DE TUBERIAS PARA INSTALACIONES ELECTRICAS ELECTRONICAS						
DESCRIPCION	LARGO (X)	ANCHO (Y)	ALTO (Z)	No.	SUBTOTAL	TOTAL
TUB DE DATOS	36,00		2,70		97,20	97,20
TUB DE FUERZA	27,11		2,70		73,20	73,20
TUB DE ILUMINACIÓN	32,00		1,85		59,20	59,20
TUB DE REGULADO	42,00		2,70		113,40	113,40
					SUBTOTAL 3	343,00

RESUMEN DE PLANILLA AL 100%					
DESCRIPCION	CONTRATADO	ANTERIOR	ACTUAL	ACUMULADO	UNIDAD
PICADO Y RESANADO DE mAmPOSTERIA PARA INSTALACIONES	3.819,65	3.476,65	343,00	3.819,65	m



 CONTRATISTA



 FISCALIZACIÓN

" CONSTRUCCIÓN DE LOS HANGARES DEL GOBIERNO AUTÓNOMO DESCENTRALIZADO PROVINCIAL DE PASTAZA (GADPPZ) I ETAPA, PARROQUIA FÁTIMA, CANTÓN Y PROVINCIA DE PASTAZA "

PROYECTO:	ANEXO: 1		
RUBRO	149		
DESCRIPCION	PICADO Y RESANADO DE m	INSTALACIONES	
UNIDAD	m		
PERIODO	1 DE JUNIO 2021 A 30 DE JUNIO 2021		

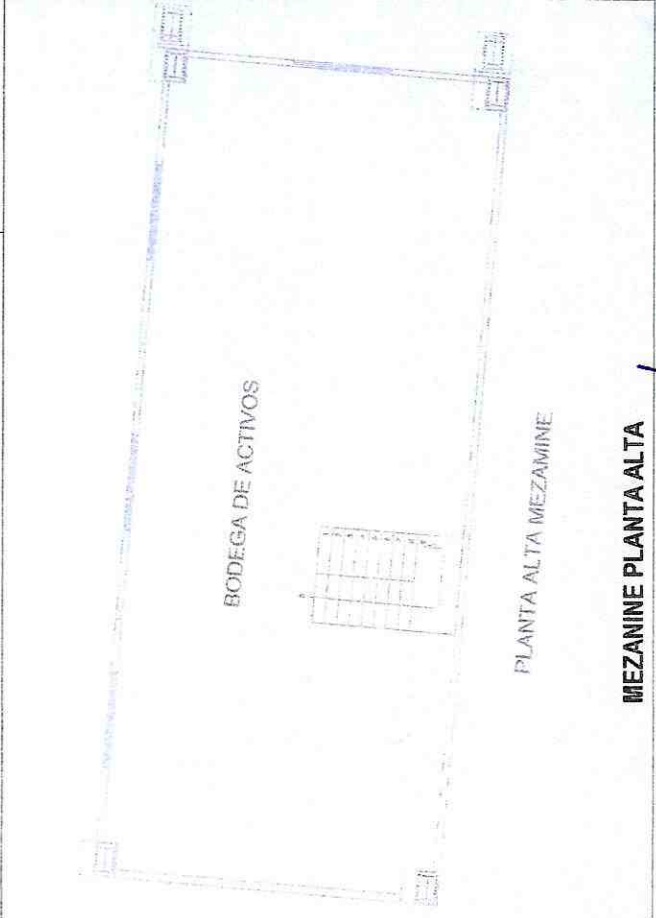
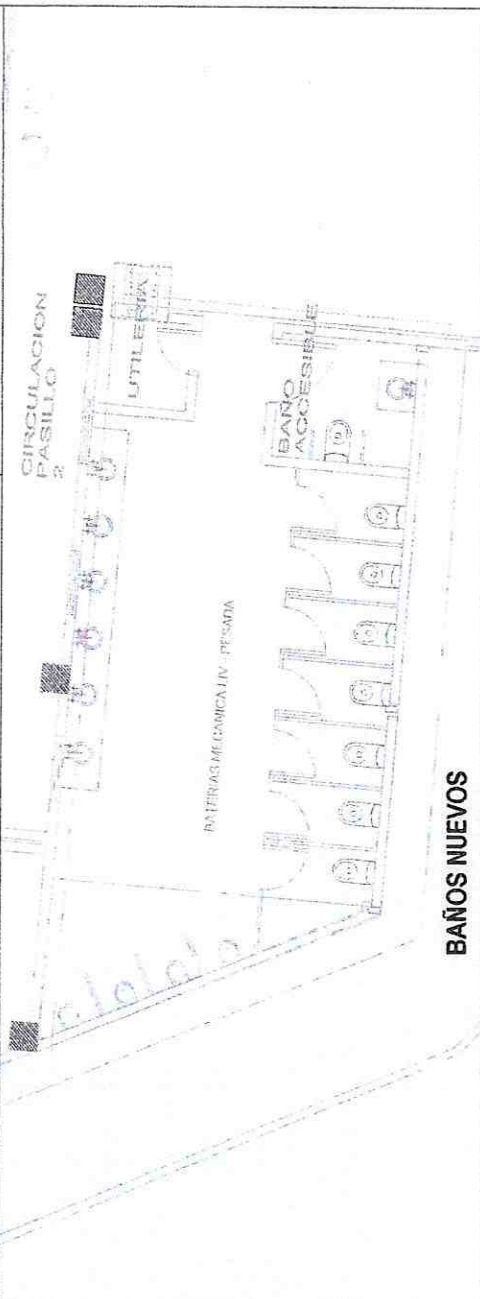

CONTRATISTA

FISCALIZACIÓN

GOBIERNO AUTÓNOMO DESCENTRALIZADO DE LA PROVINCIA DEL PASTAZA

PROYECTO " CONSTRUCCIÓN DE LOS HANGARES DEL GOBIERNO AUTÓNOMO DESCENTRALIZADO PROVINCIAL DE PASTAZA (GADPPz) I ETAPA, PARROQUIA FÁTIMA, CANTÓN Y PLANILLA DE AVANCE DE OBRA No. 23

RUBRO N° 150 ANEXO 1
 DESCRIPCIÓN: mESON H.A. F'C=180 KG/Cm2 E=7 Cm HIERRO (LAVAmANOS+mESON)
 UNIDAD: m
 PERIODO: 01-jun 30-jun



PAG. 1 DE 1

mESON H.A. F'C=180 KG/Cm2 E=7 Cm HIERRO (LAVAmANOS+mESON)

DESCRIPCION	LARGO (X)	ANCHO (Y)	ALTO (Z)	No.	SUBTOTAL	TOTAL
AREA 1	2,78			1,00	2,78	2,78
	5,28			1,00	5,28	5,28
	3,75			1,00	3,75	3,75
	3,80			1,00	3,80	3,80
AREA 2	5,59			1,00	5,59	5,59
AREA 3	7,85			1,00	7,85	7,85
AREA 4	7,10			1,00	7,10	7,10
AREA 5	7,10			1,00	7,10	7,10

TOTAL	43,25
-------	-------

RESUMEN DE PLANILLA AL 100%					
DESCRIPCION	CONTRATADO	ANTERIOR	ACTUAL	ACUMULADO	UNIDAD
mESON H.A. F'C=180 KG/Cm2 E=7 Cm HIERRO (LAVAmANOS+mESON)	7,00	20,40		20,40	m

RESUMEN DE PLANILLA DE INCREMENTOS						
DESCRIPCION	CONTRATADO	ANTERIOR	ACTUAL	INCR. ANT.	INCR. ACT.	UNIDAD
mESON H.A. F'C=180 KG/Cm2 E=7 Cm HIERRO (LAVAmANOS+mESON)	7,00	20,40	0,00	0,00	43,25	m



 CONTRATISTA

 FISCALIZACIÓN

BIENIO AUTONOMO DESCENTRALIZADO DE LA PROVINCIA DEL PASTAZA

" CONSTRUCCIÓN DE LOS HANGARES DEL GOBIERNO AUTÓNOMO DESCENTRALIZADO PROVINCIAL DE PASTAZA (GADPPP) I ETAPA, PARROQUIA FÁTIMA, CANTÓN Y PROVINCIA DE PASTAZA "

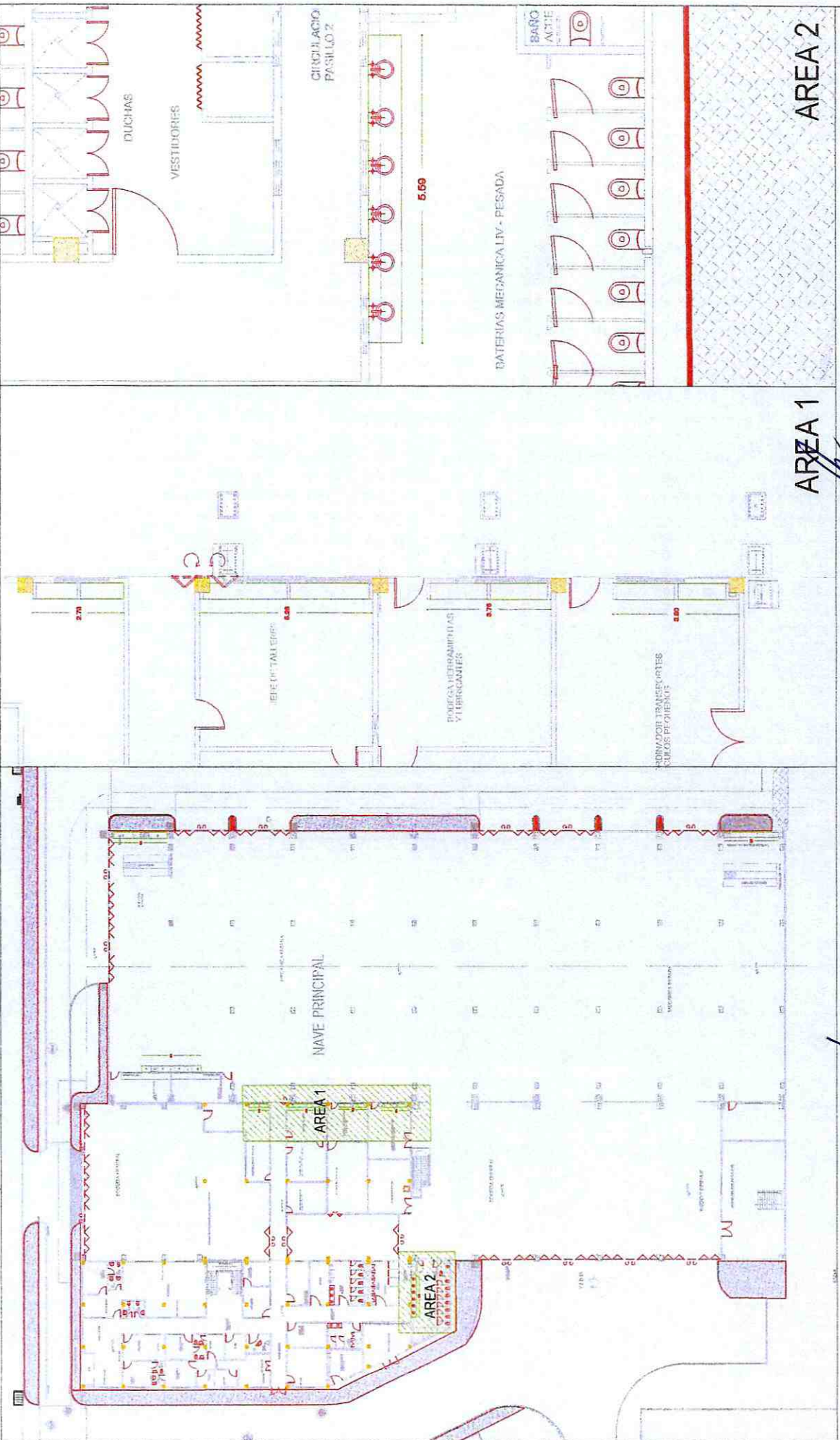
PROYECTO:	150
RUBRO DESCRIPCION UNIDAD PERIODO	m ² ESÓN H.A. FC=180 KG/Cm ² E=7 Cm HIERRO (LAVAMANOS+MESON)
	01 DE JUNIO 2021 A 30 DE JUNIO 2021
	ANEXO: 1



AREA 2

AREA 1

CONTRATISTA

FISCALIZACIÓN

BIERNO AUTONOMO DESCENTRALIZADO DE LA PROVINCIA DEL PASTAZA

" CONSTRUCCIÓN DE LOS HANGARES DEL GOBIERNO AUTÓNOMO DESCENTRALIZADO PROVINCIAL DE PASTAZA (GADPPZ) | ETAPA, PARROQUIA FÁTIMA, CANTÓN Y PROVINCIA DE PASTAZA "

PROYECTO:

RUBRO	150
DESCRIPCION	mESON H.A. FC=180 KG/Cm2 E=7 Cm HIERRO (LAVAMANOS+mESON)
UNIDAD	m
PERIODO	01 DE JUNIO 2021 A 30 DE JUNIO 2021

ANEXO: 2

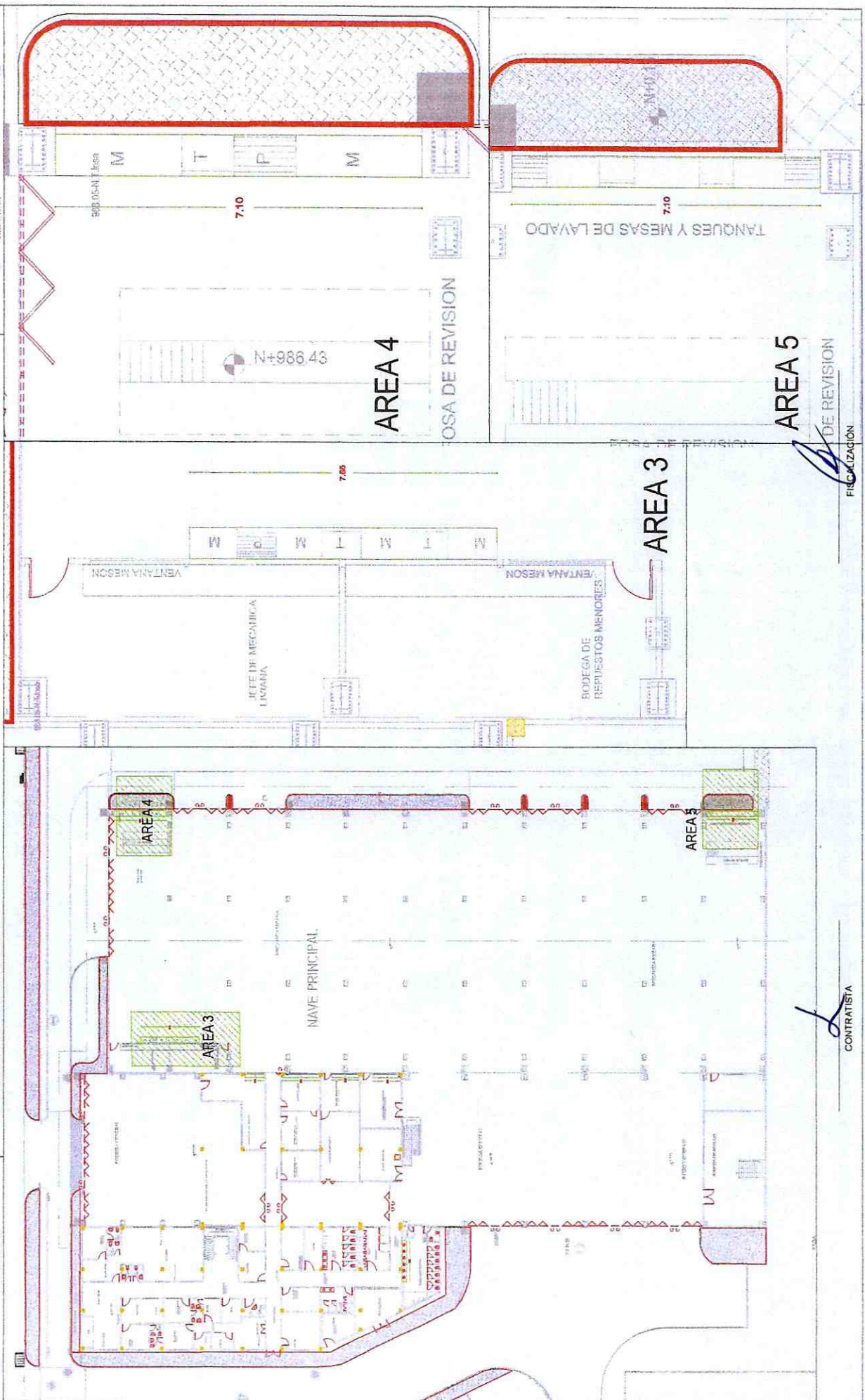

CONTRATISTA

FIGURACION

GOBIERNO AUTÓNOMO DESCENTRALIZADO DE LA PROVINCIA DEL PASTAZA

PROYECTO " CONSTRUCCIÓN DE LOS HANGARES DEL GOBIERNO AUTÓNOMO DESCENTRALIZADO PROVINCIAL DE PASTAZA (GADPPz) I ETAPA, PARROQUIA FÁTIMA, CANTÓN Y PROVINCIA DE PLANILLA DE AVANCE DE OBRA No. 23

RUBRO N° 153 ANEXO 1
 DESCRIPCIÓN: ENLUCIDO VERTICAL PALETEADO mORTERO 1:3 (INTERIOR)
 UNIDAD: m2
 PERIODO: 01-jun 30-jun



PAG. 1 DE 1

ENLUCIDO VERTICAL PALETEADO mORTERO 1:3 (INTERIOR)						
TRAMPAS DE GRASA DEL PROYECTO						
DESCRIPCION	LARGO (X)	ANCHO (Y)	ALTO (Z)	No.	SUBTOTAL	TOTAL
TRAMPA DE GRASA 4 MEC. PESADA						
TRAMPA DE GRASA PARED 1	0,55		2,25	2,00	2,48	2,48
TRAMPA DE GRASA PARED 2	2,15		2,25	2,00	9,68	9,68
ANTEPECHO PARED 1	2,25		0,55	1,00	1,24	1,24
ANTEPECHO PARED 2	2,25		0,55	1,00	1,24	1,24
TOTAL						14,64

RESUMEN DE PLANILLA AL 100%					
DESCRIPCION	CONTRATADO	ANTERIOR	ACTUAL	ACUMULADO	UNIDAD
ENLUCIDO VERTICAL PALETEADO mORTERO 1:3 (INTERIOR)	9.060,97	7.942,58	14,64	7.957,22	m2



 CONTRATISTA



 FISCALIZACIÓN

**GOBIERNO AUTONOMO DESCENTRALIZADO DE LA
PROVINCIA DEL PASTAZA**

" CONSTRUCCIÓN DE LOS HANGARES DEL GOBIERNO AUTÓNOMO DESCENTRALIZADO PROVINCIAL DE PASTAZA
(GADPPP) I ETAPA, PARROQUIA FÁTIMA, CANTÓN Y PROVINCIA DE PASTAZA "

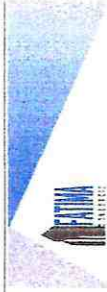

ANEXO: 1

1.5.3

ENLUCIDO VERTICAL PALETEADO MORTERO 1:3 (INTERIOR)

m²

1 DE JUNIO 2021 A 30 DE JUNIO 2021

PROYECTO:

RUBRO
DESCRIPCION
UNIDAD
PERIODO

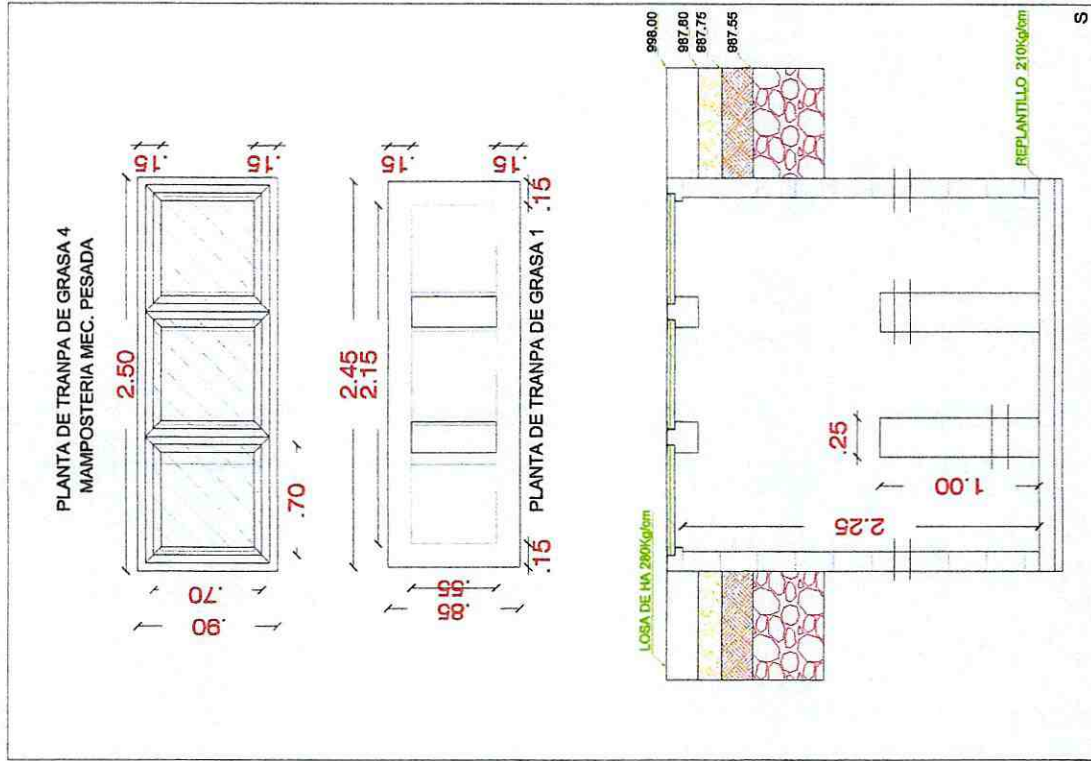

[Signature]
CONTRATISTA

[Signature]
FISCALIZACIÓN

GOBIERNO AUTÓNOMO DESCENTRALIZADO DE LA PROVINCIA DEL PASTAZAS

PROYECTO "CONSTRUCCIÓN DE LOS HANGARES DEL GOBIERNO AUTÓNOMO DESCENTRALIZADO PROVINCIAL DE PASTAZA (GADPPz) I ETAPA, PARROQUIA FÁTIMA, CANTÓN Y PROVINCIA DE PASTAZA"
 PLANILLA DE AVANCE DE OBRA No. 23

RUBRO N° 176 ANEXO 1
 DESCRIPCIÓN: PuERTA YmAmPARAALumINIOS200YVIDRIOLAmINADO E=8mm CON PIVOTE
 UNIDAD: m2
 PERIODO: 01-may 31-may



PAG. 1 DE 1

PuERTA YmAmPARAALumINIOS200YVIDRIOLAmINADO E=8mm CON PIVOTE						
NAVE PRINCIPAL - OFICINA MECANICA						
DESCRIPCION	LARGO (X)	ANCHO (Y)	ALTO (Z)	No.	SUBTOTAL	TOTAL
A1	2,00	2,10		1,00	4,20	4,20
	2,00	2,10		1,00	4,20	4,20
A2	2,00	2,10		1,00	4,20	4,20
TOTAL					12,60	

RESUMEN DE PLANILLA AL 100%						
DESCRIPCION	CONTRATADO	ANTERIOR	ACTUAL	ACUMULADO	UNIDAD	
Puerta YmAmPARAALumINIOS200YVIDRIOLAmINADO E=8mm CON PIVOTE	9,00	7,88	1,12	9,00	m2	

RESUMEN DE PLANILLA DE INCREMENTOS						
DESCRIPCION	CONTRATADO	ANTERIOR	ACTUAL	INCR. ANT.	INCR. ACT.	UNIDAD
Puerta YmAmPARAALumINIOS200YVIDRIOLAmINADO E=8mm CON PIVOTE	9,00	7,88	12,60	0,00	11,48	m2



 CONTRATISTA



 FISCALIZACIÓN

BIENIO AUTÓNOMO DESCENTRALIZADO DE LA
PROVINCIA DEL PASTAZA

"CONSTRUCCIÓN DE LOS HANGARES DEL GOBIERNO AUTÓNOMO DESCENTRALIZADO PROVINCIAL DE PASTAZA (GADPPZ) ETAPA, PARROQUIA FÁTIMA, CANTÓN Y PROVINCIA DE PASTAZA"

PROYECTO:	176
RUBRO	PUERTA Y ANEXO PARA ALUMINIOS 200 V VÍDRIO LAMINADO E-8mm CON PIVOTE
DESCRIPCIÓN	m ²
UNIDAD	01 DE JUNIO 2021 A 30 DE JUNIO 2021
PERIODO	ANEXO: 1

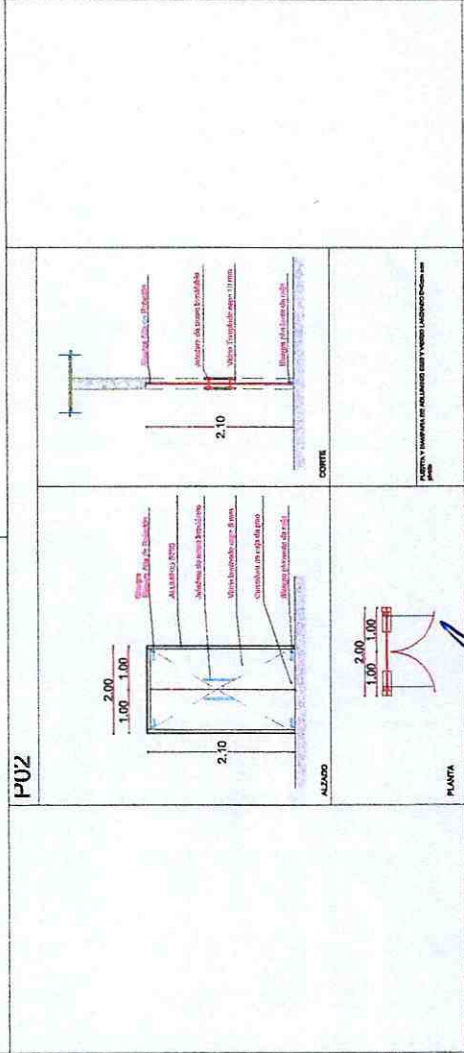
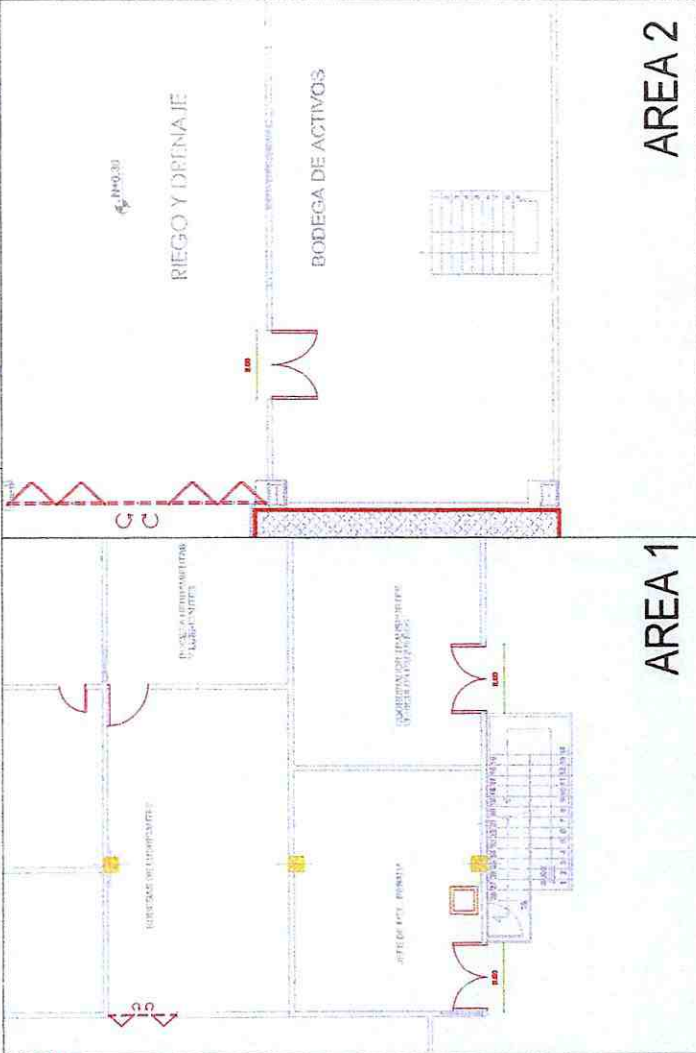

CONTRATISTA

FISCALIZACIÓN

PLANTA

ALZADO

CORTE

GOBIERNO AUTÓNOMO DESCENTRALIZADO DE LA PROVINCIA DEL PASTAZA

PROYECTO " CONSTRUCCIÓN DE LOS HANGARES DEL GOBIERNO AUTÓNOMO DESCENTRALIZADO PROVINCIAL DE PASTAZA (GADPPz) I ETAPA, PARROQUIA FÁTIMA, PLANILLA DE AVANCE DE OBRA No. 23

RUBRO N° 178 ANEXO 1
 DESCRIPCIÓN: PuERTA BATIENTE ALUMINIO Y VIDRIO FLOTADO CLARO 6mm (1.00X2.10)
 UNIDAD: u
 PERIODO: 01-jun 30-jun



PAG. 1 DE 1

PuERTA BATIENTE ALUMINIO Y VIDRIO FLOTADO CLARO 6mm (1.00X2.10)				
NAVE PRINCIPAL- TALLERES-ADMINISTRATIVO-BODEGA GENERAL				
DESCRIPCION	CANTIDAD	DIMENSION	TOTAL	GRAFICO #
PERSONAL BODEGA GENERAL	2,00	-	2,00	ANEXO # 1
COMPRAS PUBLICA Y REPUESTOS	1,00	-	1,00	ANEXO # 1
PERSONAL APORYO JEFATURA TALLERES	1,00	-	1,00	ANEXO # 1
BODEGA HERRAMIENTAS Y LUBRICANTE	1,00	-	1,00	ANEXO # 1
COORDINADOR TRANSPORTES VEHICULOS PEQUEÑOS	1,00	-	1,00	ANEXO # 1
TOTAL			6,00	

RESUMEN DE PLANILLA AL 100%					
DESCRIPCION	CONTRATADO	ANTERIOR	ACTUAL	ACUMULADO	UNIDAD
PuERTA BATIENTE ALUMINIO Y VIDRIO FLOTADO CLARO 6mm (1.00X2.10)	40,00	34,00	6,00	40,00	u

 CONTRATISTA

 FISCALIZACIÓN

" CONSTRUCCIÓN DE LOS HANGARES DEL GOBIERNO AUTÓNOMO DESCENTRALIZADO PROVINCIAL DE PASTAZA
(GADPPZ) I ETAPA, PARROQUIA FÁTIMA, CANTÓN Y PROVINCIA DE PASTAZA "



PROYECTO:	ANEXO: 1
RUBRO	178
DESCRIPCION	PUERTA BATTIENTE ALUMINIO Y VIDRIO FLOTADO CLARO 6mm (1.00X2.10)JADO SATINADO (Juego)
UNIDAD	U
PERIODO	1 DE JUNIO 2021 A 30 DE JUNIO 2021

UBICACION - NAVE PRINCIPAL- BLOQUE ADMINISTRATIVO

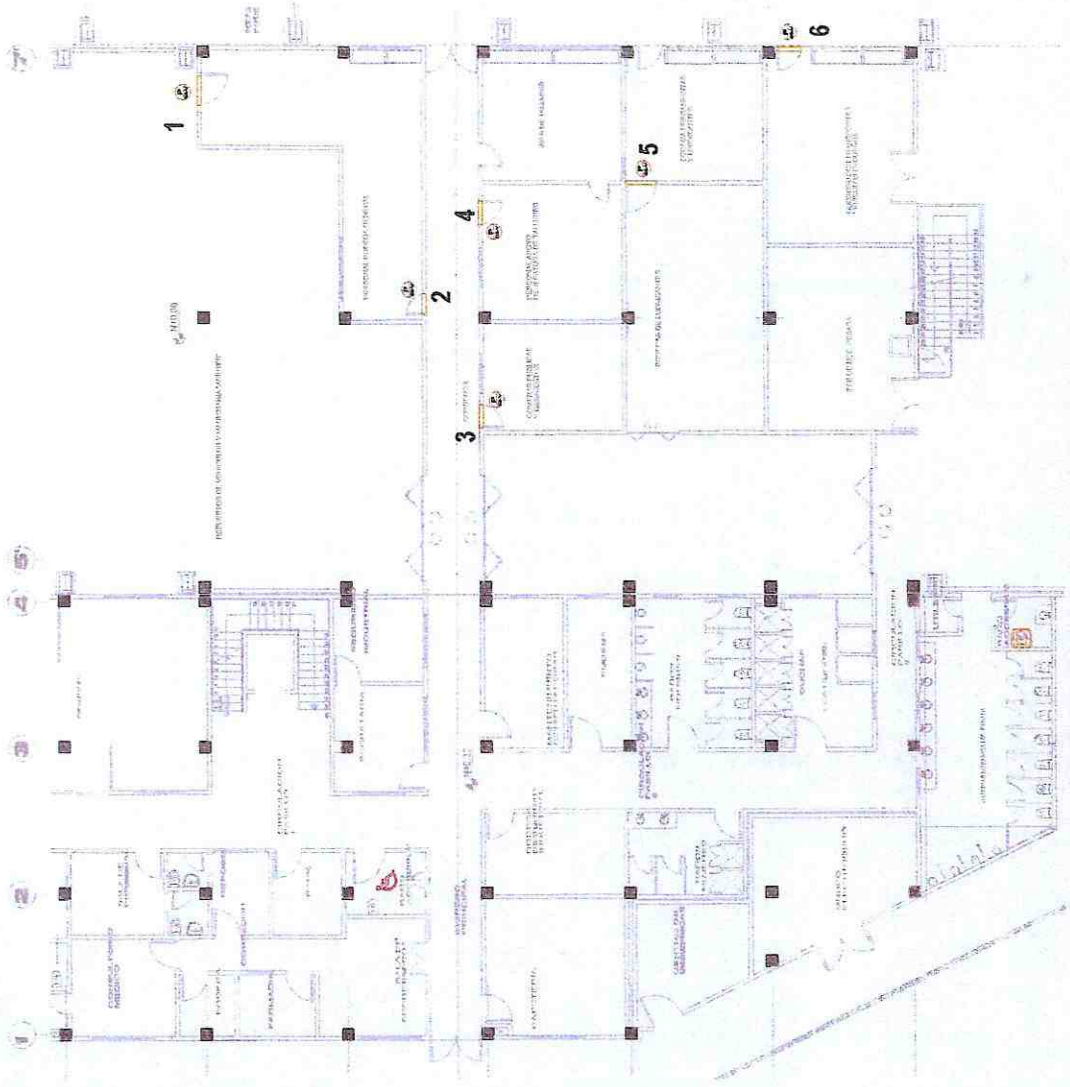
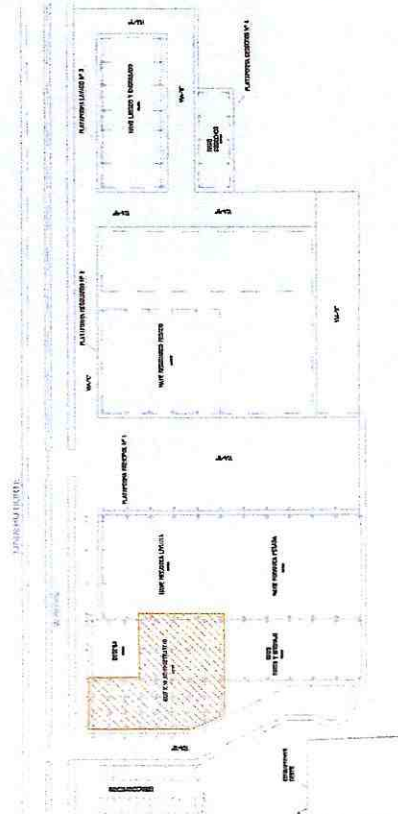

P08-V

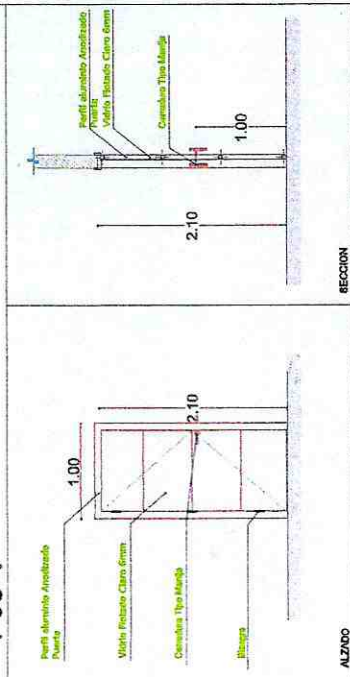

DETALLE TIPICO DE PUERTA

PLANTA BAJA NV+0.30 - BLOQUE ADMINISTRACION

CONTRATISTA

REALIZACION

GOBIERNO AUTÓNOMO DESCENTRALIZADO DE LA PROVINCIA DEL PASTAZA5

PROYECTO " CONSTRUCCIÓN DE LOS HANGARES DEL GOBIERNO AUTÓNOMO DESCENTRALIZADO PROVINCIAL DE PASTAZA (GADPPz) I ETAPA, PARROQUIA FÁTIMA, CANTÓN Y PROVINCIA DE PASTAZA "

PLANILLA DE AVANCE DE OBRA No. 20

RUBRO N° 179 ANEXO 1
 DESCRIPCIÓN: VENTANA CORREDIZA ALUMINIO SERIE 200-INCL. VIDRIO LAMINADO 6mm
 UNIDAD: m2
 PERIODO: 01-may 31-may



PAG. 1 DE 1

VENTANA CORREDIZA ALUMINIO SERIE 200-INCL. VIDRIO LAMINADO 6mm						
NAVE PRINCIPAL - OFICINA MECANICA						
DESCRIPCION	LARGO (X)	ANCHO (Y)	ALTO (Z)	No.	SUBTOTAL	TOTAL
A1 JEFE DE MECANICA	2,40	1,55		2,00	3,72	7,44
A1 BODEGA DE REPUESTOS	2,40	1,20		1,00	2,88	2,88
A2 BODEGA DE ACTIVOS PB	2,40	1,20		2,00	2,88	5,76
A2 BODEGA DE ACTIVOS PA	2,40	1,20		4,00	2,88	11,52
A5						
TOTAL						27,60

RESUMEN DE PLANILLA AL 100%					
DESCRIPCION	CONTRATADO	ANTERIOR	ACTUAL	ACUMULADO	UNIDAD
VENTANA CORREDIZA ALUMINIO SERIE 200-INCL. VIDRIO LAMINADO 6mm	220,00	193,15	26,85	220,00	m2

RESUMEN DE PLANILLA DE INCREMENTOS						
DESCRIPCION	CONTRATADO	ANTERIOR	ACTUAL	INCR. ANT.	INCR. ACT.	UNIDAD
VENTANA CORREDIZA ALUMINIO SERIE 200-INCL. VIDRIO LAMINADO 6mm	220,00	193,15	27,60	0,00	0,75	m2

CONTRATISTA

FISCALIZACIÓN

BIENIO AUTÓNOMO DESCENTRALIZADO DE LA
PROVINCIA DEL PASTAZA

" CONSTRUCCIÓN DE LOS HANGARES DEL GOBIERNO AUTÓNOMO DESCENTRALIZADO PROVINCIAL DE PASTAZA (GADPPz) I ETAPA, PARROQUIA FÁTIMA, CANTÓN Y PROVINCIA DE PASTAZA "

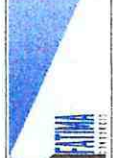

ANEXO: 1

179 VENTANA CORREDIZA ALUMINIO SERIE 200-INCL. VIDRIO LAMINADO 6mm
m²
01 DE JUNIO 2021 A 30 DE JUNIO 2021

PROYECTO:

RUBRO
DESCRIPCION
UNIDAD
PERIODO

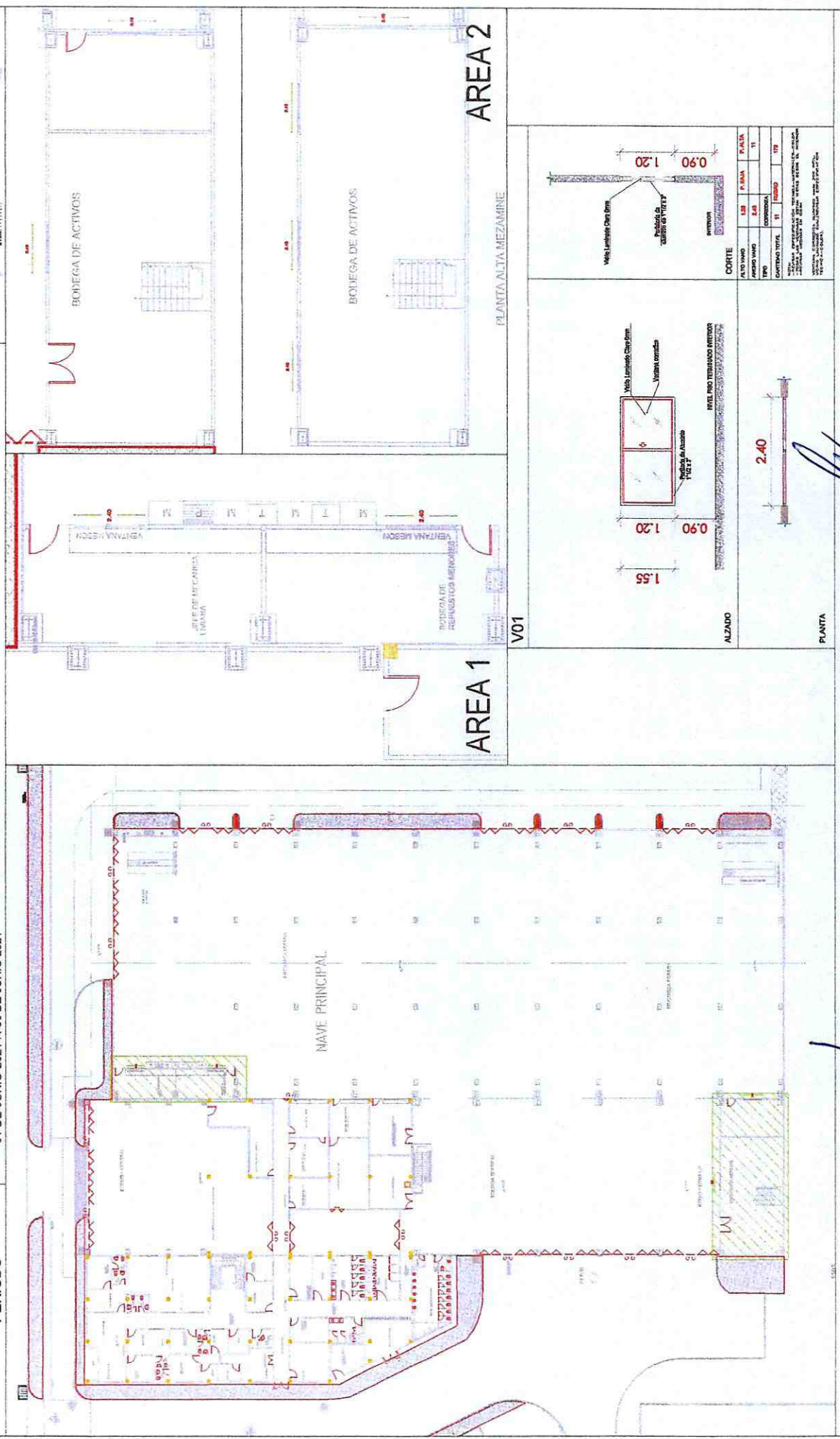

CONTRATISTA

FISCALIZACIÓN

GOBIERNO AUTÓNOMO DESCENTRALIZADO DE LA PROVINCIA DEL PASTAZA

PROYECTO " CONSTRUCCIÓN DE LOS HANGARES DEL GOBIERNO AUTÓNOMO DESCENTRALIZADO PROVINCIAL DE PASTAZA (GADPPz) I ETAPA, PARROQUIA FÁTIMA, CANTÓN Y PROVINCIA DE PLANILLA DE AVANCE DE OBRA No. 23

RUBRO N° 181 ANEXO 1
 DESCRIPCIÓN: CIELO RASO FALSO TIPO GYPSum PARA HumEDAD-1/2"-SIN ESTuCAR
 UNIDAD: m2
 PERIODO: 01-jun 30-jun



1 DE 1

CIELO RASO FALSO TIPO GYPSum PARA HumEDAD-1/2"-SIN ESTuCAR						
DEBAJO DE ESCALERA DEL BLOQUE ADM PB.						
DESCRIPCION	LARGO (X)	ANCHO (Y)	ALTO (Z)	No.	SUBTOTAL	TOTAL
ESCALERA						
ARER 1	3,45	1,20		1,00	4,14	4,14
AREA 2	2,40	1,20		1,00	2,88	2,88
AREA 3	1,20	1,17		1,00	1,40	1,40
AREA 4	1,70	1,17		1,00	1,99	1,99
AREA 5	2,00	2,15		1,00	4,30	4,30
AREA 6	1,15	2,15		1,00	2,47	2,47
TOTAL						17,18

RESUMEN DE PLANILLA AL 100%					
DESCRIPCION	CONTRATADO	ANTERIOR	ACTUAL	ACUMULADO	UNIDAD
CIELO RASO FALSO TIPO GYPSum PARA HumEDAD-1/2"-SIN ESTuCAR	212,58	-	17,18	17,18	m2

 CONTRATISTA

 FISCALIZACIÓN

BIERNO AUTONOMO DESCENTRALIZADO DE LA
PROVINCIA DEL PASTAZA

" CONSTRUCCIÓN DE LOS HANGARES DEL GOBIERNO AUTÓNOMO DESCENTRALIZADO PROVINCIAL DE PASTAZA
(GADPPP2) I ETAPA, PARROQUIA FÁTIMA, CANTÓN Y PROVINCIA DE PASTAZA "

PROYECTO:

RUBRO	181
DESCRIPCION	CIELO RASO FALSO TIPO GYPSUM PARA HumEDAD-12"-SIN ESTUCAR
UNIDAD	m ²
PERIODO	1 DE JUNIO 2021 A 30 DE JUNIO 2021

ANEJO: 1

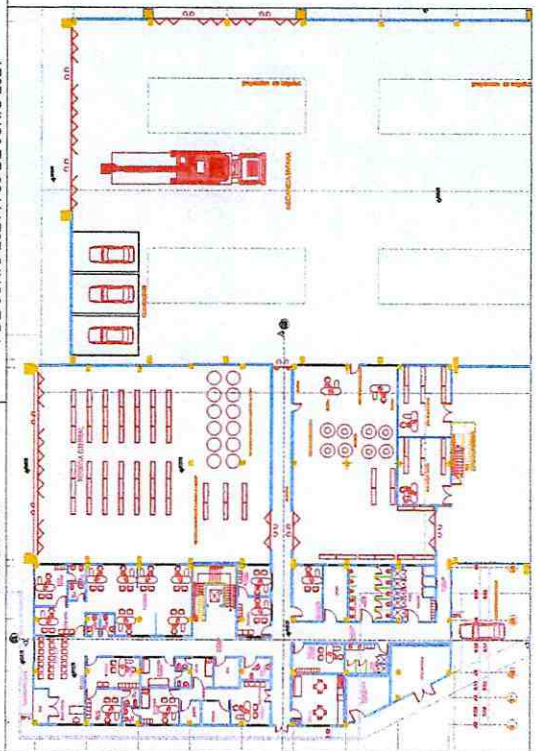
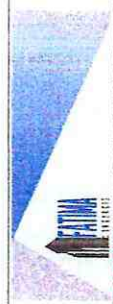

UBICACIÓN: ESCALERA DE BLOQUE ADM

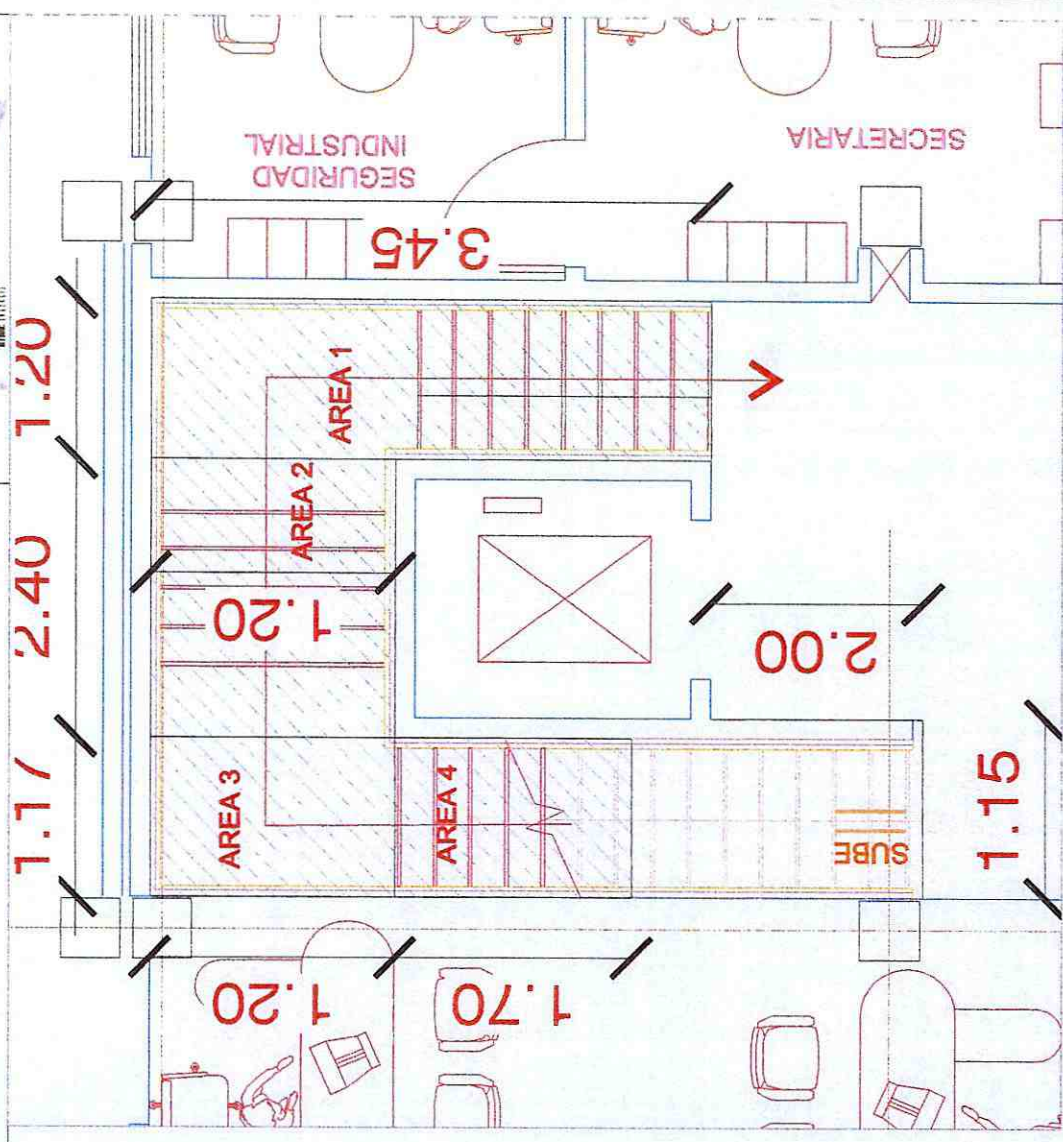
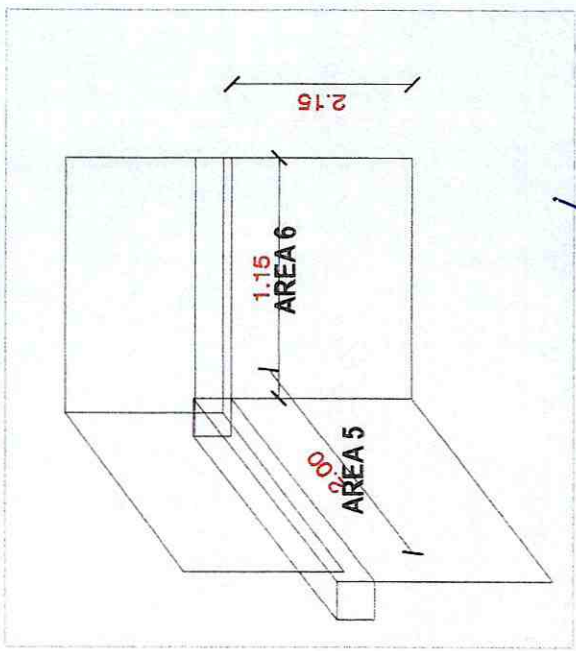

CONTRATISTA

FISCALIZACIÓN

GOBIERNO AUTÓNOMO DESCENTRALIZADO DE LA PROVINCIA DEL PASTAZA

PROYECTO " CONSTRUCCIÓN DE LOS HANGARES DEL GOBIERNO AUTÓNOMO DESCENTRALIZADO PROVINCIAL DE PASTAZA (GADPPz) I ETAPA, PARROQUIA FÁTIMA, CANTÓN Y PROVINCIA DE PLANILLA DE AVANCE DE OBRA No. 23

RUBRO N° 182 ANEXO 1
 DESCRIPCIÓN: ESTUCADO DE CIELO RASO
 UNIDAD: m2
 PERIODO: 01-jun 30-jun



1 DE 1

ESTUCADO DE CIELO RASO						
DEBAJO DE ESCALERA DEL BLOQUE ADM PB.						
DESCRIPCION	LARGO (X)	ANCHO (Y)	ALTO (Z)	No.	SUBTOTAL	TOTAL
ESCALERA						
ARER 1	3,45	1,20		1,00	4,14	4,14
AREA 2	2,40	1,20		1,00	2,88	2,88
AREA 3	1,20	1,17		1,00	1,40	1,40
AREA 4	1,70	1,17		1,00	1,99	1,99
AREA 5	2,00	2,15		1,00	4,30	4,30
AREA 6	1,15	2,15		1,00	2,47	2,47
TOTAL						17,18

RESUMEN DE PLANILLA AL 100%					
DESCRIPCION	CONTRATADO	ANTERIOR	ACTUAL	ACUMULADO	UNIDAD
ESTUCADO DE CIELO RASO	212,58	-	17,18	17,18	m2

 CONTRATISTA



 FISCALIZACIÓN

BIEN GOBIERNO AUTÓNOMO DESCENTRALIZADO DE
 PROVINCIA DEL PASTAZA

* CONSTRUCCIÓN DE LOS HANGARES DEL GOBIERNO AUTÓNOMO DESCENTRALIZADO PROVINCIAL DE PASTAZA
 (GADPP2) I ETAPA, PARROQUIA FÁTIMA, CANTÓN Y PROVINCIA DE PASTAZA *

PROYECTO:	182
RUBRO	ESTUCADO DE CIELO RASO
DESCRIPCIÓN	m ²
UNIDAD	1 DE JUNIO 2021 A 30 DE JUNIO 2021
PERIODO	

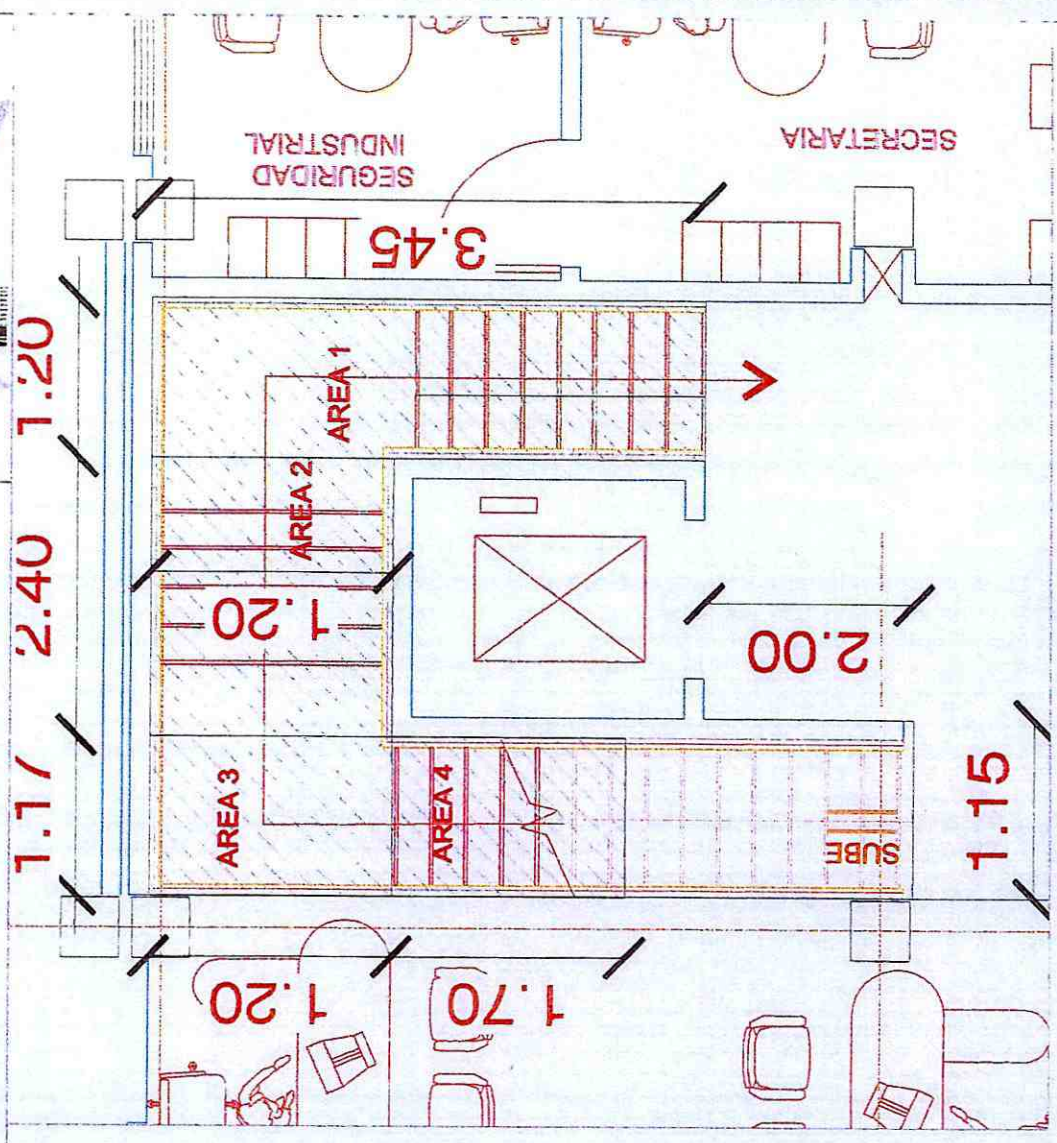
ANEXO: 1



UBICACIÓN: ESCALERA DE BLOQUE ADM

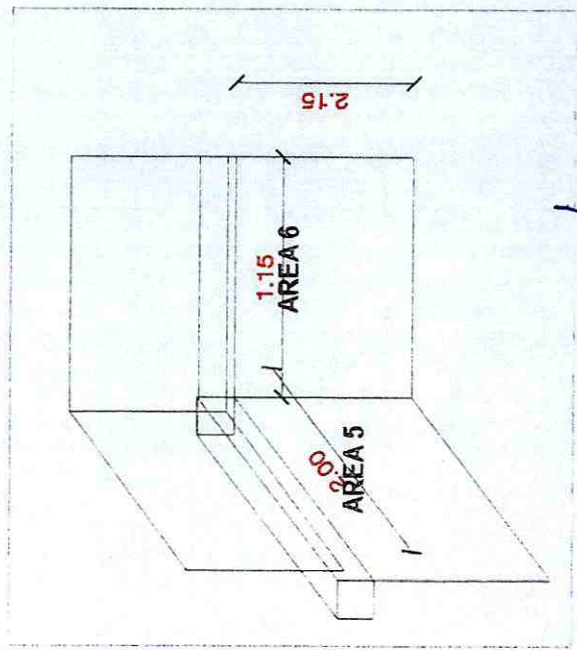

CONTRATISTA

FISCALIZACIÓN

GOBIERNO AUTÓNOMO DESCENTRALIZADO DE LA PROVINCIA DEL PASTAZA

PROYECTO * CONSTRUCCIÓN DE LOS HANGARES DEL GOBIERNO AUTÓNOMO DESCENTRALIZADO PROVINCIAL DE PASTAZA (GADPPz) I ETAPA, PARROQUIA FÁTIMA,
PLANILLA DE AVANCE DE OBRA No. 23

RUBRO N° 185 ANEXO 1
DESCRIPCIÓN: PASAmANOS PARA DISCAPACITADOS TuBO DIAm 32mm E=1.5mm EN ACERO INOXIDABLE AISI 304,
UNIDAD: u
PERIODO: 01-jun 30-jun



PAG. 1 DE 1

PASAmANOS PARA DISCAPACITADOS TuBO DIAm 32mm E=1.5mm EN ACERO INOXIDABLE AISI 304, ACABADO SATINADO (Juego)				
NAVE PRINCIPAL- TALLERES-ADMINISTRATIVO-BODEGA GENERAL				
DESCRIPCION	CANTIDAD	DIMENSION	TOTAL	GRAFICO #
BATERIAS MECANICA LIVIANA PESADA	1,00	-	1,00	ANEXO # 1
TOTAL			1,00	

RESUMEN DE PLANILLA DE INCREMENTOS						
DESCRIPCION	CONTRATADO	ANTERIOR	ACTUAL	INCR. ANT.	INCR. ACT.	UNIDAD
PASAmANOS PARA DISCAPACITADOS TuBO DIAm 32mm E=1.5mm EN ACERO INOXIDABLE AISI 304, ACABADO SATINADO (Juego)	2,00	2,00			1,00	u

CONTRATISTA

FISCALIZACIÓN

BIENIO AUTÓNOMO DESCENTRALIZADO DE LA
PROVINCIA DEL PASTAZA

" CONSTRUCCIÓN DE LOS HANGARES DEL GOBIERNO AUTÓNOMO DESCENTRALIZADO PROVINCIAL DE PASTAZA (GADPPz) I ETAPA, PARROQUIA FÁTIMA, CANTÓN Y PROVINCIA DE PASTAZA "

PROYECTO:

185

PASAMANOS PARA DISCAPACITADOS TUBO DIÁM 32mm E=1.5mm EN ACERO INOXIDABLE AISI 304, ACABADO SATINADO (Juego)

U

01 DE JUNIO 2021 A 30 DE JUNIO 2021

ANEXO: 1

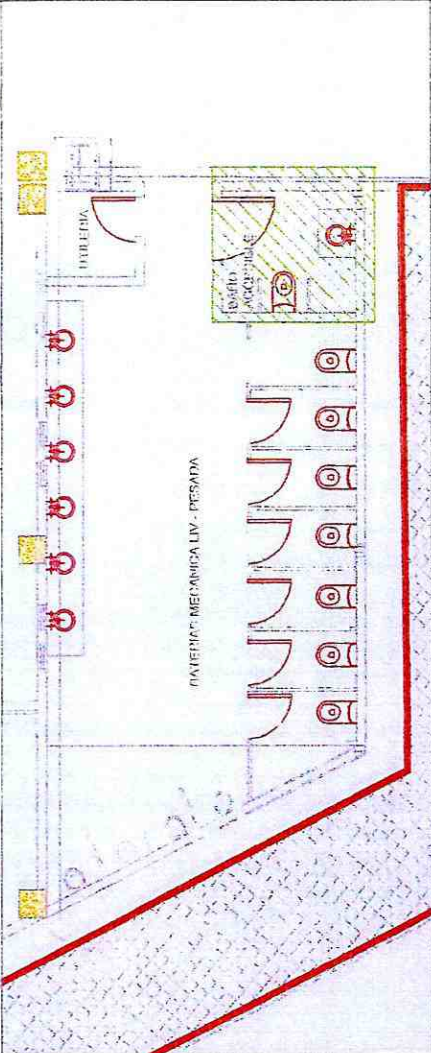
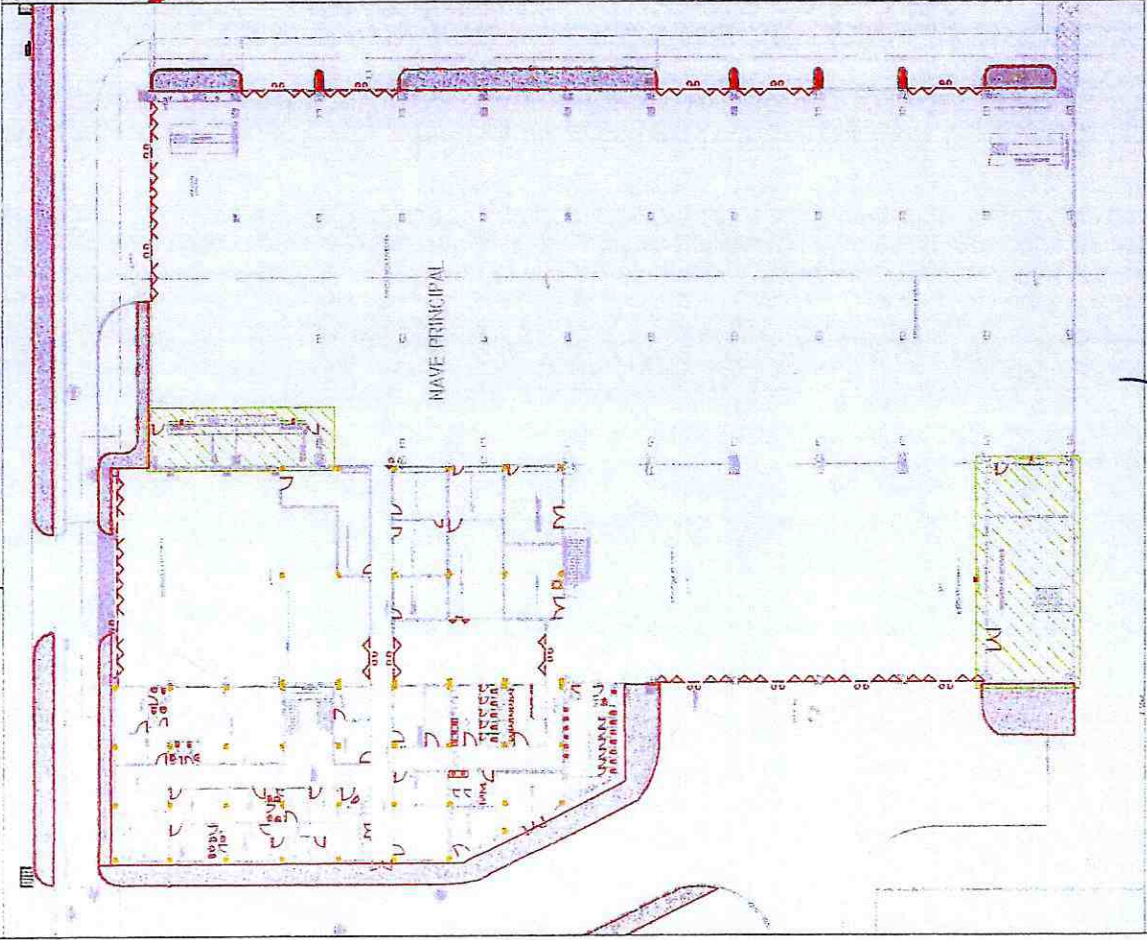

BAÑOS NUEVOS

CONTRATISTA

FISCALIZACIÓN

GOBIERNO AUTÓNOMO DESCENTRALIZADO DE LA PROVINCIA DEL PASTAZA

PROYECTO "CONSTRUCCIÓN DE LOS HANGARES DEL GOBIERNO AUTÓNOMO DESCENTRALIZADO PROVINCIAL DE PASTAZA (GADPPz) I ETAPA, PARROQUIA FÁTIMA, CANTÓN Y PROVINCIA DE PASTAZA "

PLANILLA DE AVANCE DE OBRA No. 20

RUBRO N° 222 ANEXO 1
 DESCRIPCIÓN: PERFIL ESTRUCTURAL ACERO ASTM A (36, 572, 325,193,108) (PROY. MONTAJE GRUA)
 UNIDAD: Kg
 PERIODO: 01-jun 30-jun



NAVE DE LAVADO ENGRASADO

PAG. 1 DE 1

DESCRIPCION	CANTIDAD	DIMENSIONES			PESO ESPECIFICO	SUBTOTAL	UNIDAD
		ESPESOR (m)	DESIGNACION	LONG. (m)			
FACHADA DEL MEDIO DE BODEGA DE ARCHIVO							
MC 122 VERT.	2	0,03	100X100X3	6,33	9,17	116,09	KG
MC 123 VERT.	2	0,03	100X100X3	7,56	9,17	138,65	KG
MC 124 VERT.	1	0,03	100X100X3	9,00	9,17	82,53	KG
MC 125 HORZT.	1	0,03	100X100X3	6,20	9,17	56,85	KG
MC 126 HORZT.	4	0,03	100X100X3	5,57	9,17	204,31	KG
MC 127 HORZT.	1	0,03	100X100X3	4,90	9,17	44,93	KG
MC 128 HORZT.	4	0,03	100X100X3	4,77	9,17	174,96	KG
MC 129 HORZT.	1	0,03	100X100X3	4,90	9,17	44,93	KG
MC 130 HORZT.	4	0,03	100X100X3	4,77	9,17	174,96	KG
MC 131 HORZT.	1	0,03	100X100X3	6,20	9,17	56,85	KG
MC 132 HORZT.	4	0,03	100X100X3	5,57	9,17	204,31	KG
SUBTOTAL 3						1299,37	

RESUMEN DE PLANILLA DE INCREMENTOS

DESCRIPCION	CONTRATADO	ANTERIOR	ACTUAL	INCR. ANT.	INCR. ACT.	UNIDAD
PERFIL ESTRUCTURAL ACERO ASTM A (36, 572, 325,193,108) (PROY. MONTAJE GRUA)	59.540,80	60.309,88			1.299,37	kg

CONTRATISTA

FISCALIZACIÓN

**GOBIERNO AUTONOMO DESCENTRALIZADO DE LA
PROVINCIA DEL PASTAZA**

" CONSTRUCCIÓN DE LOS HANGARES DEL GOBIERNO AUTÓNOMO DESCENTRALIZADO PROVINCIAL DE PASTAZA
(GADPPZ) I ETAPA, PARROQUIA FÁTIMA, CANTÓN Y PROVINCIA DE PASTAZA "

RUBRO 222

DESCRIPCION PERFIL ESTRUCTURAL ACERO ASTM A (36, 572, 325,193,108) (PROY. MONTAJE GRUA)

UNIDAD Kg

PERIODO 1 DE JUNIO 2021 A 30 DE JUNIO 2021

ANEXO: 1

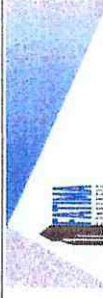

UBICACION - NAVE LAVADO ENGRASADO

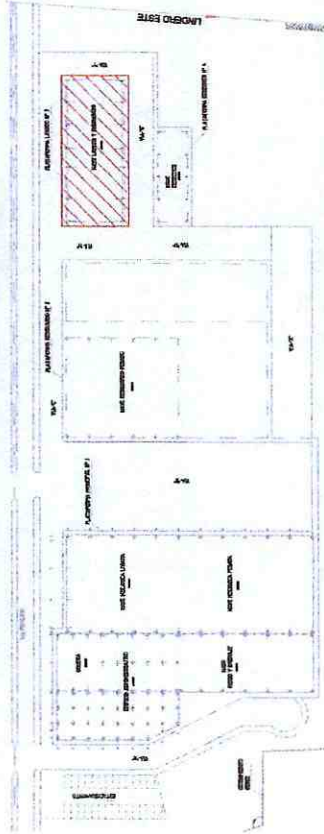

**ESTRUCTURA METALIZAS DE PAREDES DE
PERIMETRALES LAVADO ENGRASADO**

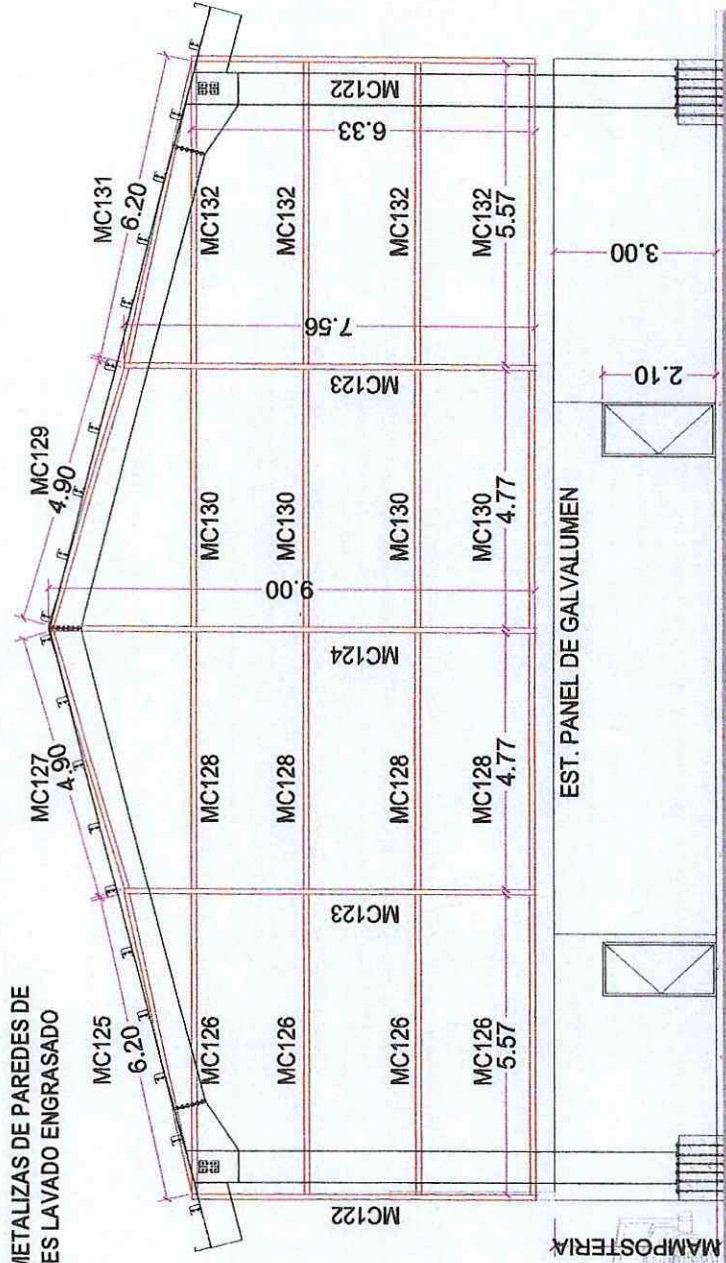

FACHADA FRONTA DE EN MEDIO DE BODEGA

CONTRATISTA

FISCALIZACIÓN

GOBIERNO AUTÓNOMO DESCENTRALIZADO DE LA PROVINCIA DEL PASTAZA

PROYECTO " CONSTRUCCIÓN DE LOS HANGARES DEL GOBIERNO AUTÓNOMO DESCENTRALIZADO PROVINCIAL DE PASTAZA (GADPPz) I ETAPA, PARROQUIA FÁTIMA, CANTÓN Y PROVINCIA DE PASTAZA "

PLANILLA DE AVANCE DE OBRA No. 20

RUBRO N° 223 ANEXO 1
 DESCRIPCIÓN: TRATAMIENTO PINTURA ESTRUCTURA ACERO A36 (FONDO+PINTURA ANTICORROSIVA), A COMPRESOR
 UNIDAD: Kg
 PERIODO: 01-mar 31-mar



NAVE DE LAVADO ENGRASADO

PAG. 1 DE 1

DESCRIPCION	CANTIDAD	DIMENSIONES			PESO ESPECIFICO	SUBTOTAL	UNIDAD
		ESPESOR (m)	DESIGNACION	LONG. (m)			
FACHADA DEL MEDIO DE BODEGA DE ARCHIVO							
MC 122 VERT.	2	0,03	100X100X3	6,33	9,17	116,09	KG
MC 123 VERT.	2	0,03	100X100X3	7,56	9,17	138,65	KG
MC 124 VERT.	1	0,03	100X100X3	9,00	9,17	82,53	KG
MC 125 HORZT.	1	0,03	100X100X3	6,20	9,17	56,85	KG
MC 126 HORZT.	4	0,03	100X100X3	5,57	9,17	204,31	KG
MC 127 HORZT.	1	0,03	100X100X3	4,90	9,17	44,93	KG
MC 128 HORZT.	4	0,03	100X100X3	4,77	9,17	174,96	KG
MC 129 HORZT.	1	0,03	100X100X3	4,90	9,17	44,93	KG
MC 130 HORZT.	4	0,03	100X100X3	4,77	9,17	174,96	KG
MC 131 HORZT.	1	0,03	100X100X3	6,20	9,17	56,85	KG
MC 132 HORZT.	4	0,03	100X100X3	5,57	9,17	204,31	KG
SUBTOTAL 3						1299,37	

RESUMEN DE PLANILLA DE INCREMENTOS

DESCRIPCION	CONTRATADO	ANTERIOR	ACTUAL	INCR. ANT.	INCR. ACT.	UNIDAD
TRATAMIENTO PINTURA ESTRUCTURA ACERO A36 (FONDO+PINTURA ANTICORROSIVA), A COMPRESOR	59.540,80	58.223,16			1.299,37	kg

CONTRATISTA

FISCALIZACIÓN

GOBIERNO AUTONOMO DESCENTRALIZADO DE LA PROVINCIA DEL PASTAZA

" CONSTRUCCIÓN DE LOS HANGARES DEL GOBIERNO AUTÓNOMO DESCENTRALIZADO PROVINCIAL DE PASTAZA (GADPPz) I ETAPA, PARROQUIA FÁTIMA, CANTÓN Y PROVINCIA DE PASTAZA "

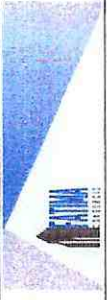

PROYECTO:	ANEXO: 1
RUBRO	223
DESCRIPCION	TRATAMIENTO PINTURA ESTRUCTURA ACERO A38 (FONDO+PINTURA ANTICORROSIVA), A COMPRESOR
UNIDAD	Kg
PERIODO	1 DE JUNIO 2021 A 30 DE JUNIO 2021

UBICACION - NAVE LAVADO ENGRASADO

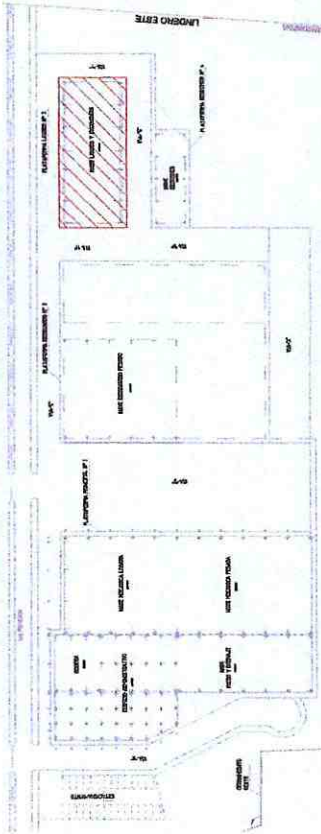

ESTRUCTURA METALIZAS DE PAREDES DE PERIMETRALES LAVADO ENGRASADO

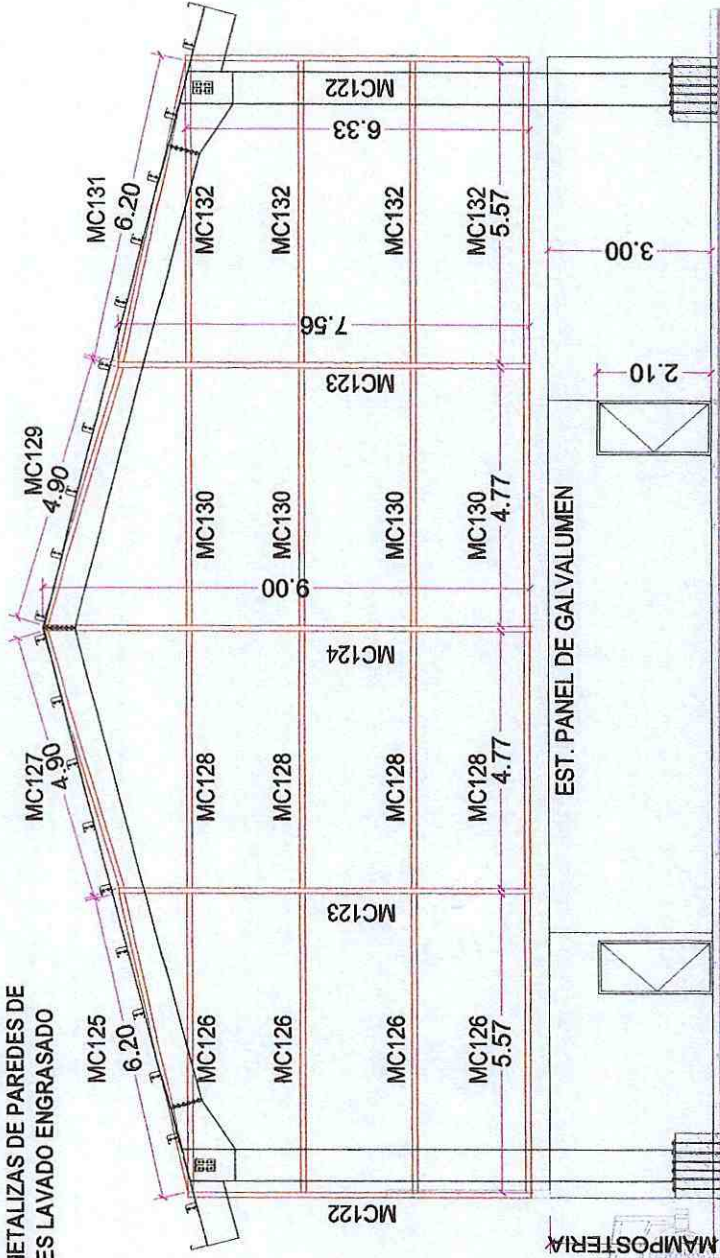

FACHADA FRONTA DE EN MEDIO DE BODEGA

CONTRATISTA

FISCALIZACIÓN

GOBIERNO AUTÓNOMO DESCENTRALIZADO DE LA PROVINCIA DEL PASTAZA

PROYECTO " CONSTRUCCIÓN DE LOS HANGARES DEL GOBIERNO AUTÓNOMO DESCENTRALIZADO PROVINCIAL DE PASTAZA (GADPPz) I ETAPA, PARROQUIA FÁTIMA, CANTÓN Y PLANILLA DE AVANCE DE OBRA No. 23

RUBRO N° 247 ANEXO 1
 DESCRIPCIÓN: mESON H.A. F'C=180 KG/Cm2 E=7 Cm HIERRO (LAVAmANOS+mESON)
 UNIDAD: m
 PERIODO: 01-jun 30-jun



PAG. 1 DE 1

mESON H.A. F'C=180 KG/Cm2 E=7 Cm HIERRO (LAVAmANOS+mESON)						
DESCRIPCION	LARGO (X)	ANCHO (Y)	ALTO (Z)	No.	SUBTOTAL	TOTAL
BANO	3,20			1,00	3,20	3,20

TOTAL		3,20
-------	--	------

RESUMEN DE PLANILLA AL 100%					
DESCRIPCION	CONTRATADO	ANTERIOR	ACTUAL	ACUMULADO	UNIDAD
mESON H.A. F'C=180 KG/Cm2 E=7 Cm HIERRO (LAVAmANOS+mESON)	3,50	-	3,20	3,20	m



 CONTRATISTA



 FISCALIZACIÓN

GOBIERNO AUTÓNOMO DESCENTRALIZADO DE LA PROVINCIA DEL PASTAZA

PROYECTO * CONSTRUCCIÓN DE LOS HANGARES DEL GOBIERNO AUTÓNOMO DESCENTRALIZADO PROVINCIAL DE PASTAZA (GADPPz) I ETAPA, PARROQUIA FÁTIMA, CANTÓN Y PROVINCIA DE PASTAZA *

PLANILLA DE AVANCE DE OBRA No. 23

RUBRO N° 262 ANEXO 1
 DESCRIPCIÓN: PuERTA BATIENTE ALUMINIO Y VIDRIO FLOTADO CLARO 6mm (1.00X2.10)
 UNIDAD: u
 PERIODO: 01-jun 30-jun



PAG. 1 DE 1

PuERTA BATIENTE ALUMINIO Y VIDRIO FLOTADO CLARO 6mm (1.00X2.10)				
NAVE LAVADORA, Y TALLERES CHAPISTERIA-CARPINTERIA				
DESCRIPCION	CANTIDAD	DIMENSION	TOTAL	GRAFICO #
OFICINA BODEGA	1,00	-	1,00	ANEXO # 1
UTILERIA	1,00	-	1,00	ANEXO # 1
OFICINA DE ARCHIVO	1,00	-	1,00	ANEXO # 1
			TOTAL	3,00

RESUMEN DE PLANILLA AL 100%					
DESCRIPCION	CONTRATADO	ANTERIOR	ACTUAL	ACUMULADO	UNIDAD
PuERTA BATIENTE ALUMINIO Y VIDRIO FLOTADO CLARO 6mm (1.00X2.10)	3,00	-	3,00	3,00	u



 CONTRATISTA



 FISCALIZACIÓN

PROYECTO: " CONSTRUCCIÓN DE LOS HANGARES DEL GOBIERNO AUTÓNOMO DESCENTRALIZADO PROVINCIAL DE PASTAZA (GADPPz) I ETAPA, PARROQUIA FÁTIMA, CANTÓN Y PROVINCIA DE PASTAZA "

RUBRO	262	ANEXO:	1
DESCRIPCION	PUERTA BATIENTE ALUMINIO Y VIDRIO FLOTADO CLARO 6mm (1 00X2 10)		
UNIDAD	U		
PERIODO	1 DE JUNIO 2021 A 30 DE JUNIO 2021		



UBICACION - NAVE DE LAVADO ENGRASADO

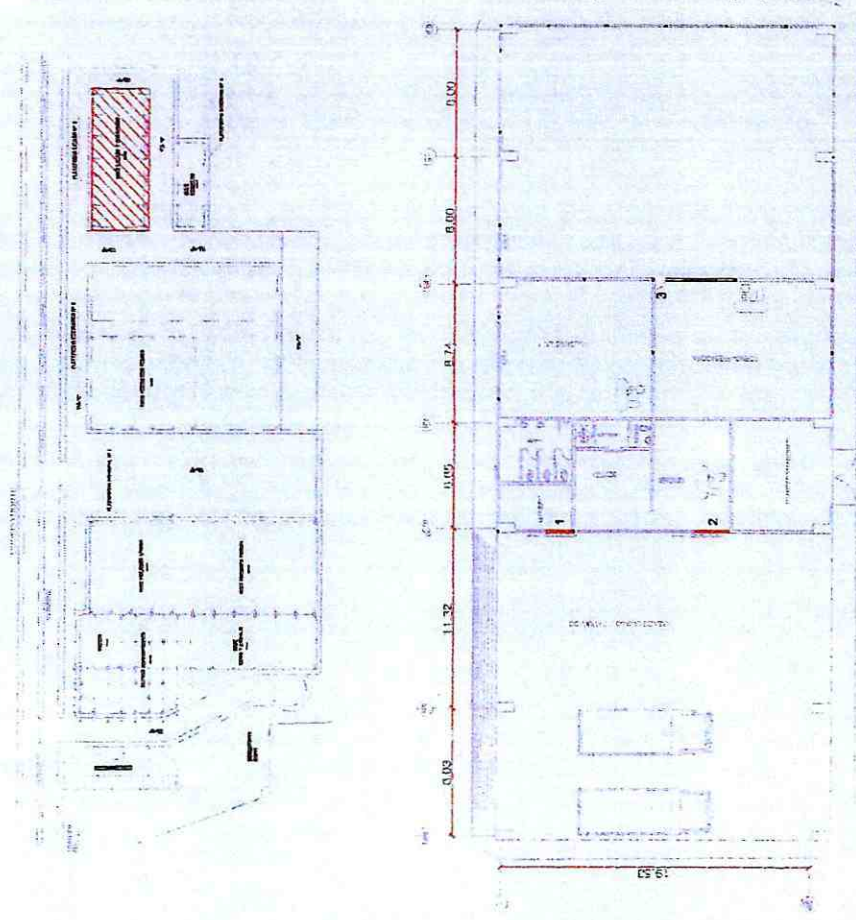

PLANTA ARQUITECTONICA - NAVE LAVADO ENGRASADO

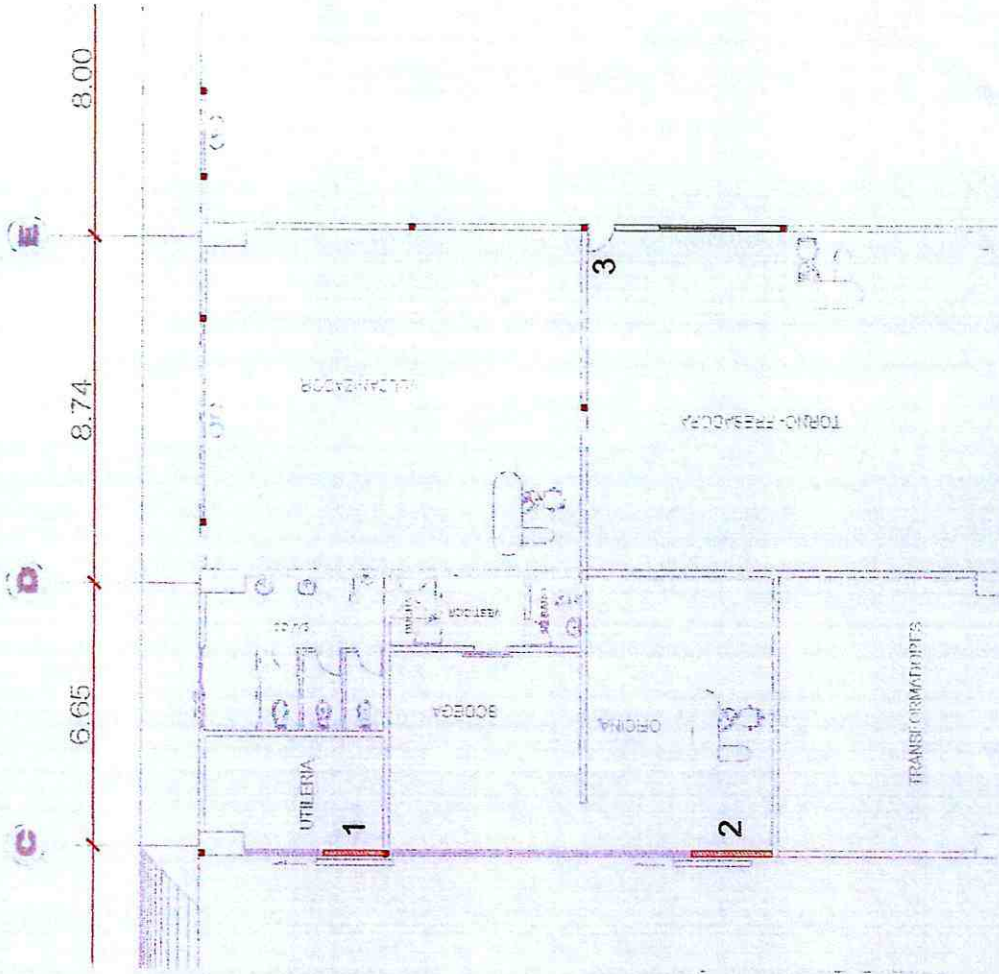

PLANTA ARQUITECTONICA - PUERTA BATIENTE

[Signature]
 CONTRATISTA

[Signature]
 FISCALIZACIÓN

GOBIERNO AUTÓNOMO DESCENTRALIZADO DE LA PROVINCIA DEL PASTAZAS

PROYECTO: " CONSTRUCCIÓN DE LOS HANGARES DEL GOBIERNO AUTÓNOMO DESCENTRALIZADO PROVINCIAL DE PASTAZA (GADPPz) I ETAPA, PARROQUIA FÁTIMA, CANTÓN Y PROVINCIA DE PASTAZA "

PLANILLA DE AVANCE DE OBRA No. 20

RUBRO N°: 263 ANEXO 1
 DESCRIPCIÓN: VENTANA CORREDIZA ALUMINIO SERIE 200-INCL. VIDRIO LAMINADO 6mm
 UNIDAD: m2
 PERIODO: 01-may 31-may



PAG. 1 DE 1

VENTANA CORREDIZA ALUMINIO SERIE 200-INCL. VIDRIO LAMINADO 6mm						
NAVE DE LAVADO						
DESCRIPCION	LARGO (X)	ANCHO (Y)	ALTO (Z)	No.	SUBTOTAL	TOTAL
OFICINA - BODEGA	2,40	0,60		1,00	1,44	1,44
OFICINA - ARCHIVO	2,00	1,05		1,00	2,10	2,10
					TOTAL	3,54

RESUMEN DE PLANILLA AL 100%					
DESCRIPCION	CONTRATADO	ANTERIOR	ACTUAL	ACUMULADO	UNIDAD
VENTANA CORREDIZA ALUMINIO SERIE 200-INCL. VIDRIO LAMINADO 6mm	6,00	-	3,54	3,54	m2



 CONTRATISTA



 FISCALIZACIÓN

BIERNO AUTONOMO DESCENTRALIZADO DE
 PROVINCIA DEL PASTAZA

" CONSTRUCCIÓN DE LOS HANGARES DEL GOBIERNO AUTÓNOMO DESCENTRALIZADO PROVINCIAL DE PASTAZA
 (GADPPZ) I ETAPA, PARROQUIA FÁTIMA, CANTÓN Y PROVINCIA DE PASTAZA "



ANEXO: 1

263 VENTANA CORREDIZA ALUMINIO SERIE 200-INCL. VIDRIO LAMINADO 6mm
 m2
 1 DE JUNIO 2021 A 30 DE JUNIO 2021

PROYECTO:

UBICACION - NAVE DE LAVADO ENGRASADO

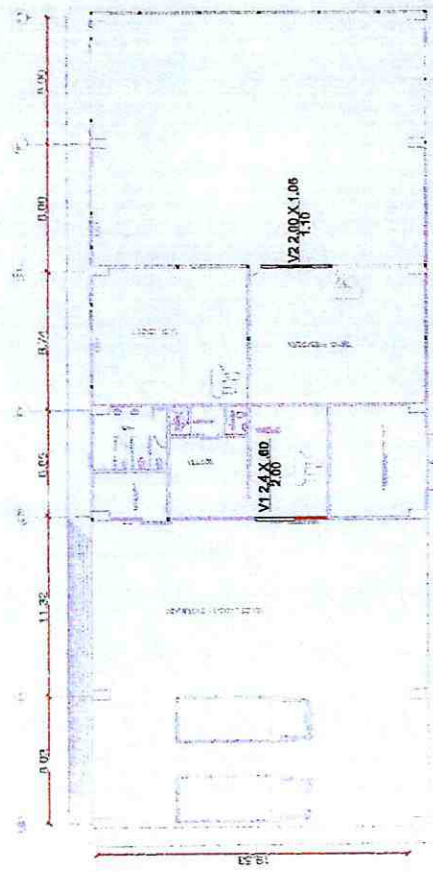
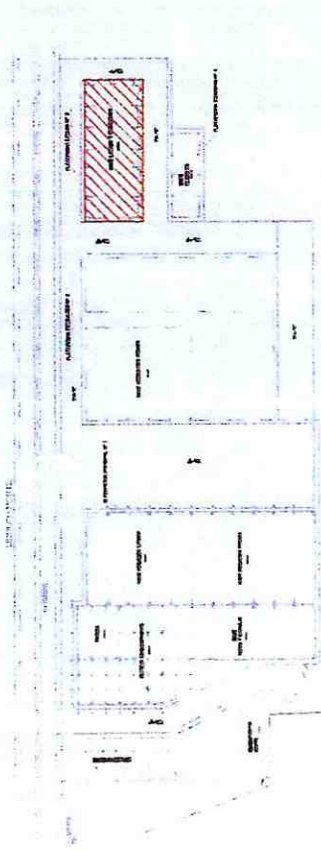

PLANTA ARQUITECTONICA - NAVE LAVADO ENGRASADO

[Signature]
 CONTRATISTA



PLANTA ARQUITECTONICA - PUERTA BATIENTE

[Signature]
 FISCALIZACIÓN

**GOBIERNO AUTÓNOMO DESCENTRALIZADO DE
PROVINCIA DEL PASTAZA**

" CONSTRUCCIÓN DE LOS HANGARES DEL GOBIERNO AUTÓNOMO DESCENTRALIZADO PROVINCIAL DE
PASTAZA (GADPPz) | ETAPA, PARROQUIA FATIMA, CANTÓN Y PROVINCIA DE PASTAZA "



ANEXO: 1

RUBRO	247
DESCRIPCION	mESON H.A. FC=180 KG/Cm2 E=7 Cm HIERRO (LAVAMANOS+mESON)
UNIDAD	m
PERIODO	01 DE JUNIO 2021 A 30 DE JUNIO 2021



LA ZONA GENERAL ARQUITECTONICA DE NAVES

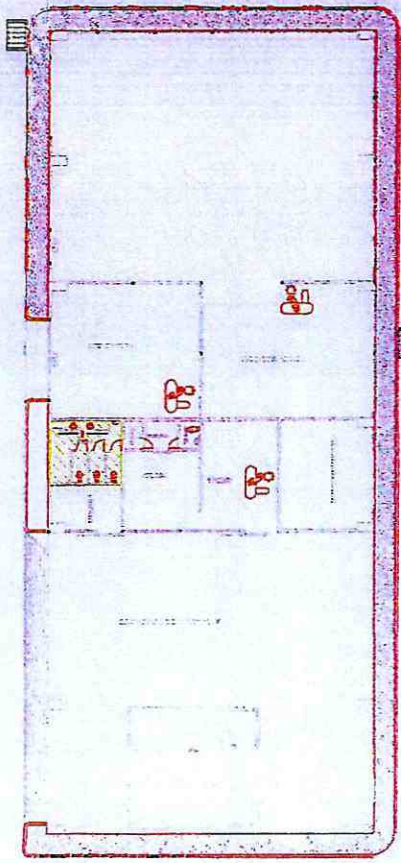
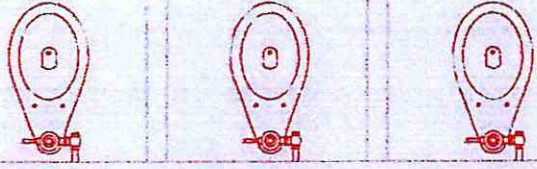
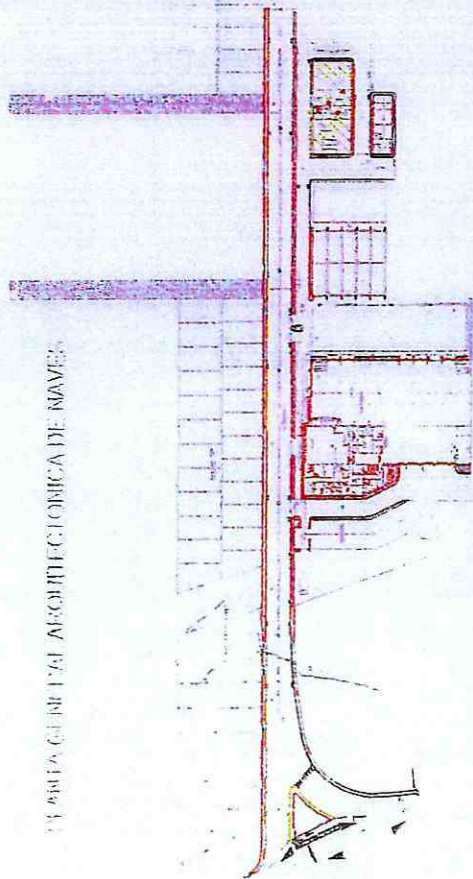

CONTRATISTA

FISCALIZACIÓN

GOBIERNO AUTÓNOMO DESCENTRALIZADO DE LA PROVINCIA DEL PASTAZA

PROYECTO * CONSTRUCCIÓN DE LOS HANGARES DEL GOBIERNO AUTÓNOMO DESCENTRALIZADO PROVINCIAL DE PASTAZA (GADPPz) I ETAPA, PARROQUIA FÁTIMA, CANTÓN Y PLANILLA DE AVANCE DE OBRA No. 23

RUBRO N° 248 ANEXO 1
 DESCRIPCIÓN: REVESTIMIENTO mESON GRANITO
 UNIDAD: m
 PERIODO: 01-jun 30-jun



PAG. 1 DE 1

REVESTIMIENTO mESON GRANITO

DESCRIPCION	LARGO (X)	ANCHO (Y)	ALTO (Z)	No.	SUBTOTAL	TOTAL
BANO	3,20			1,00	3,20	3,20
PATA	0,88			1,00	0,88	0,88

TOTAL		4,08
-------	--	------

RESUMEN DE PLANILLA AL 100%					
DESCRIPCION	CONTRATADO	ANTERIOR	ACTUAL	ACUMULADO	UNIDAD
REVESTIMIENTO mESON GRANITO	3,50	-	3,50	3,50	m

RESUMEN DE PLANILLA DE INCREMENTOS						
DESCRIPCION	CONTRATADO	ANTERIOR	ACTUAL	INCR. ANT.	INCR. ACT.	UNIDAD
REVESTIMIENTO mESON GRANITO	3,50	0,00	0,00	0,00	0,58	m



 CONTRATISTA



 FISCALIZACIÓN

PROYECTO: * CONSTRUCCIÓN DE LOS HANGARES DEL GOBIERNO AUTÓNOMO DESCENTRALIZADO PROVINCIAL DE PASTAZA (GADPPz) | ETAPA, PARROQUIA FÁTIMA, CANTÓN Y PROVINCIA DE PASTAZA *

RUBRO	248
DESCRIPCION	REVESTIMIENTO MESON GRANITO
UNIDAD	m
PERIODO	01 DE JUNIO 2021 A 30 DE JUNIO 2021

ANEXO: 1

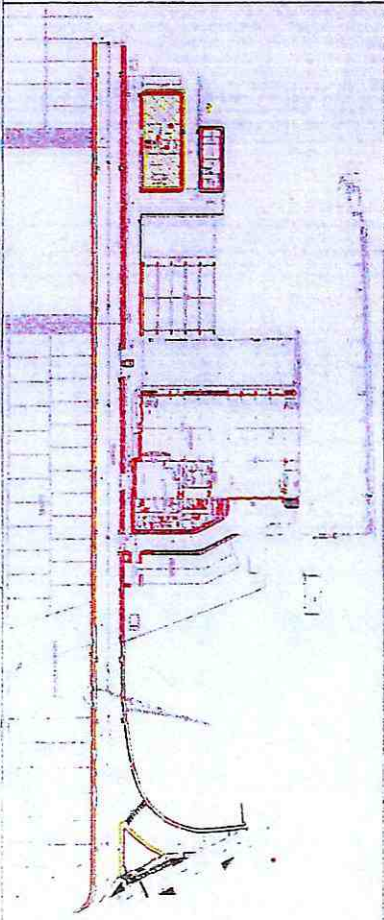

UBICACIÓN: NAVE DE LAVADO

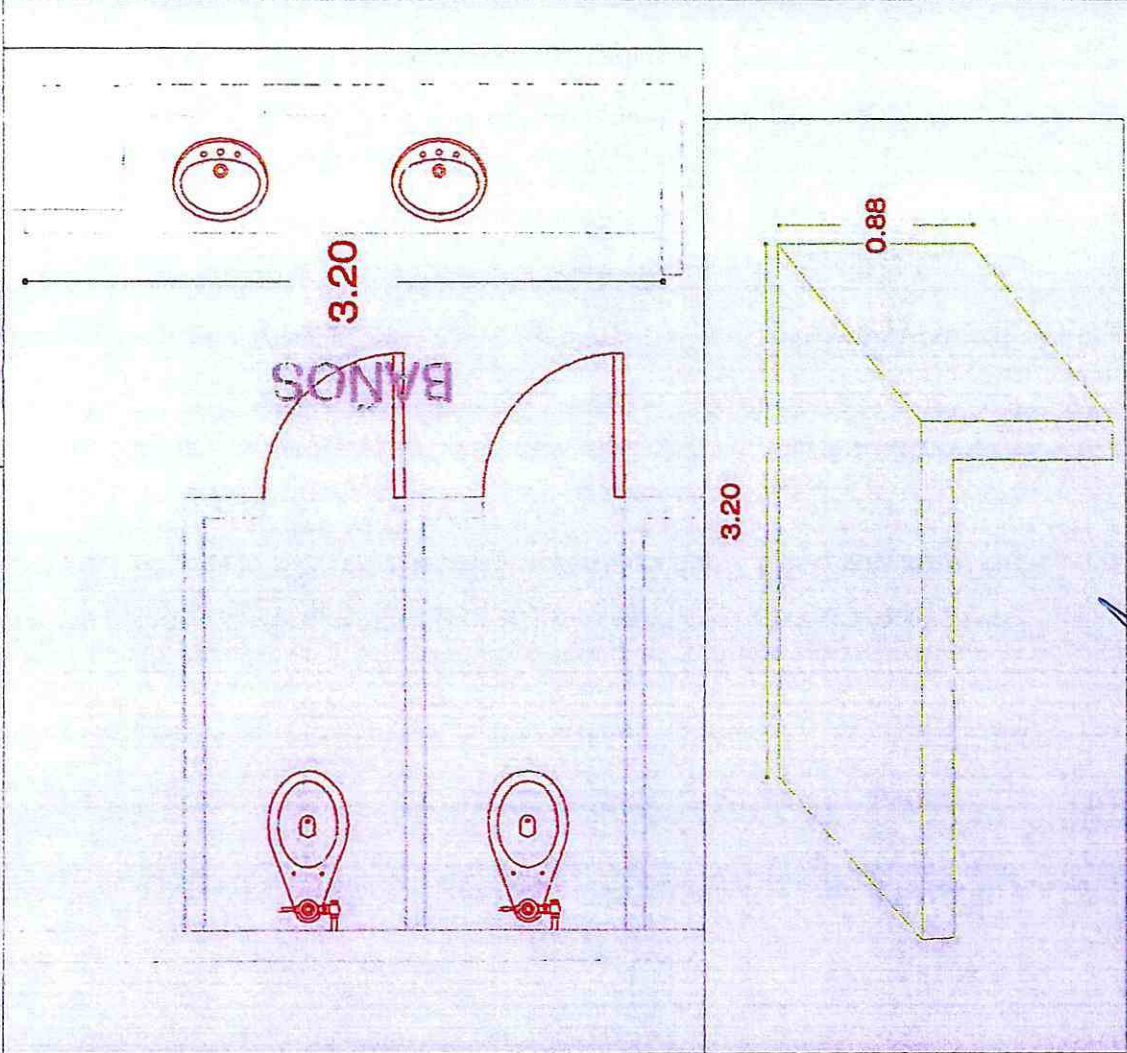

CONTRATISTA

FISCALIZACIÓN

GOBIERNO AUTÓNOMO DESCENTRALIZADO DE LA PROVINCIA DEL PASTAZA

PROYECTO " CONSTRUCCIÓN DE LOS HANGARES DEL GOBIERNO AUTÓNOMO DESCENTRALIZADO PROVINCIAL DE PASTAZA (GADPPz) I ETAPA, PARROQUIA FÁTIMA, CANTÓN Y PROVINCIA DE PASTAZA "

PLANILLA DE AVANCE DE OBRA No. 23

RUBRO N° 262 ANEXO 1
 DESCRIPCIÓN: PuERTA BATIENTE ALUMINIO Y VIDRIO FLOTADO CLARO 6mm (1.00X2.10)
 UNIDAD: u
 PERIODO: 01-jun 30-jun



PAG. 1 DE 1

PuERTA BATIENTE ALUMINIO Y VIDRIO FLOTADO CLARO 6mm (1.00X2.10)				
NAVE LAVADORA, Y TALLERES CHAPISTERIA-CARPINTERIA				
DESCRIPCION	CANTIDAD	DIMENSION	TOTAL	GRAFICO #
OFICINA BODEGA	1,00	-	1,00	ANEXO # 1
UTILERIA	1,00	-	1,00	ANEXO # 1
OFICINA DE ARCHIVO	1,00	-	1,00	ANEXO # 1
TOTAL			3,00	

RESUMEN DE PLANILLA AL 100%					
DESCRIPCION	CONTRATADO	ANTERIOR	ACTUAL	ACUMULADO	UNIDAD
PuERTA BATIENTE ALUMINIO Y VIDRIO FLOTADO CLARO 6mm (1.00X2.10)	3,00	-	3,00	3,00	u



 CONTRATISTA



 FISCALIZACIÓN

PROYECTO: " CONSTRUCCIÓN DE LOS HANGARES DEL GOBIERNO AUTÓNOMO DESCENTRALIZADO PROVINCIAL DE PASTAZA
 (GADPPz) I ETAPA, PARROQUIA FÁTIMA, CANTÓN Y PROVINCIA DE PASTAZA "

RUBRO	282	ANEXO: 1
DESCRIPCION	PUERTA BATIENTE ALUMINIO Y VIDRIO FLOTADO CLARO 6mm (100X210)	
UNIDAD	U	
PERIODO	1 DE JUNIO 2021 A 30 DE JUNIO 2021	



UBICACION - NAVE DE LAVADO ENGRASADO

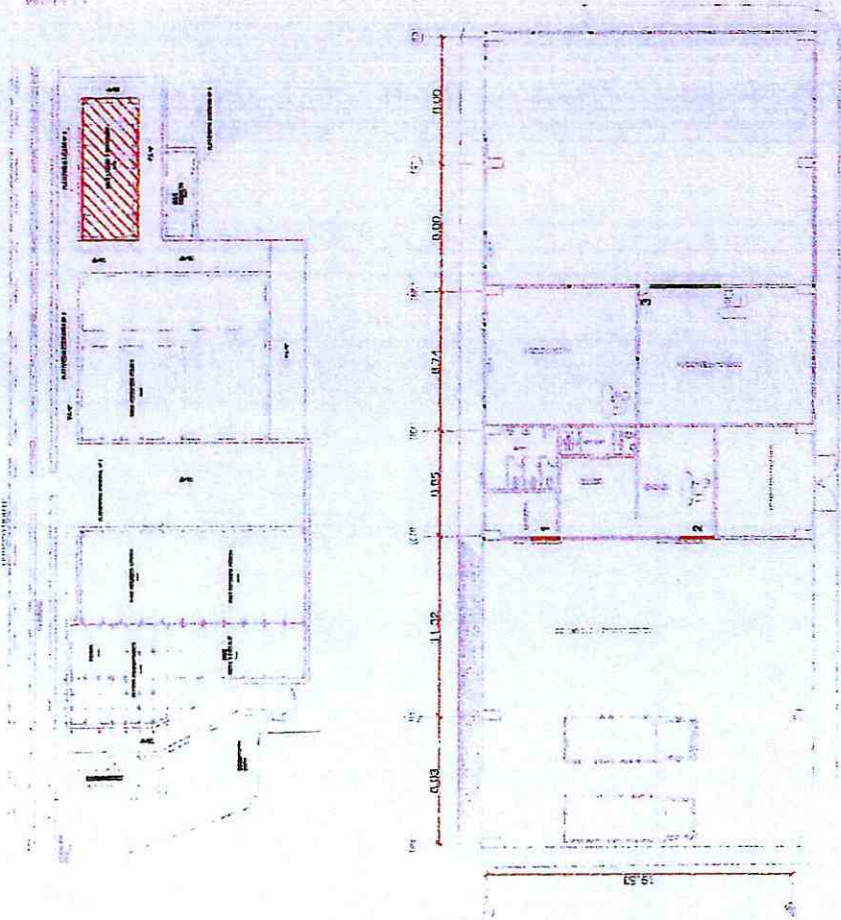

UBICACION - NAVE DE LAVADO ENGRASADO

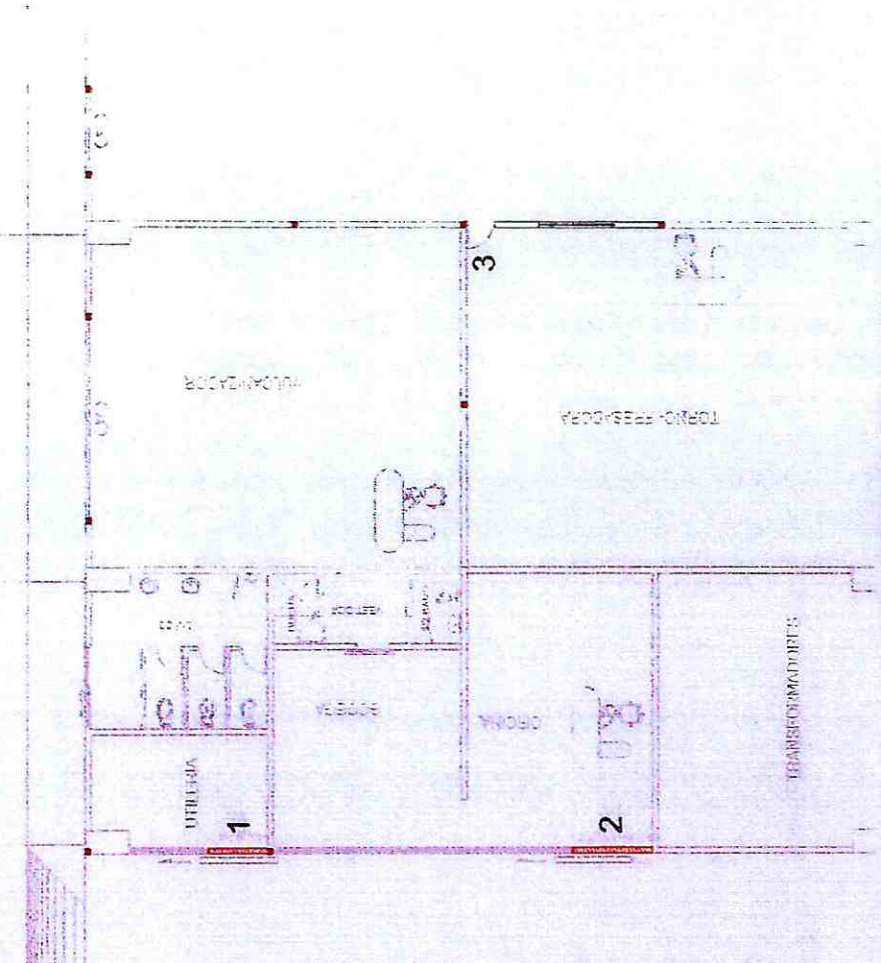

PLANTA ARQUITECTONICA - NAVE LAVADO ENGRASADO

PLANTA ARQUITECTONICA - PUERTA BATIENTE

CONTRATISTA

FISCALIZACIÓN

GOBIERNO AUTÓNOMO DESCENTRALIZADO DE LA PROVINCIA DEL PASTAZAS

PROYECTO " CONSTRUCCIÓN DE LOS HANGARES DEL GOBIERNO AUTÓNOMO DESCENTRALIZADO PROVINCIAL DE PASTAZA (GADPPz) I ETAPA, PARROQUIA FÁTIMA, CANTÓN Y PROVINCIA DE PASTAZA "

PLANILLA DE AVANCE DE OBRA No. 20

RUBRO N° 263 ANEXO 1
 DESCRIPCIÓN: VENTANA CORREDIZA ALUMINIO SERIE 200-INCL VIDRIO LAMINADO 6mm
 UNIDAD: m2
 PERIODO: 01-may 31-may



VENTANA CORREDIZA ALUMINIO SERIE 200-INCL VIDRIO LAMINADO 6mm						
NAVE DE LAVADO						
DESCRIPCION	LARGO (X)	ANCHO (Y)	ALTO (Z)	No.	SUBTOTAL	TOTAL
OFICINA - BODEGA	2,40	0,60		1,00	1,44	1,44
OFICINA - ARCHIVO	2,00	1,05		1,00	2,10	2,10
TOTAL						3,54

RESUMEN DE PLANILLA AL 100%					
DESCRIPCION	CONTRATADO	ANTERIOR	ACTUAL	ACUMULADO	UNIDAD
VENTANA CORREDIZA ALUMINIO SERIE 200-INCL VIDRIO LAMINADO 6mm	6,00	-	3,54	3,54	m2



 CONTRATISTA



 FISCALIZACIÓN

**BIERNO AUTONOMO DESCENTRALIZADO DE
PROVINCIA DEL PASTAZA**

* CONSTRUCCIÓN DE LOS HANGARES DEL GOBIERNO AUTÓNOMO DESCENTRALIZADO PROVINCIAL DE PASTAZA
(GADPPz) I ETAPA, PARROQUIA FÁTIMA, CANTÓN Y PROVINCIA DE PASTAZA *

PROYECTO:	ANEXO: 1		
RUBRO	283		
DESCRIPCIÓN	VENTANA CORREDIZA ALUMINIO SERIE 200-INCL. VIDRIO LAMINADO 6mm		
UNIDAD	m ²		
PERIODO	1 DE JUNIO 2021 A 30 DE JUNIO 2021		



UBICACION - NAVE DE LAVADO ENGRASADO

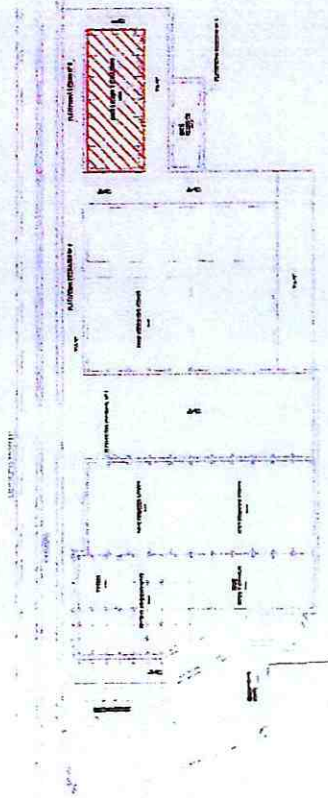

PLANTA ARQUITECTONICA - NAVE LAVADO ENGRASADO

[Signature]
CONTRATISTA

UBICACION - NAVE DE LAVADO ENGRASADO

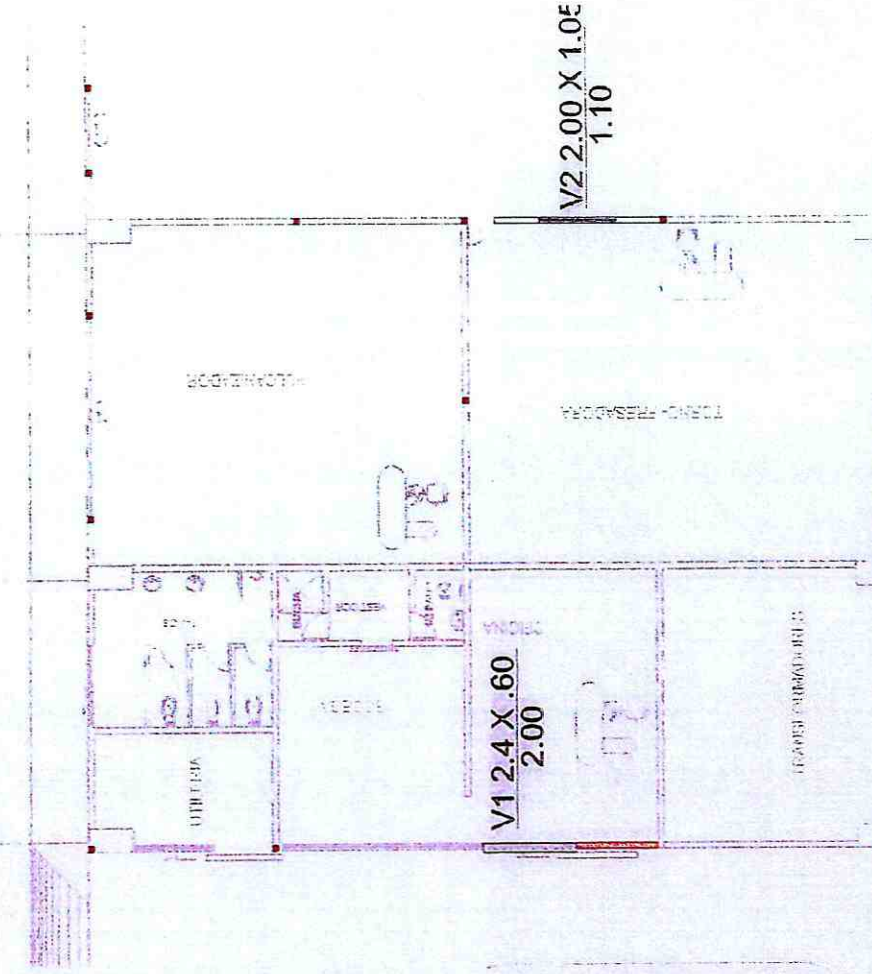

PLANTA ARQUITECTONICA - PUERTA BATIENDE

[Signature]
FISCALIZACIÓN

GOBIERNO AUTÓNOMO DESCENTRALIZADO DE LA PROVINCIA DEL PASTAZA

PROYECTO " CONSTRUCCIÓN DE LOS HANGARES DEL GOBIERNO AUTÓNOMO DESCENTRALIZADO PROVINCIAL DE PASTAZA (GADPP2) I ETAPA, PARROQUIA FÁTIMA, CANTÓN Y PROVINCIA DE PASTAZA "

PLANILLA DE AVANCE DE OBRA No. 23

RUBRO N° 271 ANEXO 1
 DESCRIPCIÓN: DISPENSOR DE PAPEL HIGIENICO DIAm=275mm, ROLLO 70mm, ABATIBLE,ACERO INOX E=8mm, AISI 304.
 UNIDAD: u
 PERIODO: 01-jun 30-jun



PAG. 1 DE 1

DISPENSOR DE PAPEL HIGIENICO DIAm=275mm, ROLLO 70mm, ABATIBLE,ACERO INOX E=8mm, AISI 304. ACABADO S				
NAVE LAVADORA, Y TALLERES CHAPISTERIA-CARPINTERIA				
DESCRIPCION	CANTIDAD	DIMENSION	TOTAL	GRAFICO #
BAÑOS	3,00	-	3,00	ANEXO # 1
			TOTAL	3,00

RESUMEN DE PLANILLA AL 100%					
DESCRIPCION	CONTRATADO	ANTERIOR	ACTUAL	ACUMULADO	UNIDAD
DISPENSOR DE PAPEL HIGIENICO DIAm=275mm, ROLLO 70mm, ABATIBLE,ACERO INOX E=8mm, AISI 304. ACABADO S	3,00	-	3,00	3,00	u



 CONTRATISTA



 FISCALIZACIÓN

" CONSTRUCCIÓN DE LOS HANGARES DEL GOBIERNO AUTÓNOMO DESCENTRALIZADO PROVINCIAL DE PASTAZA
 (GADPPz) I ETAPA, PARROQUIA FÁTIMA, CANTÓN Y PROVINCIA DE PASTAZA "

PROYECTO:	
RUBRO	271
DESCRIPCION	DISPENSOR DE PAPEL HIGIENICO DIAM=275mm, ROLLO 70mm, ABATIBLE, ACERO INOX E=8mm, AISI 304, ACABADO S
UNIDAD	U
PERIODO	1 DE JUNIO 2021 A 30 DE JUNIO 2021



ANEXO: 1

UBICACION - NAVE DE LAVADO ENGRASADO

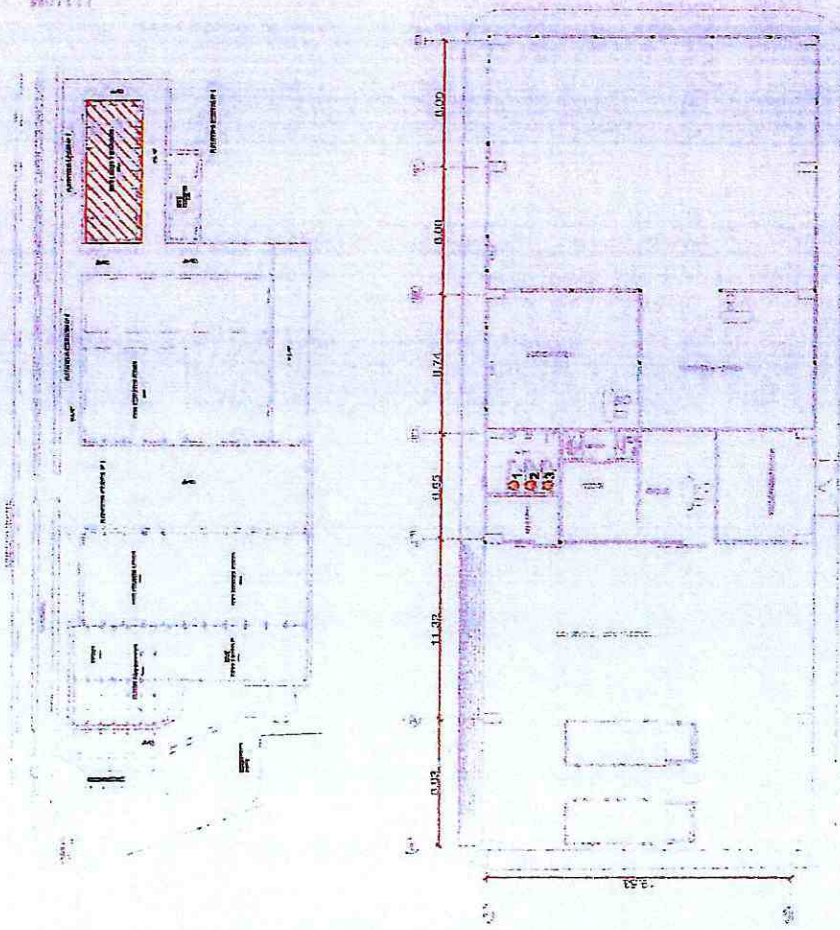

PLANTA ARQUITECTONICA - NAVE LAVADO ENGRASADO

UBICACION - NAVE DE TRANSFORMADORES

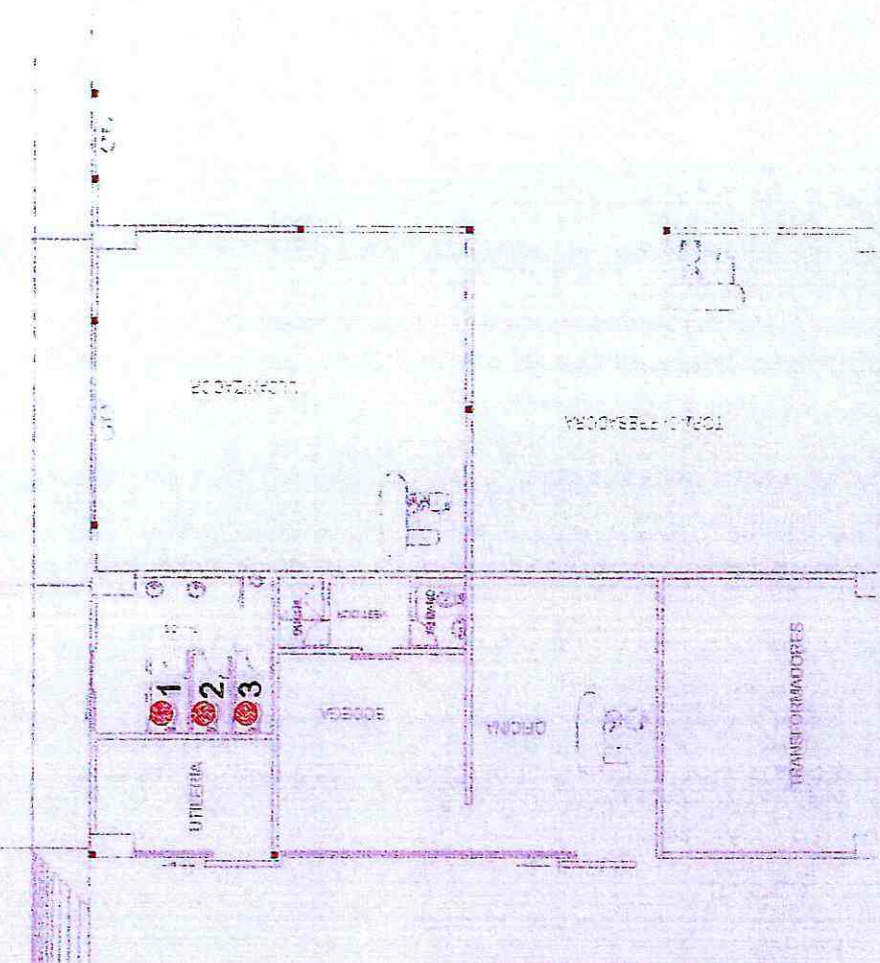

PLANTA ARQUITECTONICA - DISPENSADOR PAPEL HIGIENICO

[Signature]
 CONTRATISTA

[Signature]
 FISCALIZACION

GOBIERNO AUTÓNOMO DESCENTRALIZADO DE LA PROVINCIA DEL PASTAZA

PROYECTO * CONSTRUCCIÓN DE LOS HANGARES DEL GOBIERNO AUTÓNOMO DESCENTRALIZADO PROVINCIAL DE PASTAZA (GADPPPz) I ETAPA, PARROQUIA FÁTIMA, CANTÓN Y PROVINCIA DE PASTAZA *
 PLANILLA DE AVANCE DE OBRA No. 23

RUBRO N° 272 ANEXO 1
 DESCRIPCIÓN: DISPENSOR DE PAPEL TOALLA 400-600 UNIDADES, 330X273X130mm, ACERO INOX E=8mm AISI 304,
 UNIDAD: u
 PERIODO: 01-jun 30-jun



PAG. 1 DE 1

DISPENSOR DE PAPEL TOALLA 400-600 UNIDADES, 330X273X130mm, ACERO INOX E=8mm AISI 304, ACABADO SATINAD				
NAVE LAVADORA, Y TALLERES CHAMISTERIA-CARPINTERIA				
DESCRIPCION	CANTIDAD	DIMENSION	TOTAL	GRAFICO #
BAÑOS	1,00	-	1,00	ANEXO # 1
1/2 BAÑO	1,00	-	1,00	ANEXO # 1
			TOTAL	2,00

RESUMEN DE PLANILLA AL 100%					
DESCRIPCION	CONTRATADO	ANTERIOR	ACTUAL	ACUMULADO	UNIDAD
DISPENSOR DE PAPEL TOALLA 400-600 UNIDADES, 330X273X130mm, ACERO INOX E=8mm AISI 304, ACABADO SATINAD	2,00	-	2,00	2,00	u



 CONTRATISTA



 FISCALIZACIÓN

**GOBIERNO AUTONOMO DESCENTRALIZADO DE
PROVINCIA DEL PASTAZA**

" CONSTRUCCIÓN DE LOS HANGARES DEL GOBIERNO AUTÓNOMO DESCENTRALIZADO PROVINCIAL DE PASTAZA
(GADPPz) | ETAPA, PARROQUIA FÁTIMA, CANTÓN Y PROVINCIA DE PASTAZA "

272

DISPENSOR DE PAPEL TOALLA 400-600 UNIDADES, 330X273X130mm, ACERO INOX E=8mm AISI 304, ACABADO SATINAD
U

1 DE JUNIO 2021 A 30 DE JUNIO 2021

ANEXO: 1



PROYECTO:

RUBRO
DESCRIPCION
UNIDAD
PERIODO

UBICACION - NAVE DE LAVADO ENGRASADO

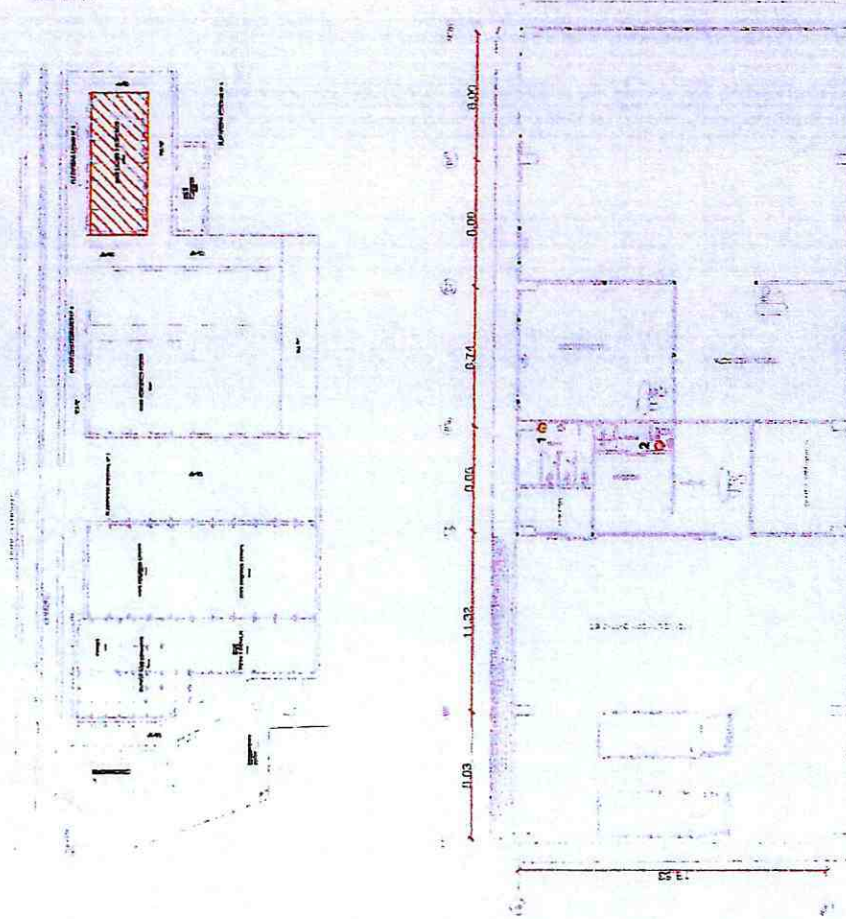

PLANTA ARQUITECTONICA - NAVE LAVADO ENGRASADO

UBICACION - NAVE DE LAVADO ENGRASADO

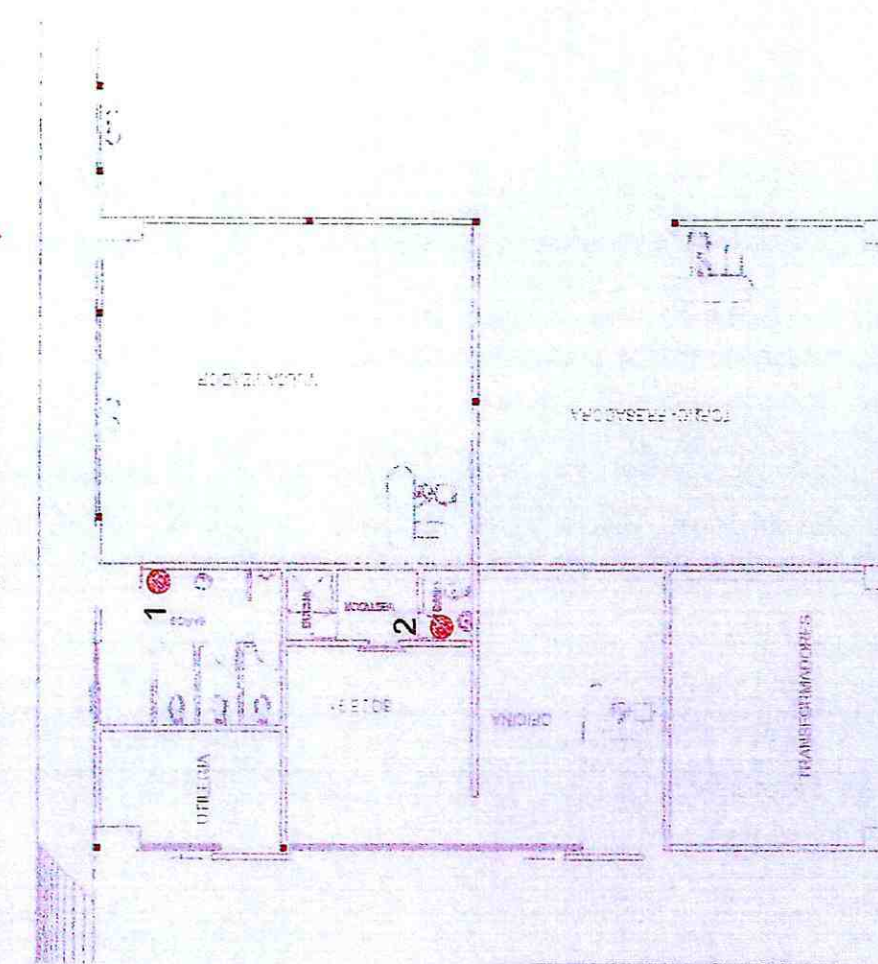

PLANTA ARQUITECTONICA - DISPENSADOR DE PAPEL

[Signature]
CONTRATISTA

[Signature]
FISCALIZACIÓN

GOBIERNO AUTÓNOMO DESCENTRALIZADO DE LA PROVINCIA DEL PASTAZA

PROYECTO " CONSTRUCCIÓN DE LOS HANGARES DEL GOBIERNO AUTÓNOMO DESCENTRALIZADO PROVINCIAL DE PASTAZA (GADPPz) I ETAPA, PARROQUIA FÁTIMA, CANTÓN Y PROVINCIA DE PASTAZA "

PLANILLA DE AVANCE DE OBRA No. 20

RUBRO N° 273 ANEXO 1
 DESCRIPCIÓN: DISPENSADOR DE JABON LIQUIDO ACERO INOX AISI304, ACABADO SATINADO
 UNIDAD: u
 PERIODO: 01-jun 30-jun



PAG. 1 DE 1

DISPENSADOR DE JABON LIQUIDO ACERO INOX AISI304, ACABADO SATINADO				
NAVE LAVADORA, Y TALLERES CHAPISTERIA-CARPINTERIA				
DESCRIPCION	CANTIDAD	DIMENSION	TOTAL	GRAFICO #
BAÑOS	1,00	-	1,00	ANEXO # 1
1/2 BAÑO	1,00	-	1,00	ANEXO # 1
			TOTAL	2,00

RESUMEN DE PLANILLA AL 100%					
DESCRIPCION	CONTRATADO ANTERIOR	ACTUAL	ACUMULADO	UNIDAD	
DISPENSADOR DE JABON LIQUIDO ACERO INOX AISI304, ACABADO SATINADO	2,00	-	2,00	2,00	u

 CONTRATISTA



 FISCALIZACIÓN

"CONSTRUCCIÓN DE LOS HANGARES DEL GOBIERNO AUTÓNOMO DESCENTRALIZADO PROVINCIAL DE PASTAZA (GADPPz) | ETAPA, PARROQUIA FÁTIMA, CANTÓN Y PROVINCIA DE PASTAZA "

RUBRO	273
DESCRIPCION	DISPENSADOR DE JABON LIQUIDO ACERO INOX AISI304, ACABADO SATINADO
UNIDAD	U
PERIODO	1 DE JUNIO 2021 A 30 DE JUNIO 2021

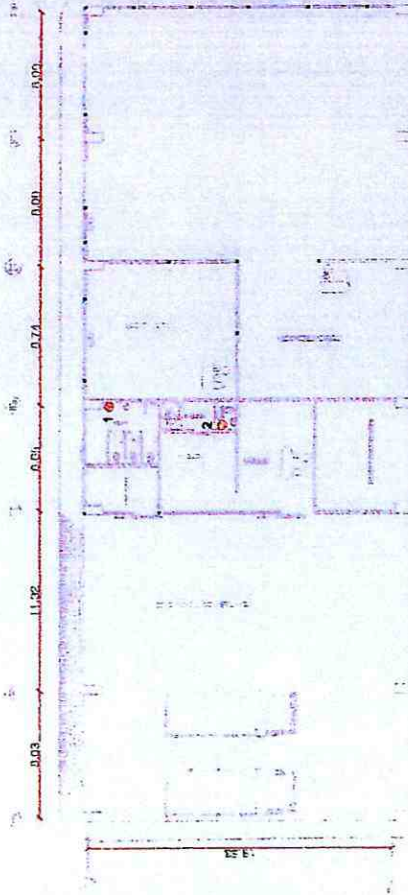
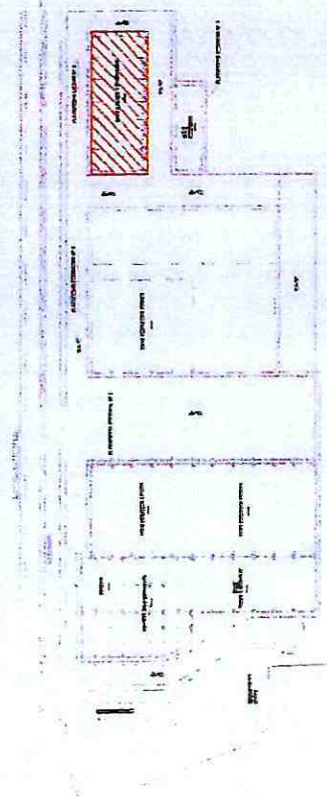

UBICACION - NAVE DE LAVADO ENGRASADO



PLANTA ARQUITECTÓNICA - NAVE LAVADO ENGRASADO

CONTRATISTA

UBICACION - NAVE DE LAVADO LIQUIDO

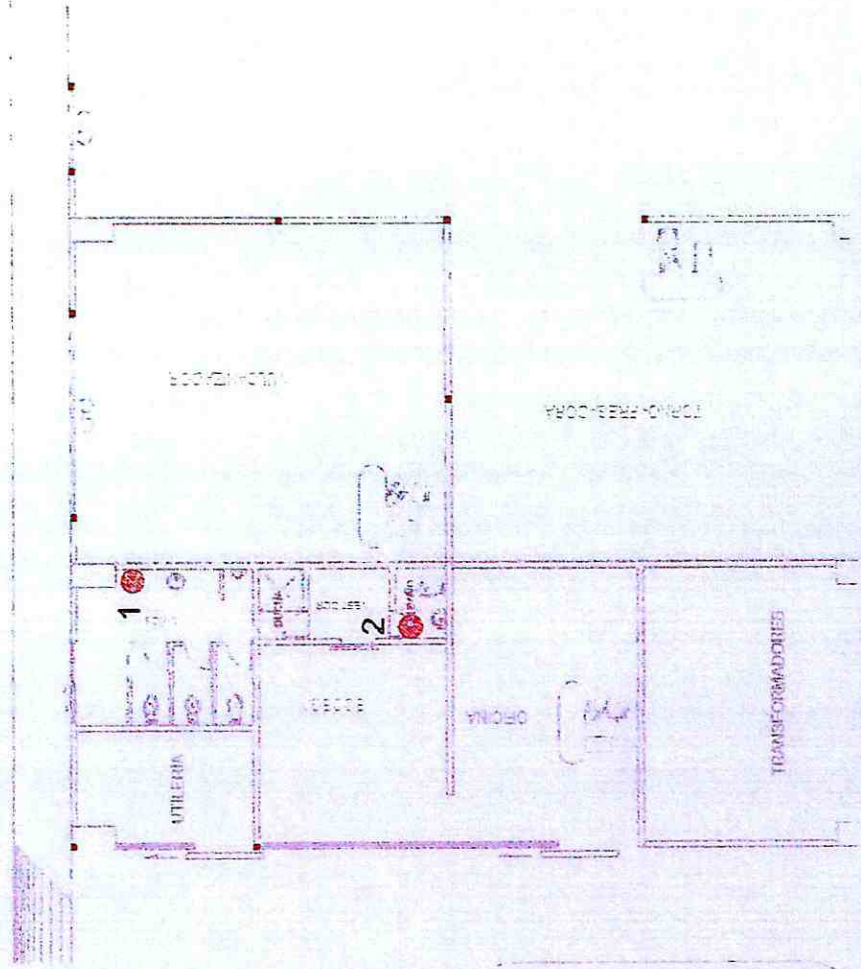

PLANTA ARQUITECTÓNICA - DISPENSADOR DE JABON LIQUIDO

FISCALIZACIÓN

PROYECTO " CONSTRUCCIÓN DE LOS HANGARES DEL GOBIERNO AUTÓNOMO DESCENTRALIZADO PROVINCIAL DE PASTAZA (GADPPZ) I ETAPA, PARROQUIA FÁTIMA, CANTÓN Y PROVINCIA DE PASTAZA "

PLANILLA DE AVANCE DE OBRA No. 23

RUBRO N° 274
 DESCRIPCIÓN: ESPEJO DE VIDRIO FLOTADO 4mm- mARCO DE ALUMINIO
 UNIDAD: m2
 PERIODO: 01-jun 30-jun

ANEXO 1



PAG. 1 DE 1

ESPEJO DE VIDRIO FLOTADO 4mm- mARCO DE ALUMINIO						
NAVE LAVADORA, Y TALLERES CHAPISTERIA-CARPINTERIA						
DESCRIPCION	LARGO (X)	ANCHO (Y)	ALTO (Z)	No.	SUBTOTAL	TOTAL
A1	2,60		0,80	1,00	2,08	2,08
A2	0,80		0,80	1,00	0,64	0,64
					TOTAL	2,72

2,70

RESUMEN DE PLANILLA AL 100%					
DESCRIPCION	CONTRATADO	ANTERIOR	ACTUAL	ACUMULADO	UNIDAD
ESPEJO DE VIDRIO FLOTADO 4mm- mARCO DE ALUMINIO	2,70	-	2,72	2,72	m2



 CONTRATISTA



 FISCALIZACIÓN

" CONSTRUCCIÓN DE LOS HANGARES DEL GOBIERNO AUTÓNOMO DESCENTRALIZADO PROVINCIAL DE PASTAZA
 (GADPPZ) I ETAPA, PARROQUIA FATIMA, CANTÓN Y PROVINCIA DE PASTAZA "



RUBRO	274	ANEXO: 1
DESCRIPCION	ESPEJO DE VIDRIO FLOTADO 4mm- marco de ALUMINIO	
UNIDAD	m ²	
PERIODO	1 DE JUNIO 2021 A 30 DE JUNIO 2021	

PROYECTO:

UBICACION - NAVE DE LAVADO ENGRASADO

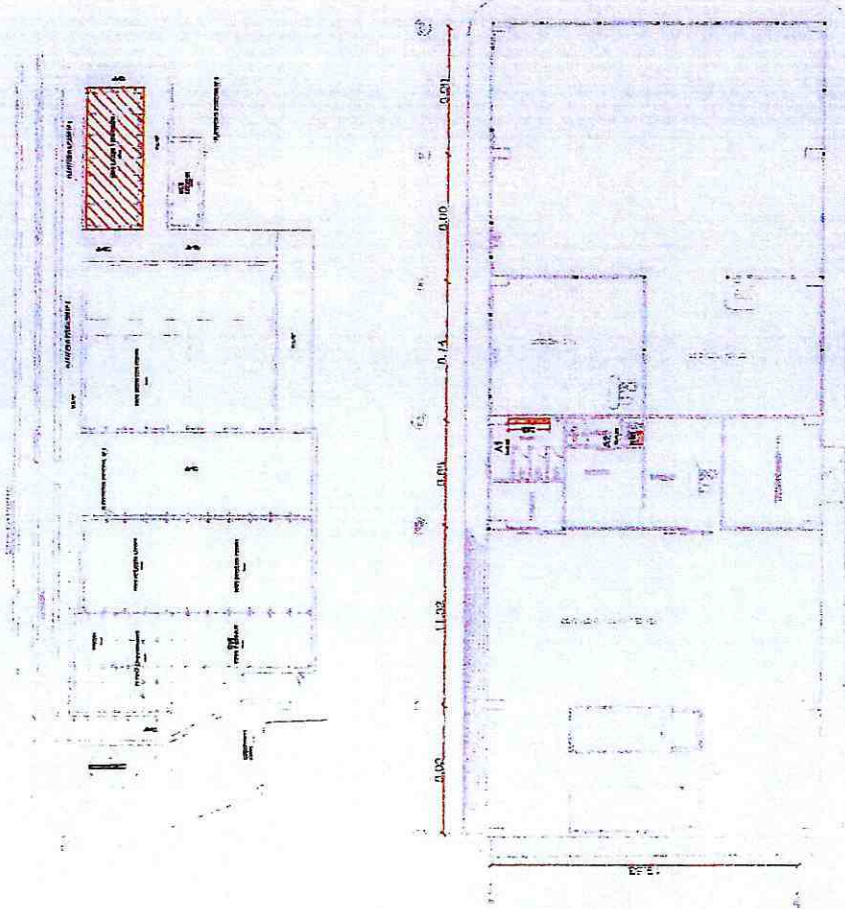

PLANTA ARQUITECTONICA - NAVE LAVADO ENGRASADO

CONTRATISTA

UBICACION - ESPEJO DE VIDRIO

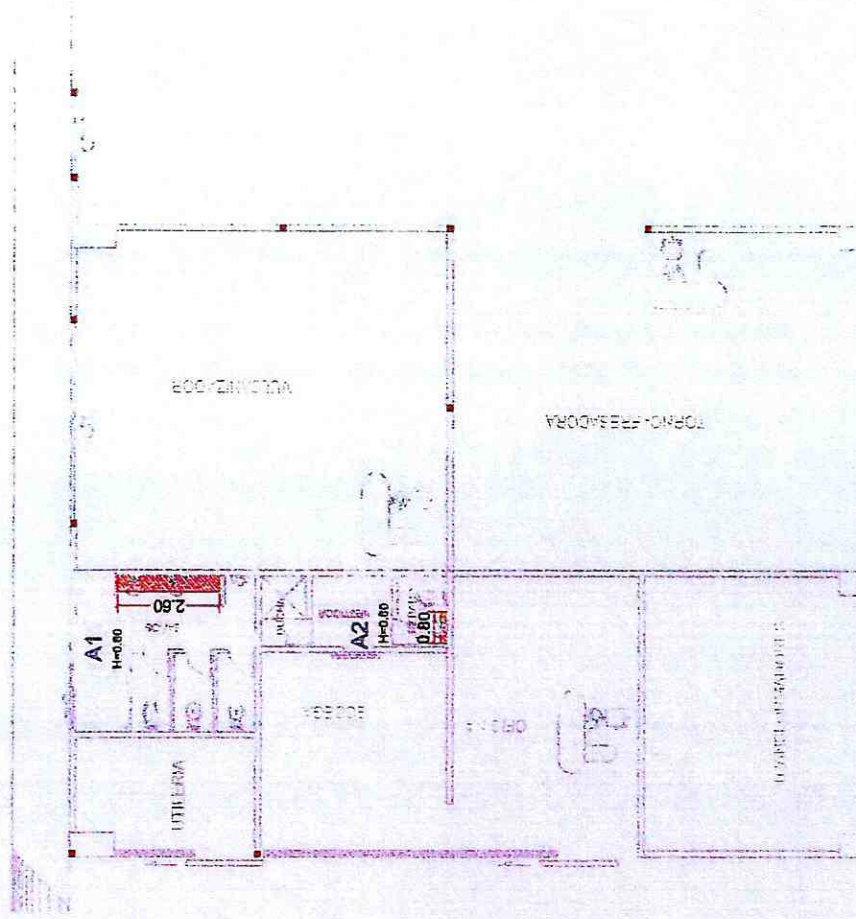

PLANTA ARQUITECTONICA - ESPEJO DE VIDRIO

FISCALIZACIÓN

GOBIERNO AUTÓNOMO DESCENTRALIZADO DE LA PROVINCIA DEL PASTAZA

PROYECTO * CONSTRUCCIÓN DE LOS HANGARES DEL GOBIERNO AUTÓNOMO DESCENTRALIZADO PROVINCIAL DE PASTAZA (GADPPz) I ETAPA, PARROQUIA FÁTIMA, CARTÓN Y PROVINCIA DE PASTAZA *

PLANILLA DE AVANCE DE OBRA No. 23

RUBRO N° 275 ANEXO 1
 DESCRIPCIÓN: SECADOR DE MANOS ACCIONAMIENTO AUTOMÁTICO 260X302X150mm, ACERO INOX. 304,
 UNIDAD: u
 PERIODO: 01-jun 30-jun



PAG. 1 DE 1

SECADOR DE MANOS ACCIONAMIENTO AUTOMÁTICO 260X302X150mm, ACERO INOX. 304, LAMINA 1.5mm 110V-60HZ				
NAVE LAVADORA, Y TALLERES CHAPISTERIA-CARPINTERIA				
DESCRIPCION	CANTIDAD	DIMENSION	TOTAL	GRAFICO #
BAÑOS	1,00	-	1,00	ANEXO # 1
1/2 BAÑO	1,00	-	1,00	ANEXO # 1
TOTAL			2,00	

2.00

RESUMEN DE PLANILLA AL 100%					
DESCRIPCION	CONTRATADO	ANTERIOR	ACTUAL	ACUMULADO	UNIDAD
SECADOR DE MANOS ACCIONAMIENTO AUTOMÁTICO 260X302X150mm, ACERO INOX. 304, LAMINA 1.5mm 110V-60HZ	2,00	-	2,00	2,00	u

CONTRATISTA

FISCALIZACIÓN

" CONSTRUCCIÓN DE LOS HANGARES DEL GOBIERNO AUTÓNOMO DESCENTRALIZADO PROVINCIAL DE PASTAZA
(GADPPz) | ETAPA, PARROQUIA FÁTIMA, CANTÓN Y PROVINCIA DE PASTAZA "

RUBRO	275	ANEXO: 1
DESCRIPCION	SECADOR DE MANOS ACCIONAMIENTO AUTOMÁTICO 260X302X150mm, ACERO INOX. 304, LAMINA 1.5mm 110V-60HZ	
UNIDAD	U	
PERIODO	1 DE JUNIO 2021 A 30 DE JUNIO 2021	



UBICACION - NAVE DE LAVADO ENGRASADO

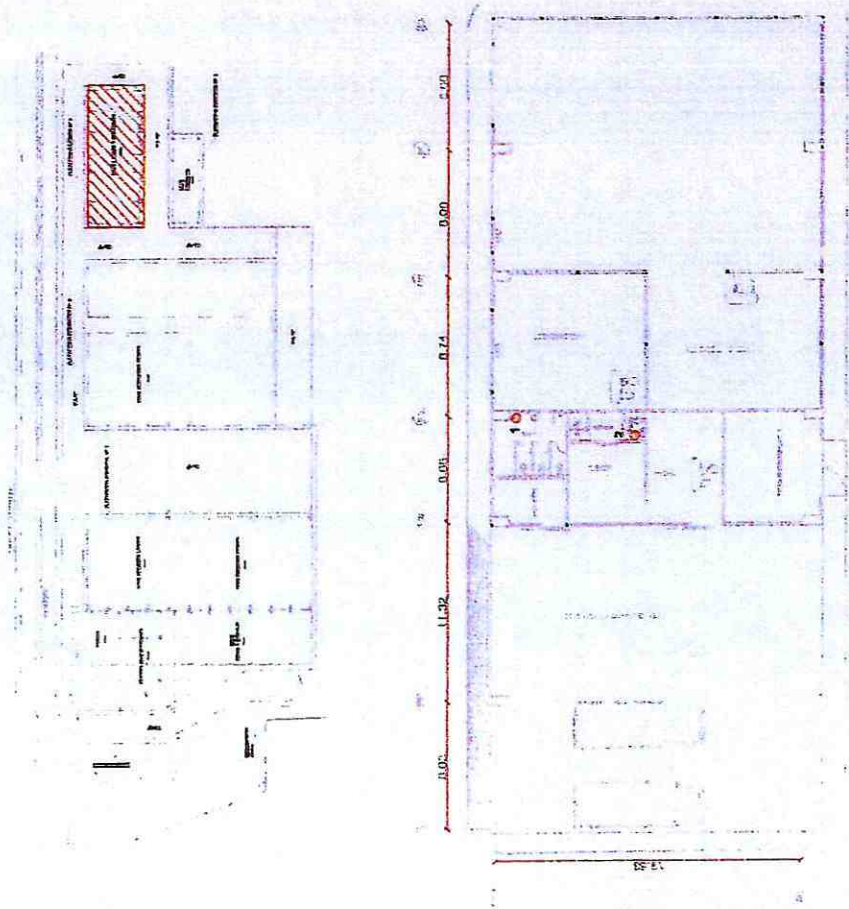

PLANTA ARQUITECTONICA - NAVE LAVADO ENGRASADO

[Signature]
CONTINUA

UBICACION - SECADOR DE MANOS

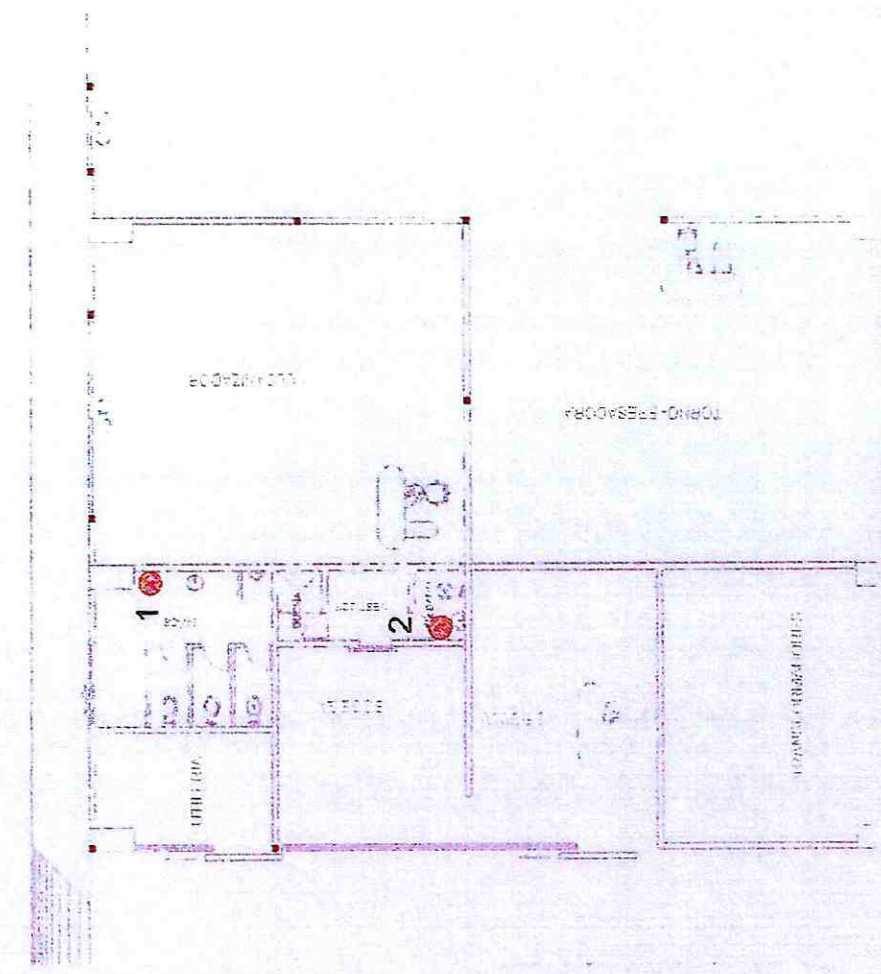

PLANTA ARQUITECTONICA - SECADOR DE MANOS

[Signature]
FISIAUACION

GOBIERNO AUTÓNOMO DESCENTRALIZADO DE LA PROVINCIA DEL PASTAZA

PROYECTO * CONSTRUCCIÓN DE LOS HANGARES DEL GOBIERNO AUTÓNOMO DESCENTRALIZADO PROVINCIAL DE PASTAZA (GADPPz) I ETAPA, PARROQUIA FÁTIMA, CANTÓN Y PROVINCIA DE PASTAZA *
PLANILLA DE AVANCE DE OBRA No. 23

RUBRO N° 276 ANEXO 1
DESCRIPCIÓN: BASURERO CILINDRICO A PEDAL D=250mm H=385 PARA BAÑO ACERO INOX. 304
UNIDAD: u
PERIODO: 01-jun 30-jun



PAG. 1 DE 1

BASURERO CILINDRICO A PEDAL D=250mm H=385 PARA BAÑO ACERO INOX. 304				
HAVE LAVADORA, Y TALLERES CHAPISTERIA-CARPINTERIA				
DESCRIPCION	CANTIDAD	DIMENSION	TOTAL	GRAFICO #
BAÑOS	3,00	-	3,00	ANEXO # 1
1/2 BAÑO	1,00	-	1,00	ANEXO # 1
			TOTAL	4,00

RESUMEN DE PLANILLA AL 100%					
DESCRIPCION	CONTRATADO	ANTERIOR	ACTUAL	ACUMULADO	UNIDAD
BASURERO CILINDRICO A PEDAL D=250mm H=385 PARA BAÑO ACERO INOX. 304	4,00	-	4,00	4,00	u

CONTRATISTA

ESCALIZACIÓN

" CONSTRUCCIÓN DE LOS HANGARES DEL GOBIERNO AUTÓNOMO DESCENTRALIZADO PROVINCIAL DE PASTAZA
(GADPPz) | ETAPA, PARROQUIA FÁTIMA, CANTÓN Y PROVINCIA DE PASTAZA "

RUBRO	276	ANEXO: 1
DESCRIPCIÓN	BASURERO CILINDRICO A PEDAL D=250mm H=385 PARA BAÑO ACERO INOX. 304	
UNIDAD	U	
PERIODO	1 DE JUNIO 2021 A 30 DE JUNIO 2021	



UBICACION - NAVE DE LAVADO ENGRASADO

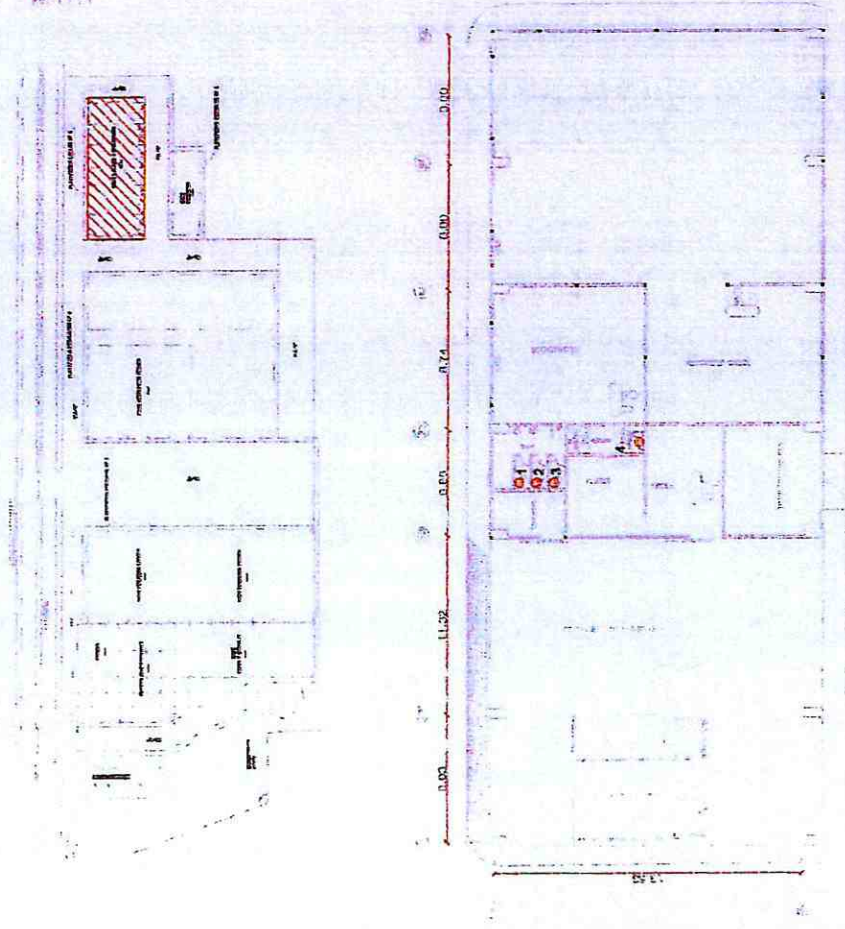

PLANTA ARQUITECTONICA - NAVE LAVADO ENGRASADO

UBICACION - NAVE DE LAVADO ENGRASADO

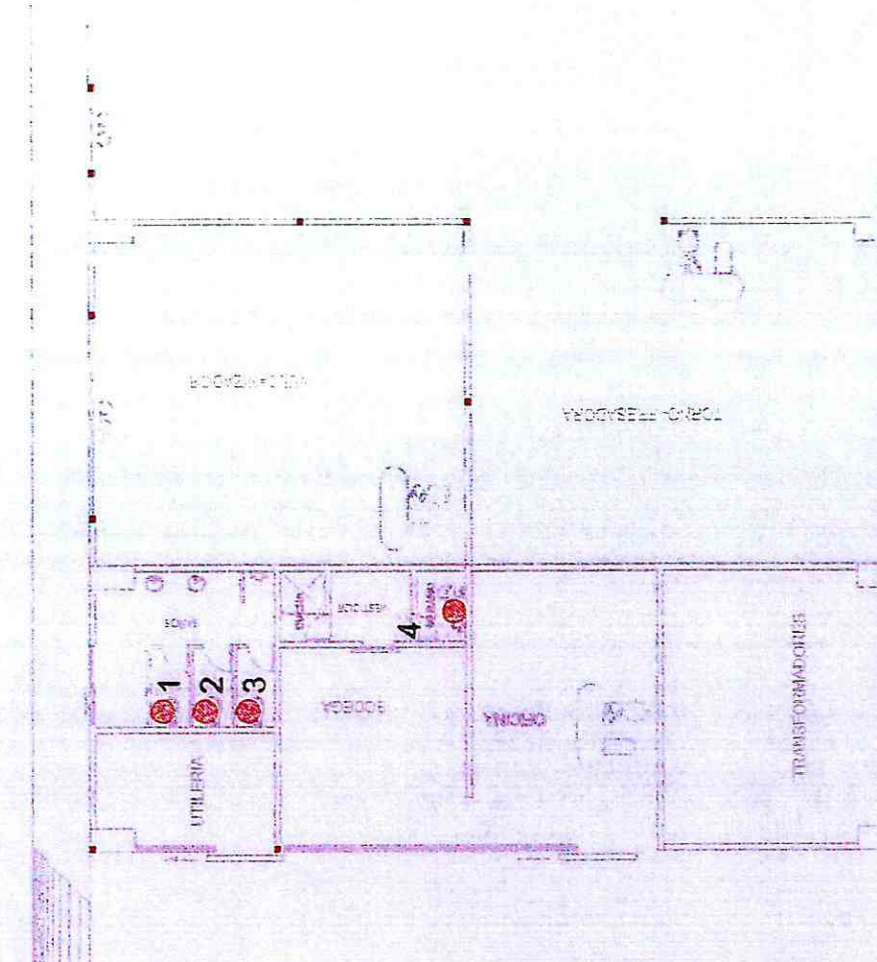

PLANTA ARQUITECTONICA - BASURERO CILINDRICO

[Signature]
CONTRATISTA

[Signature]
FISCALIZACIÓN

GOBIERNO AUTÓNOMO DESCENTRALIZADO DE LA PROVINCIA DEL PASTAZA

PROYECTO * CONSTRUCCIÓN DE LOS HANGARES DEL GOBIERNO AUTÓNOMO DESCENTRALIZADO PROVINCIAL DE PASTAZA (GADPPz) I ETAPA, PARROQUIA FÁTIMA, CANTÓN Y PROVINCIA DE PASTAZA *
PLANILLA DE AVANCE DE OBRA No. 23

RUBRO N° 277
DESCRIPCIÓN: DuCHAS CON mEZCLADORA (CON ACCESORIOS)
UNIDAD: u
PERIODO: 01-jun 30-jun

ANEXO 1



PAG. 1 DE 1

DuCHAS CON mEZCLADORA (CON ACCESORIOS)				
NAVE LAVADORA, Y TALLERES CHAPISTERIA-CARPINTERIA				
DESCRIPCION	CANTIDAD	DIMENSION	TOTAL	GRAFICO #
1/2 BAÑO	1,00	-	1,00	ANEXO # 1
			TOTAL	1,00

RESUMEN DE PLANILLA AL 100%					
DESCRIPCION	CONTRATADO	ANTERIOR	ACTUAL	ACUMULADO	UNIDAD
DuCHAS CON mEZCLADORA (CON ACCESORIOS)	1,00	-	1,00	1,00	u

CONTRATISTA

FISCALIZACIÓN

GOBIERNO AUTÓNOMO DESCENTRALIZADO DE PASTAZA

"CONSTRUCCIÓN DE LOS HANGARES DEL GOBIERNO AUTÓNOMO DESCENTRALIZADO PROVINCIAL DE PASTAZA (GADPPZ) I ETAPA, PARROQUIA FÁTIMA, CANTÓN Y PROVINCIA DE PASTAZA."

PROYECTO:

RUBRO	277
DESCRIPCION	DUCHAS CON MEZCLADORA (CON ACCESORIOS)
UNIDAD	U
PERIODO	1 DE JUNIO 2021 A 30 DE JUNIO 2021

ANEXO: 1



UBICACION - NAVE DE LAVADO ENGRASADO

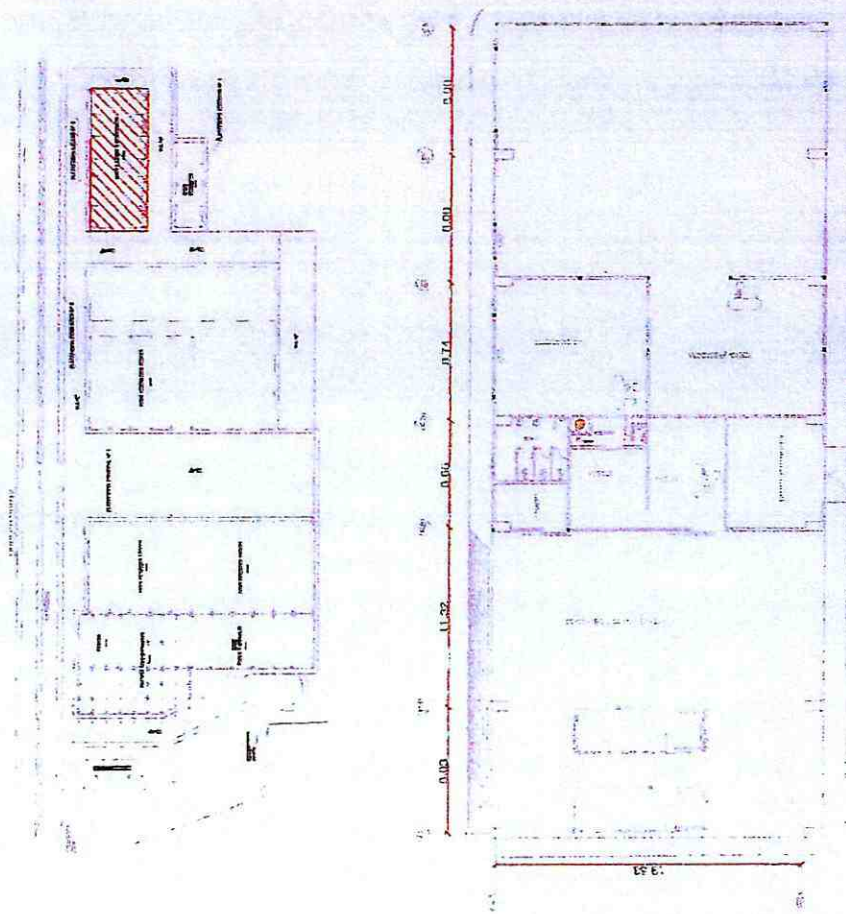

PLANTA ARQUITECTONICA - NAVE LAVADO ENGRASADO

[Signature]
CONTRATISTA

UBICACION - NAVE DE LAVADO ENGRASADO

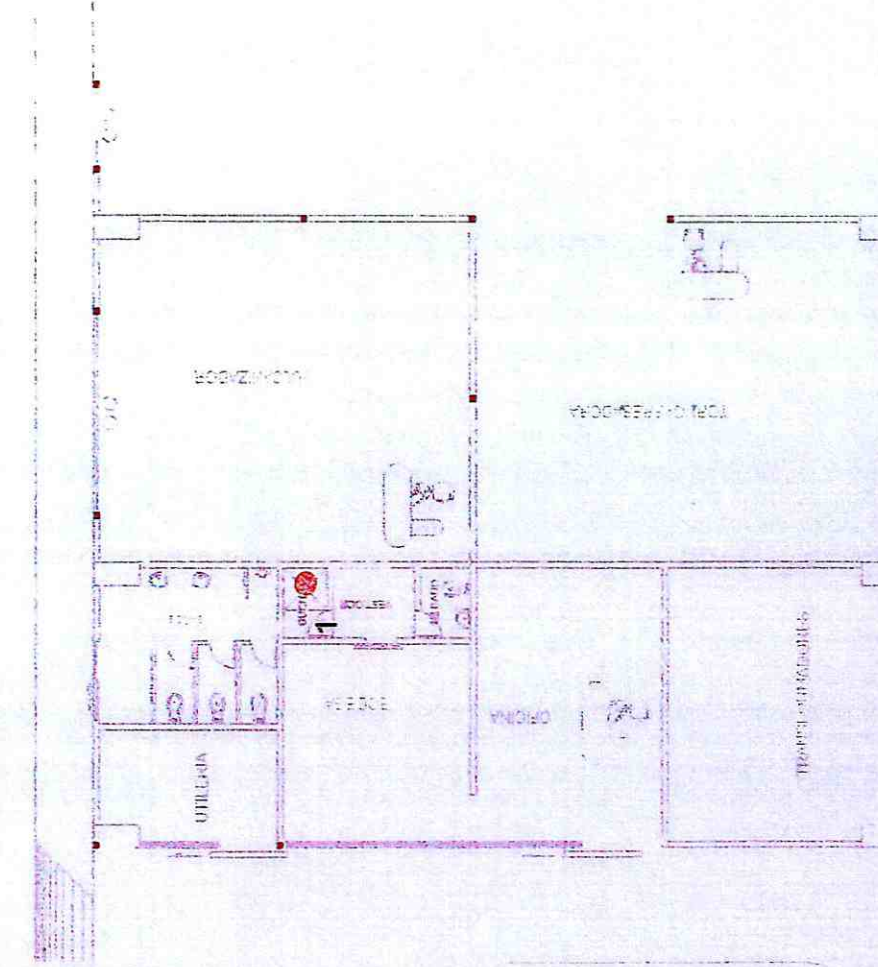

PLANTA ARQUITECTONICA - DUCHAS CON MEZCLADOR

[Signature]
FISCALIZACIÓN

BIERNO AUTONOMO DESCENTRALIZADO DE LA
PROVINCIA DEL PASTAZA

PROYECTO: " CONSTRUCCIÓN DE LOS HANGARES DEL GOBIERNO AUTÓNOMO DESCENTRALIZADO PROVINCIAL DE PASTAZA
(GADPPz) I ETAPA, PARROQUIA FÁTIMA, CANTÓN Y PROVINCIA DE PASTAZA "



RUBRO	336	ANEXO: 1
DESCRIPCION	Luminaria LED 24W/120 VOLTIOS	
UNIDAD	U	
PERIODO	1 DE JUNIO 2021 A 30 DE JUNIO 2021	

NAVE PRINCIPAL (RIEGO Y DRENAJE) NIVEL +5.09

UBICACIÓN

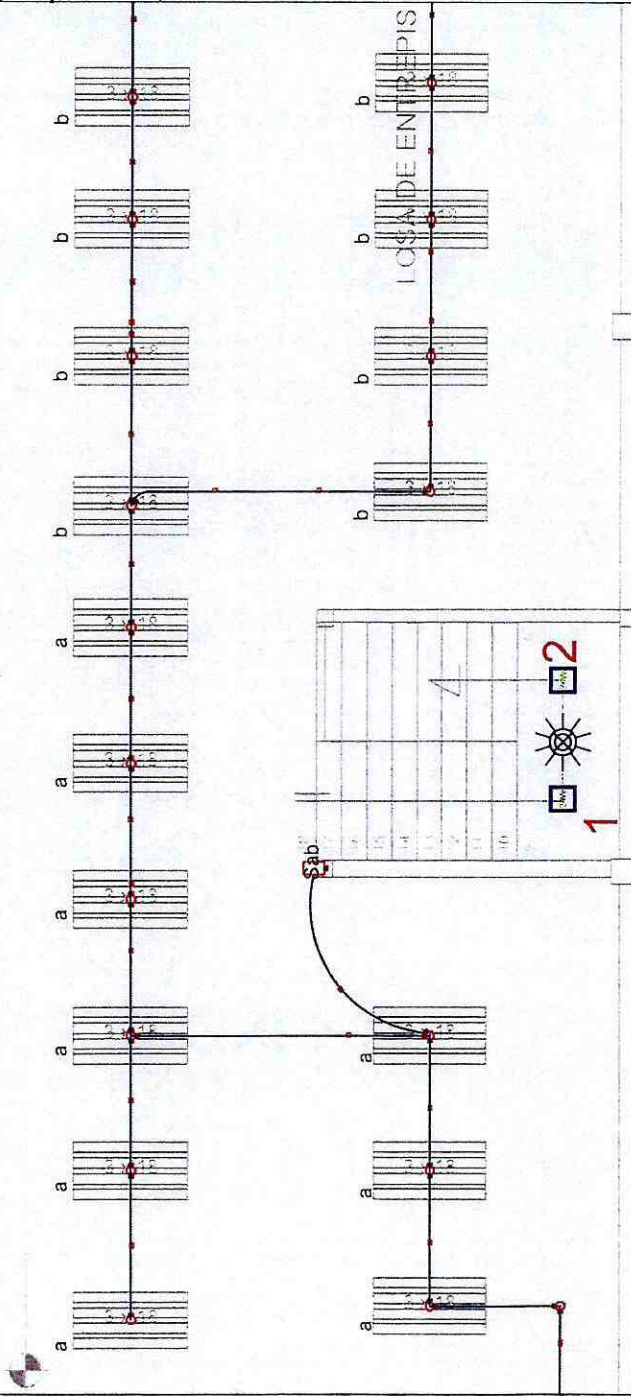
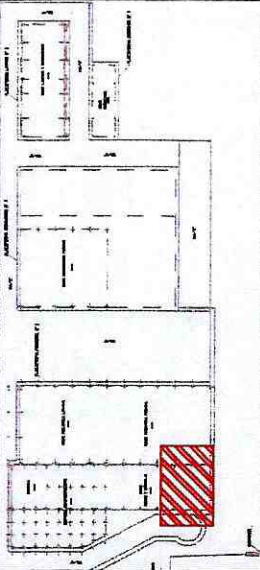

PLANTA ALTA

[Signature]
FISCALIZACIÓN

[Signature]
CONTRATISTA

PROYECTO

" CONSTRUCCION DE LOS HANGARES DEL GOBIERNO AUTÓNOMO DESCENTRALIZADO PROVINCIAL DE PASTAZA (GADPP); I ETAPA, PARROQUIA FÁTIMA, CANTON Y PROVINCIA DE PASTAZA "

PLANILLA DE AVANCE DE OBRA No. 23

RUBRO N° 340

ANEXO 1

DESCRIPCION: TuBERIA EmT 1/2 PuLGADA

UNIDAD: m

PERIODO: 01-jun 30-jun



PAG. 1 DE 1

Descripción	Cantidad	Dimensión	Total	GRAFICO #
TuBERIA EmT 1/2 PuLGADA (TRAMO A - BLOQUE ADMINISTRATIVO PLANTA BAJA)	2,32		2,32	ANEXO 1
TuBERIA EmT 1/2 PuLGADA (TRAMO B - BLOQUE ADMINISTRATIVO PLANTA BAJA)	2,32		2,32	
TuBERIA EmT 1/2 PuLGADA (TRAMO C - BLOQUE ADMINISTRATIVO PLANTA BAJA)	3,94		3,94	
TuBERIA EmT 1/2 PuLGADA (TRAMO D - BLOQUE ADMINISTRATIVO PLANTA BAJA)	2,88		2,88	
TOTAL:			11,46	

RESUMEN DE PLANILLA AL 100%					
DESCRIPCION	780.00	1133.82	ACTUAL	ACUMULADO	UNIDAD
TuBERIA EmT 1/2 PuLGADA	780.00	1.133.82	0.00	1.133.82	m

RESUMEN DE PLANILLA DE INCREMENTOS						
DESCRIPCION	CONTRATADO	ANTERIOR	ACTUAL	INCR. ANT.	INCR. ACT.	UNIDAD
TuBERIA EmT 1/2 PuLGADA	780.00	1.133.82	0.00	0.00	11.46	m

CONTRATISTA

FISCALIZACIÓN

BIERNO AUTONOMO DESCENTRALIZADO DE LA PROVINCIA DEL PASTAZA

"CONSTRUCCIÓN DE LOS HANGARES DEL GOBIERNO AUTÓNOMO DESCENTRALIZADO PROVINCIAL DE PASTAZA (GADPP2) I ETAPA, PARROQUIA FÁTIMA, CANTÓN Y PROVINCIA DE PASTAZA"

ANEXO: 1

RUBRO	340
DESCRIPCIÓN	TUBERIA EmT 1/2 PULGADA
UNIDAD	m
PERIODO	1 DE JUNIO 2021 A 30 DE JUNIO 2021

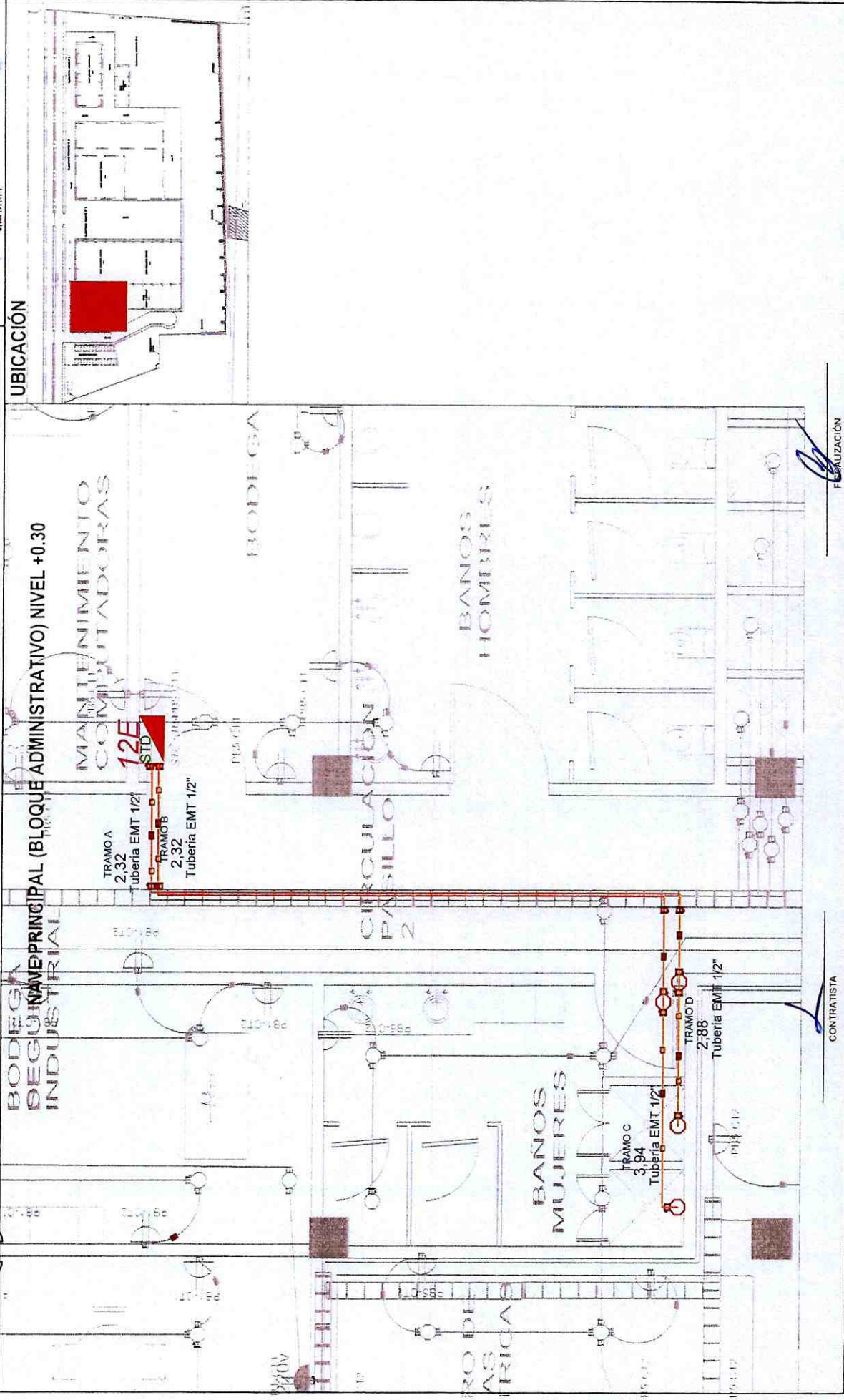

UBICACIÓN

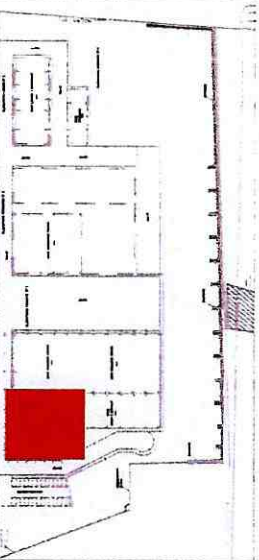

CONTRATISTA

FIRMA

GOBIERNO AUTÓNOMO DESCENTRALIZADO DE LA PROVINCIA DEL PASTAZA

PROYECTO " CONSTRUCCIÓN DE LOS HANGARES DEL GOBIERNO AUTONOMO DESCENTRALIZADO PROVINCIAL DE PASTAZA (GADPP); I ETAPA, PARROQUIA FATIMA, CANTON Y PROVINCIA DE PASTAZA "

PLANILLA DE AVANCE DE OBRA No. 23

RUBRO N° 341
 DESCRIPCIÓN: UNION EmT 1/2 PuLGADA ANEXO 1
 UNIDAD: u
 PERIODO: 01-jun 30-jun



PAG. 1 DE 1

Descripción	Cantidad	Dimensión	Total	GRAFICO #
UNION EmT 1/2 PuLGADA	6,00		6,00	ANEXO 1
TOTAL:			6,00	

RESUMEN DE PLANILLA AL 100%					
DESCRIPCION	260,00	249,00	ACTUAL	ACUMULADO	UNIDAD
UNION EmT 1/2 PuLGADA	260,00	249,00	6,00	255,00	u



 CONTRATISTA



 FISCALIZACIÓN

BIERNO AUTONOMO DESCENTRALIZADO DE LA PROVINCIA DEL PASTAZA

" CONSTRUCCIÓN DE LOS HANGARES DEL GOBIERNO AUTÓNOMO DESCENTRALIZADO PROVINCIAL DE PASTAZA (GADPP2) I ETAPA, PARROQUIA FÁTIMA, CANTÓN Y PROVINCIA DE PASTAZA "

RUBRO	341	ANEXO: 1
DESCRIPCION	UNION EmT 1/2 PulGADA	
UNIDAD	U	
PERIODO	1 DE JUNIO 2021 A 30 DE JUNIO 2021	

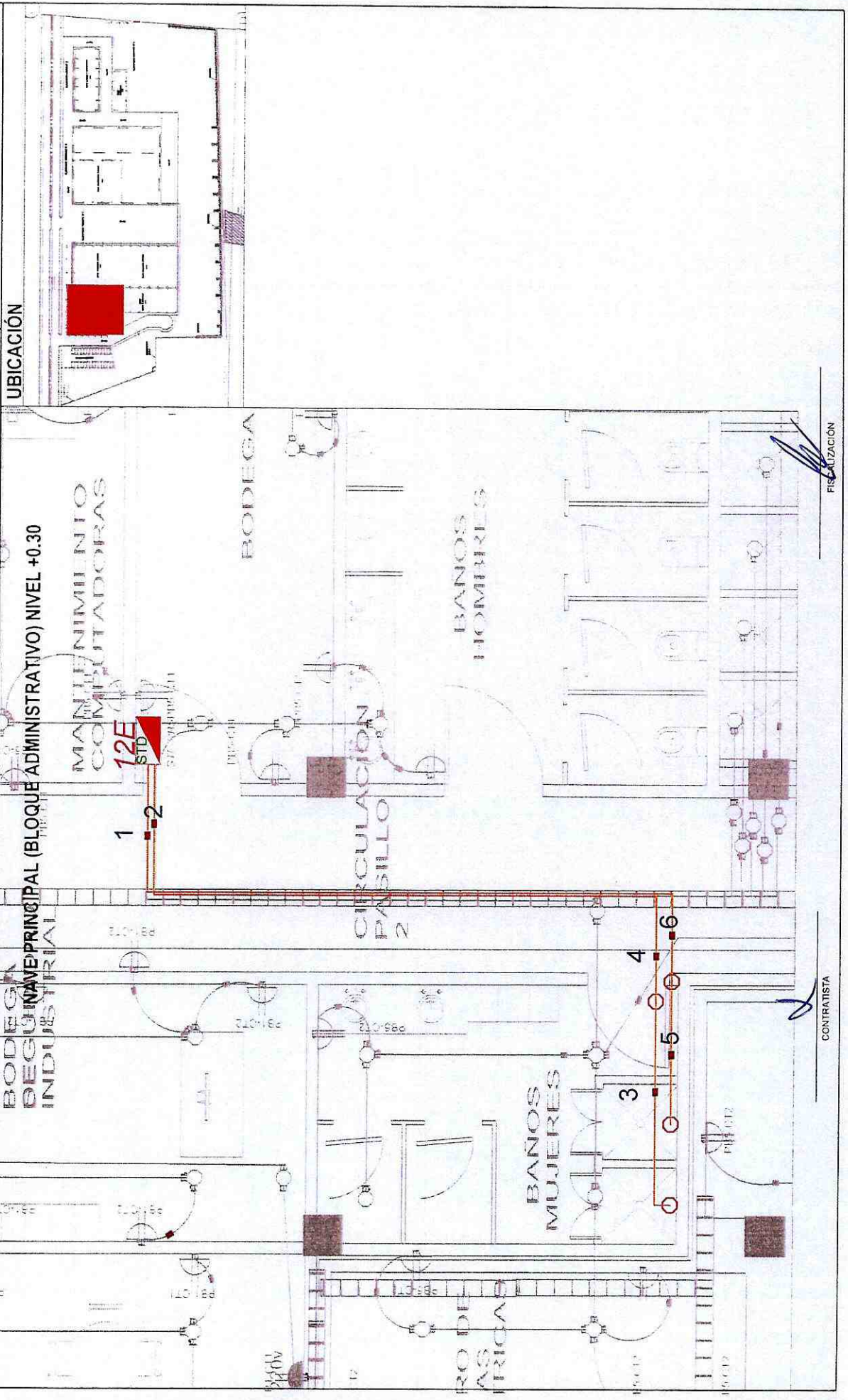

UBICACIÓN

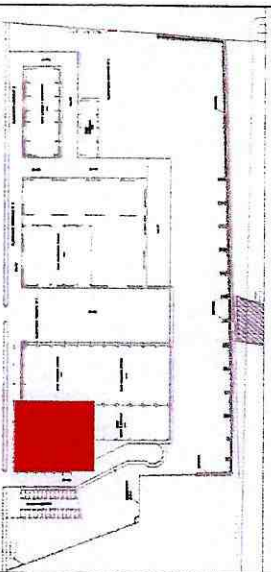

CONTRATISTA

REALIZACIÓN

PROYECTO "CONSTRUCCIÓN DE LOS HANGARES DEL GOBIERNO AUTONOMO DESCENTRALIZADO PROVINCIAL DE PASTAZA (GADPP); I ETAPA, PARROQUIA FATIMA, CANTÓN Y PROVINCIA DE PASTAZA "

PLANILLA DE AVANCE DE OBRA No. 23

RUBRO N° 342 ANEXO 1
 DESCRIPCIÓN: CONECTOR EmT 1/2 PuLGADA
 UNIDAD: u
 PERIODO: 01-jun 30-jun



PAG. 1 DE 1

Descripción	Cantidad	Dimensión	Total	GRAFICO #
CONECTOR EmT 1/2 PuLGADA	12,00		12,00	ANEXO 1
TOTAL:			12,00	

RESUMEN DE PLANILLA AL 100%					
DESCRIPCIÓN	570,00	595,00	ACTUAL	ACUMULADO	UNIDAD
CONECTOR EmT 1/2 PuLGADA	570,00	595,00	0,00	595,00	u

RESUMEN DE PLANILLA DE INCREMENTOS						
DESCRIPCIÓN	CONTRATADO	ANTERIOR	ACTUAL	INCR. ANT.	INCR. ACT.	UNIDAD
CONECTOR EmT 1/2 PuLGADA	570,00	595,00	0,00	0,00	12,00	u

 CONTRATISTA

 FISCALIZACIÓN

**BIERNO AUTONOMO DESCENTRALIZADO DE LA
PROVINCIA DEL PASTAZA**

" CONSTRUCCIÓN DE LOS HANGARES DEL GOBIERNO AUTÓNOMO DESCENTRALIZADO PROVINCIAL DE PASTAZA
(GADPPz) I ETAPA, PARROQUIA FÁTIMA, CANTÓN Y PROVINCIA DE PASTAZA "

RUBRO 342
DESCRIPCION CONECTOR EmT 1/2 Pulgada
UNIDAD U
PERIODO 1 DE JUNIO 2021 A 30 DE JUNIO 2021

ANEXO: 1



UBICACIÓN

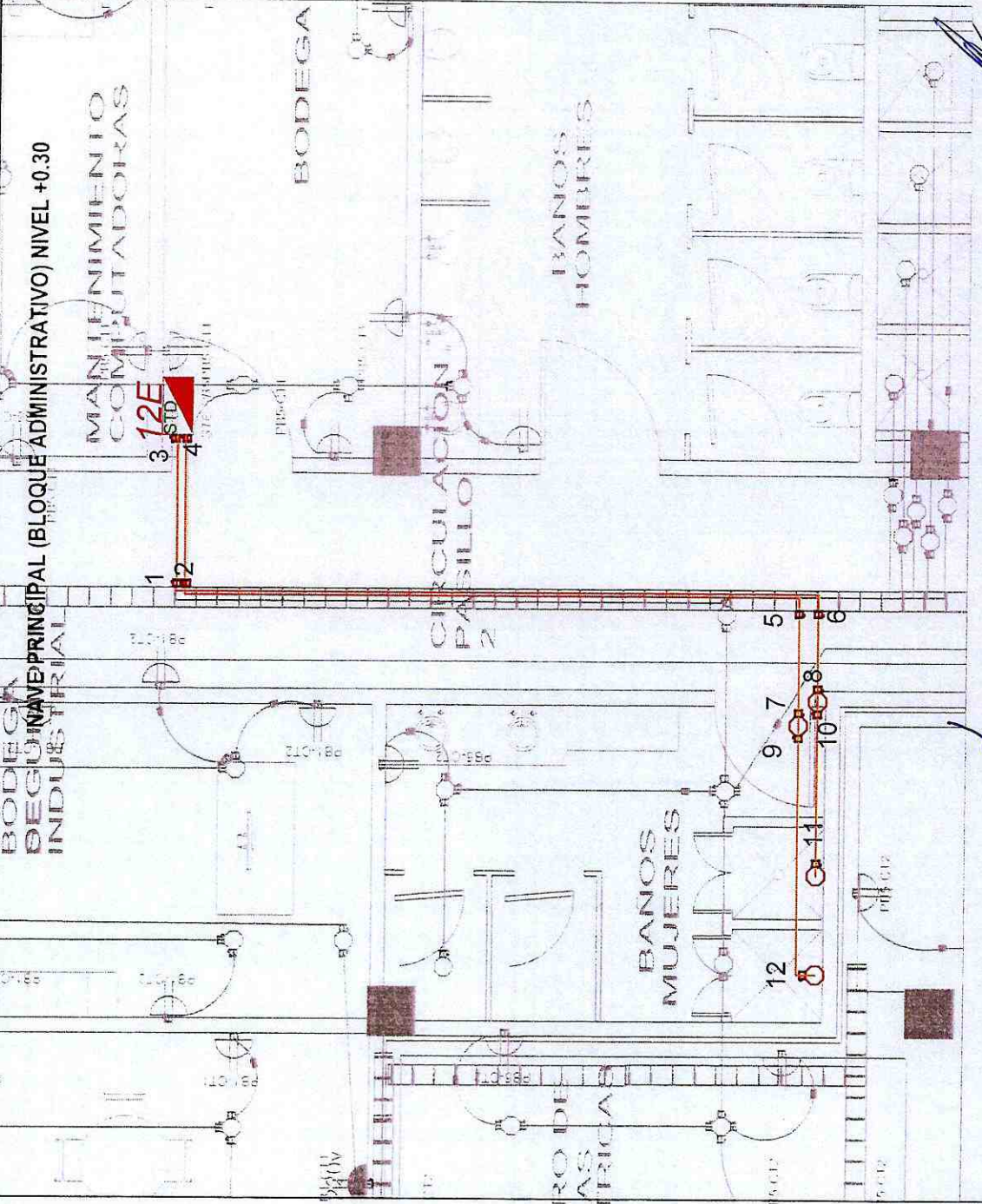
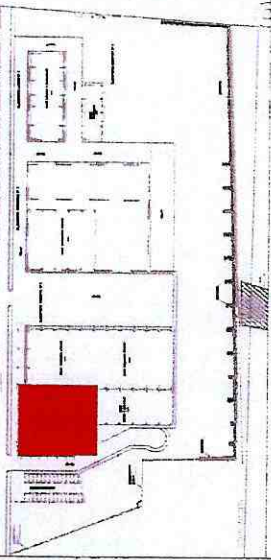

CONTRATISTA

FISCALIZACIÓN

PROYECTO " CONSTRUCCIÓN DE LOS HANGARES DEL GOBIERNO AUTÓNOMO DESCENTRALIZADO PROVINCIAL DE PASTAZA (GADPP) I ETAPA, PARROQUIA FÁTIMA, CANTÓN Y PROVINCIA DE PASTAZA "

PLANILLA DE AVANCE DE OBRA No. 23

RUBRO N° 343 ANEXO 1
 DESCRIPCIÓN: FIJACION DE TUBOS EN LOZA CON GRAPA METALICA EmT 1/2 PULGADA
 UNIDAD: u
 PERIODO: 01-jun 30-jun



PAG. 1 DE 1

Descripción	Cantidad	Dimensión	Total	GRAFICO #
FIJACION DE TUBOS EN LOZA CON GRAPA METALICA EmT 1/2 PULGADA	8,00		8,00	ANEXO 1
TOTAL:	8,00		8,00	

RESUMEN DE PLANILLA AL 100%					
DESCRIPCION	390,00	234,00	ACTUAL	ACUMULADO	UNIDAD
FIJACION DE TUBOS EN LOZA CON GRAPA METALICA EmT 1/2 PULGADA	390,00	234,00	8,00	242,00	u

 CONTRASTA

 FISCALIZACIÓN

BIERNO AUTONOMO DESCENTRALIZADO DE LA PROVINCIA DEL PASTAZA

"CONSTRUCCIÓN DE LOS HANGARES DEL GOBIERNO AUTÓNOMO DESCENTRALIZADO PROVINCIAL DE PASTAZA (GADPPz) I ETAPA, PARROQUIA FÁTIMA, CANTÓN Y PROVINCIA DE PASTAZA"

343

FIJACION DE TUBOS EN LOZA CON GRAPA METALICA EmT 1/2 Pul GADA

ANEXO: 1

1 DE JUNIO 2021 A 30 DE JUNIO 2021

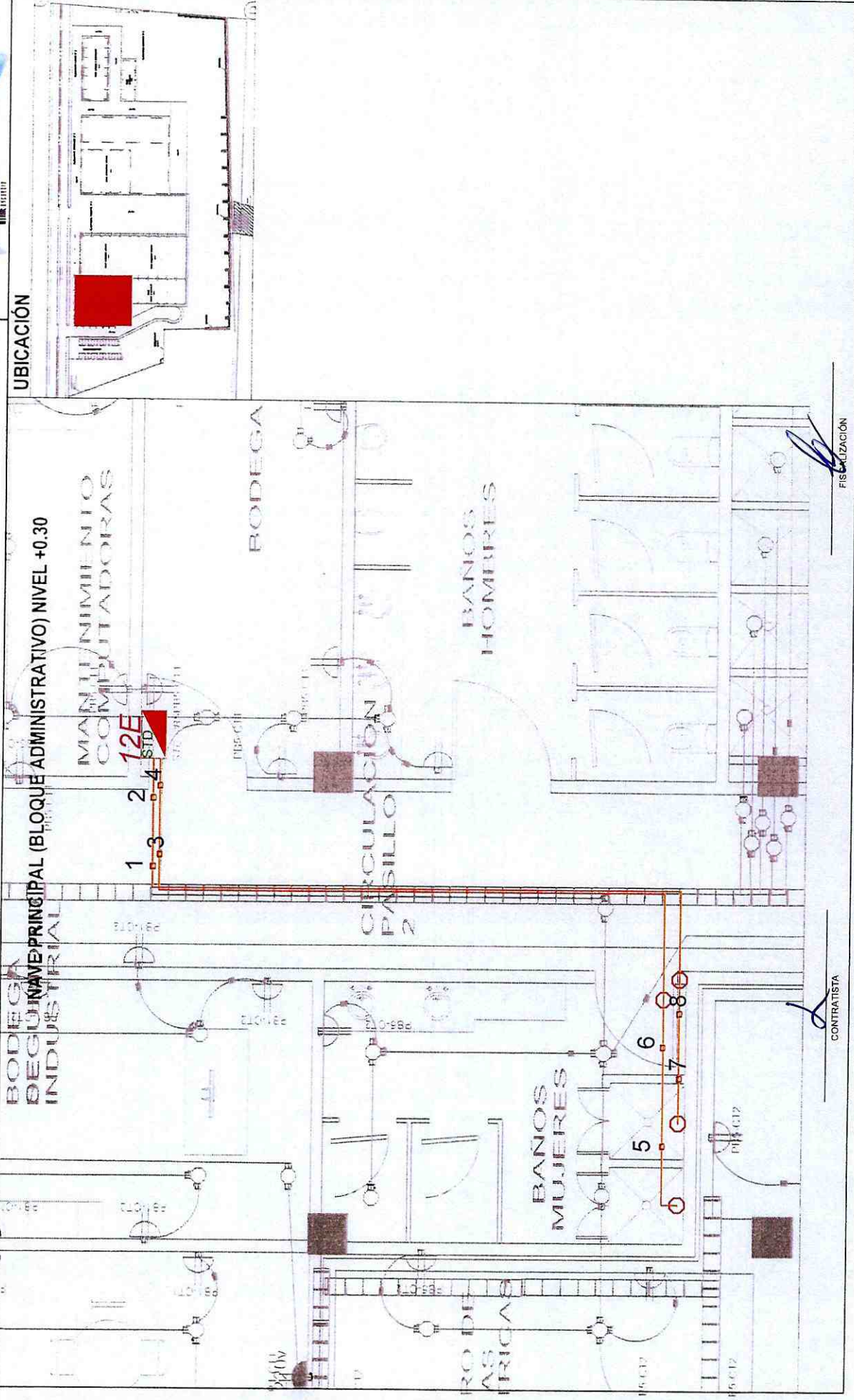

UBICACIÓN

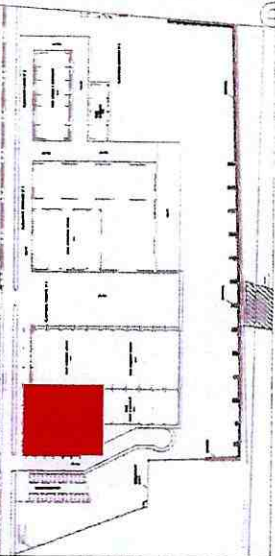

CONTRATISTA

FISCALIZACIÓN

PROYECTO "CONSTRUCCIÓN DE LOS HANGARES DEL GOBIERNO AUTÓNOMO DESCENTRALIZADO PROVINCIAL DE PASTAZA (GADPP) | ETAPA, PARROQUIA FÁTIMA, CANTÓN Y PROVINCIA DE PASTAZA"

PLANILLA DE AVANCÉ DE OBRA No. 23

RUBRO N° 344

ANEXO 1

DESCRIPCIÓN: TENDIDO DE CABLE FLEXIBLE DE COBRE NO.10 AWG COLOR AZUL (INC. TAYPE)

UNIDAD: m

PERIODO: 01-jun 30-jun



PAG. 1 DE 1

Descripción	Cantidad	Dimensión	Total	GRAFICO #
TENDIDO DE CABLE FLEXIBLE DE COBRE NO.10 AWG COLOR AZUL (INC. TAYPE) - TRAMO A DUCHAS PLANTA BAJA ADMIN.	3,49		3,49	ANEXO 1
TENDIDO DE CABLE FLEXIBLE DE COBRE NO.10 AWG COLOR AZUL (INC. TAYPE) - TRAMO B DUCHAS PLANTA BAJA ADMIN.	8,71		8,71	
TENDIDO DE CABLE FLEXIBLE DE COBRE NO.10 AWG COLOR AZUL (INC. TAYPE) - TRAMO C DUCHAS PLANTA BAJA ADMIN.	4,68		4,68	
TENDIDO DE CABLE FLEXIBLE DE COBRE NO.10 AWG COLOR AZUL (INC. TAYPE) - TRAMO D DUCHAS PLANTA BAJA ADMIN.	1,50		1,50	
TENDIDO DE CABLE FLEXIBLE DE COBRE NO.10 AWG COLOR AZUL (INC. TAYPE) - TRAMO E DUCHAS PLANTA BAJA ADMIN.	3,49		3,49	
TENDIDO DE CABLE FLEXIBLE DE COBRE NO.10 AWG COLOR AZUL (INC. TAYPE) - TRAMO F DUCHAS PLANTA BAJA ADMIN.	8,82		8,82	
TENDIDO DE CABLE FLEXIBLE DE COBRE NO.10 AWG COLOR AZUL (INC. TAYPE) - TRAMO G DUCHAS PLANTA BAJA ADMIN.	3,25		3,25	
TENDIDO DE CABLE FLEXIBLE DE COBRE NO.10 AWG COLOR AZUL (INC. TAYPE) - TRAMO H DUCHAS PLANTA BAJA ADMIN.	1,50		1,50	
TOTAL:			35,44	

RESUMEN DE PLANILLA AL 100%					
DESCRIPCION	CONTRATADO	ANTERIOR	ACTUAL	ACUMULADO	UNIDAD
TENDIDO DE CABLE FLEXIBLE DE COBRE NO.10 AWG COLOR AZUL (INC. TAYPE)	892,00	1.174,63	0,00	1.174,63	m

RESUMEN DE PLANILLA DE INCREMENTOS						
DESCRIPCION	CONTRATADO	ANTERIOR	ACTUAL	INCR. ANT.	INCR. ACT.	UNIDAD
TENDIDO DE CABLE FLEXIBLE DE COBRE NO.10 AWG COLOR AZUL (INC. TAYPE)	892,00	1.174,63	0,00	0,00	35,44	m

CONTRATISTA

FISCALIZACIÓN

**BIERNO AUTONOMO DESCENTRALIZADO DE LA
PROVINCIA DEL PASTAZA**

PROYECTO: " CONSTRUCCIÓN DE LOS HANGARES DEL GOBIERNO AUTÓNOMO DESCENTRALIZADO PROVINCIAL DE PASTAZA
(GADPPz) I ETAPA, PARROQUIA FÁTIMA, CANTÓN Y PROVINCIA DE PASTAZA "



RUBRO	344
DESCRIPCIÓN	TENDIDO DE CABLE FLEXIBLE DE COBRE NO.10 AWG COLOR AZUL. (INC. TAYPE)
UNIDAD	m
PERIODO	1 DE JUNIO 2021 A 30 DE JUNIO 2021

ANEXO: 1

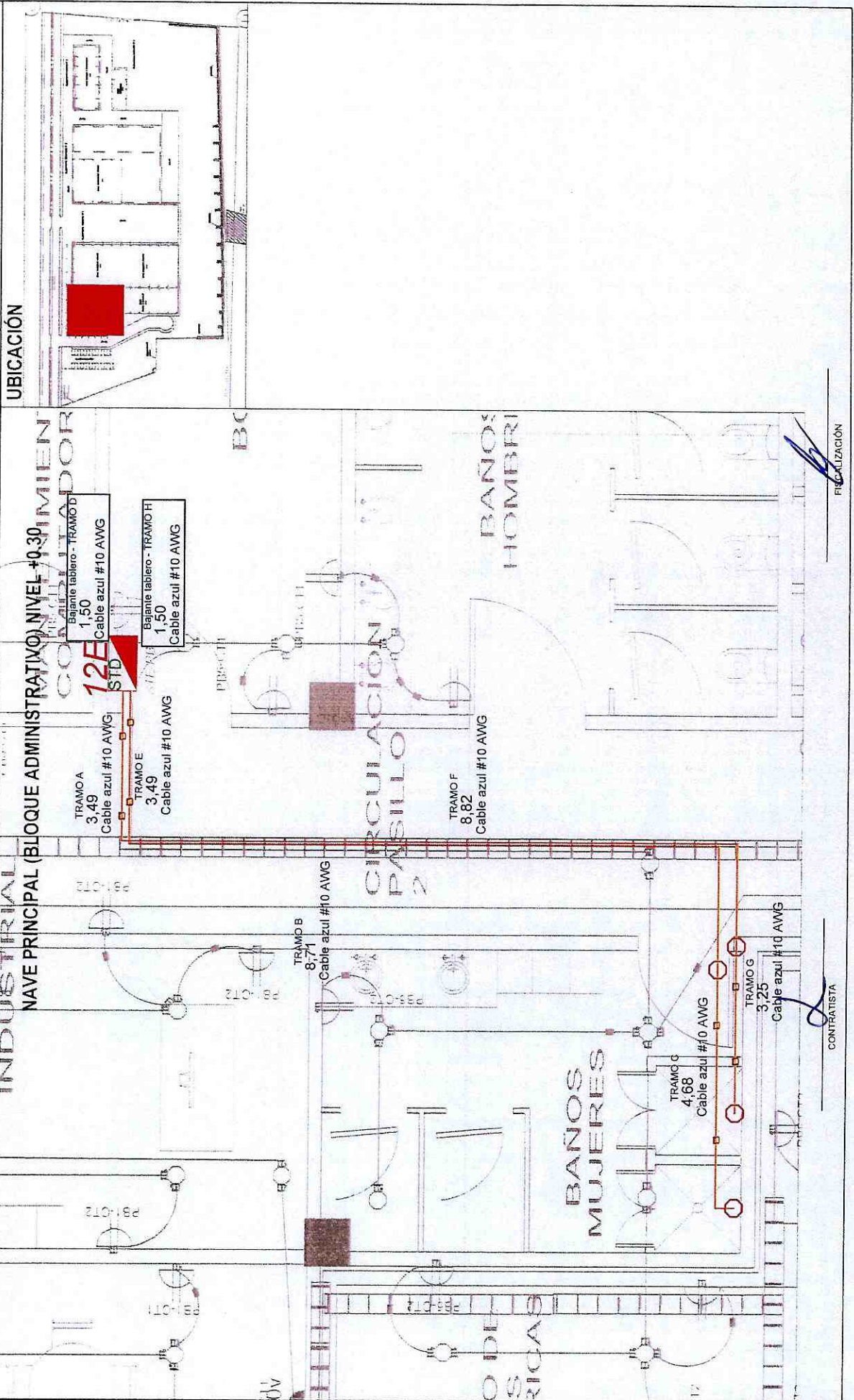

UBICACIÓN

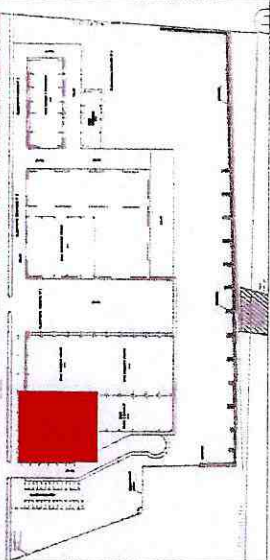

CONTRATISTA

REALIZACIÓN

BIERNO AUTONOMO DESCENTRALIZADO DE LA PROVINCIA DEL PASTAZA

* CONSTRUCCIÓN DE LOS HANGARES DEL GOBIERNO AUTÓNOMO DESCENTRALIZADO PROVINCIAL DE PASTAZA (GADPP2) I ETAPA, PARROQUIA FÁTIMA, CANTÓN Y PROVINCIA DE PASTAZA *

PROYECTO:	345	ANEXO: 1
RUBRO	TENDIDO DE CABLE FLEXIBLE DE COBRE NO.10 AWG COLOR BLANCO (INC. TAYPE)	
DESCRIPCION	m	
UNIDAD	1 DE JUNIO 2021 A 30 DE JUNIO 2021	
PERIODO		

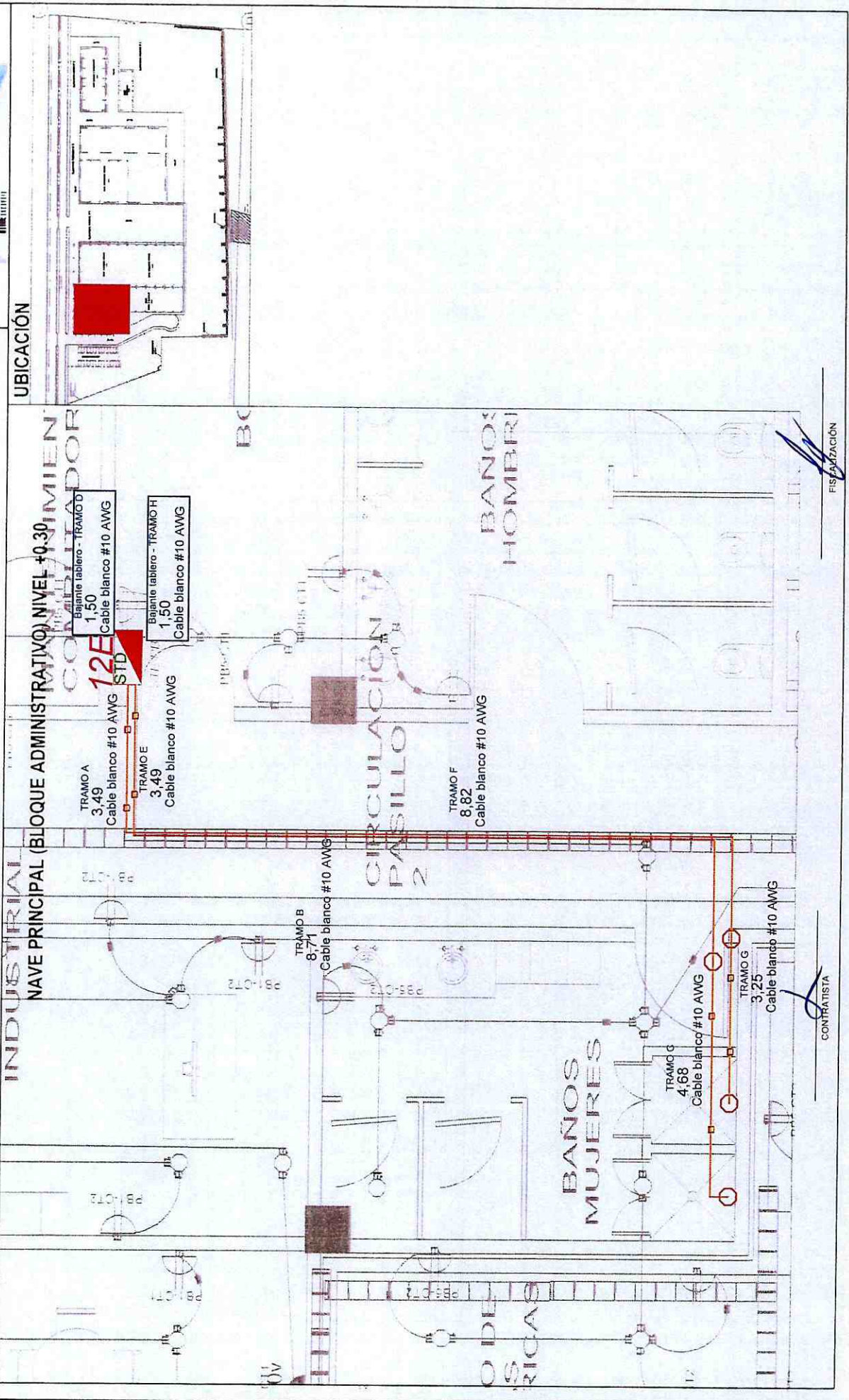

CONTRATISTA

FISCALIZACIÓN

BIERNO AUTONOMO DESCENTRALIZADO DE LA PROVINCIA DEL PASTAZA

"CONSTRUCCIÓN DE LOS HANGARES DEL GOBIERNO AUTÓNOMO DESCENTRALIZADO PROVINCIAL DE PASTAZA (GADPP2) | ETAPA, PARROQUIA FÁTIMA, CANTÓN Y PROVINCIA DE PASTAZA "

PROYECTO:	TENDIDO DE CABLE FLEXIBLE DE COBRE NO.14 AWG COLOR VERDE (INC. TAYPE)		
RUBRO	346	ANEXO:	1
DESCRIPCION	m		
UNIDAD			
PERIODO	1 DE JUNIO 2021 A 30 DE JUNIO 2021		

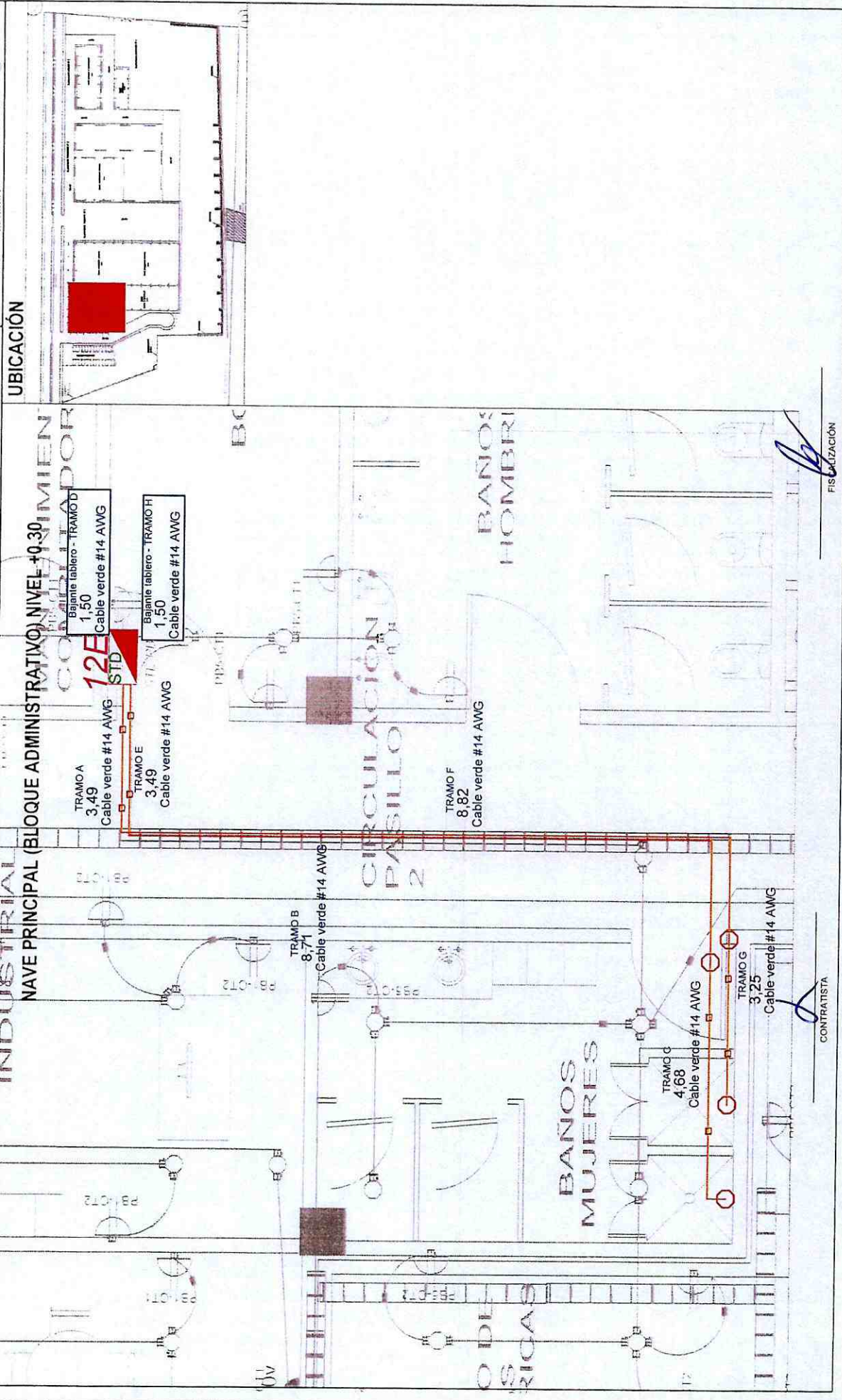

FISICAZIÓN

CONTRATISTA

PROYECTO "CONSTRUCCIÓN DE LOS HANGARES DEL GOBIERNO AUTÓNOMO DESCENTRALIZADO PROVINCIAL DE PASTAZA (GADPP2) I ETAPA, PARROQUIA FÁTIMA, CANTÓN Y PROVINCIA DE PASTAZA"

PLANILLA DE AVANCE DE OBRA No. 23

RUBRO N° 361 ANEXO 1
 DESCRIPCIÓN: FIJACION DE TuBOS EN LOZA CON GRAPA mETALICA EmT 1/2 PuLGADA
 UNIDAD: u
 PERIODO: 01-jun 30-jun



Descripción	Cantidad	Dimensión	Total	GRAFICO #
FIJACION DE TuBOS EN LOZA CON GRAPA mETALICA EmT 1/2 PuLGADA	172,00		172,00	ANEXO 1
TOTAL:			172,00	

RESUMEN DE PLANILLA AL 100%					
DESCRIPCIÓN	500,00	279,00	ACTUAL	ACUMULADO	UNIDAD
FIJACION DE TuBOS EN LOZA CON GRAPA mETALICA EmT 1/2 PuLGADA	500,00	279,00	172,00	451,00	u

 CONTRATISTA

 FISCALIZACIÓN

**BIERNO AUTONOMO DESCENTRALIZADO DE LA
PROVINCIA DEL PASTAZA**

" CONSTRUCCIÓN DE LOS HANGARES DEL GOBIERNO AUTÓNOMO DESCENTRALIZADO PROVINCIAL DE PASTAZA
(GADPPP) I ETAPA, PARROQUIA FATIMA, CANTÓN Y PROVINCIA DE PASTAZA "



RUBRO	361	ANEXO:	1/2
DESCRIPCION	FIJACION DE TUBOS EN LOZA CON GRAPA METALICA EmT 1/2 Pul.GADA		
UNIDAD	U		
PERIODO	1 DE JUNIO 2021 A 30 DE JUNIO 2021		

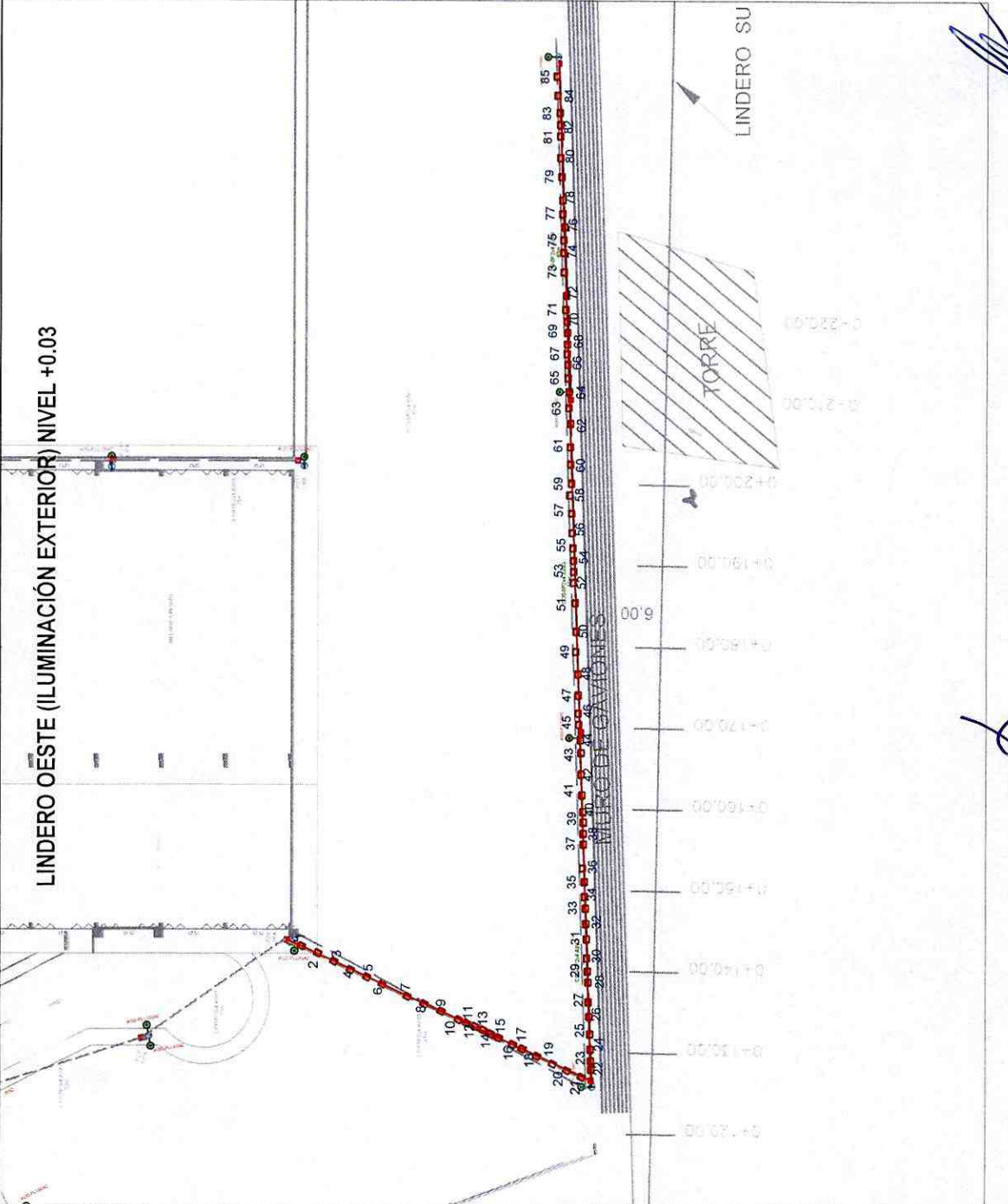
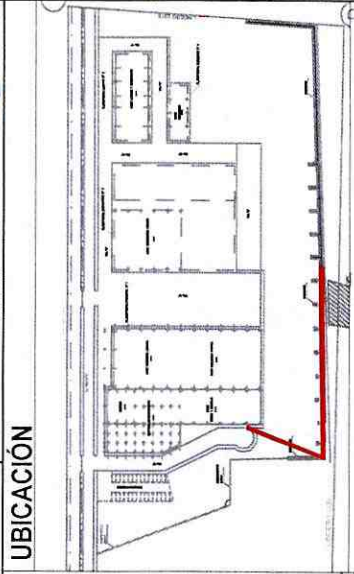

FISCALIZACIÓN

CONTRATISTA

**BIERNO AUTONOMO DESCENTRALIZADO DE LA
PROVINCIA DEL PASTAZA**

* CONSTRUCCIÓN DE LOS HANGARES DEL GOBIERNO AUTÓNOMO DESCENTRALIZADO PROVINCIAL DE PASTAZA
(GADPPz) I ETAPA, PARROQUIA FÁTIMA, CANTÓN Y PROVINCIA DE PASTAZA *

ANEXO: 2/2

361
FIJACION DE TUBOS EN LOZA CON GRAPA METALICA EmT 1/2 Pul.GADA

U
1 DE JUNIO 2021 A 30 DE JUNIO 2021

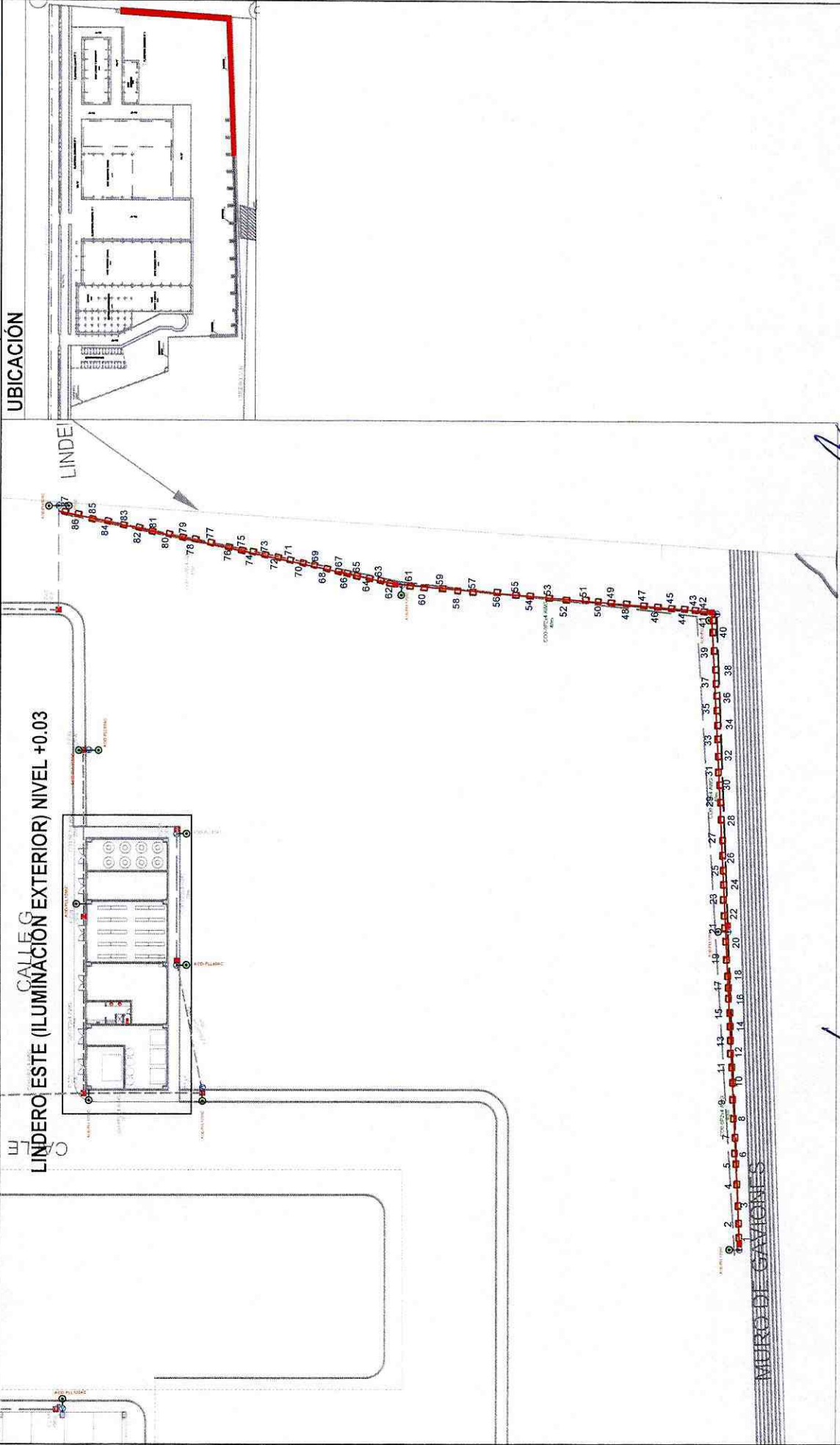

UBICACIÓN

FISCALIZACIÓN

CONTRATISTA

BIERNO AUTONOMO DESCENTRALIZADO DE LA PROVINCIA DEL PASTAZA

"CONSTRUCCIÓN DE LOS HANGARES DEL GOBIERNO AUTÓNOMO DESCENTRALIZADO PROVINCIAL DE PASTAZA (GADPPz) | ETAPA, PARROQUIA FÁTIMA, CANTÓN Y PROVINCIA DE PASTAZA"

PROYECTO:			
RUBRO	362	ANEXO:	1
DESCRIPCIÓN	CAJETINES METÁLICOS OCTOGONALES MEDIANOS CON TAPA		
UNIDAD	U		
PERIODO	1 DE JUNIO 2021 A 30 DE JUNIO 2021		

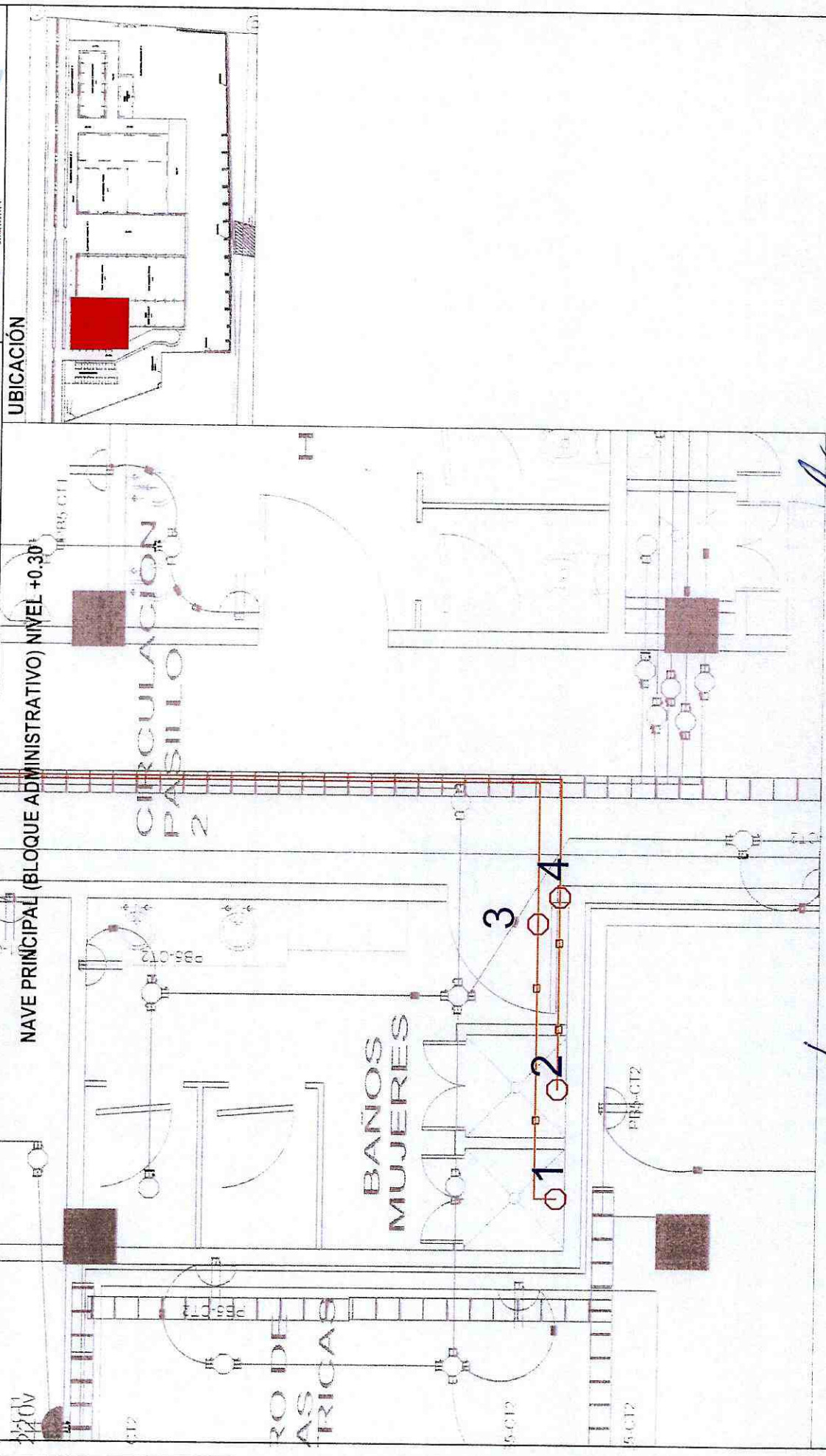

UBICACIÓN

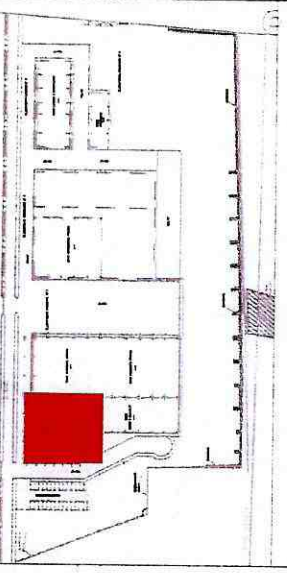

CONTRATISTA

FISCALIZACIÓN

PROYECTO: " CONSTRUCCIÓN DE LOS HANGARES DEL GOBIERNO AUTÓNOMO DESCENTRALIZADO PROVINCIAL DE PASTAZA (GADPPz) I ETAPA, PARROQUIA FÁTIMA, CANTÓN Y PROVINCIA DE PASTAZA "

PLANILLA DE AVANCE DE OBRA No. 23

RUBRO N° 365 ANEXO 1
 DESCRIPCION: TENDIDO DE CABLE FLEXIBLE DE COBRE NO.12 AWG COLOR AMARILLO (INC. TAYPE)
 UNIDAD: m
 PERIODO: 01-jun 30-jun



PAG. 1 DE 1

Descripción	Cantidad	Dimensión	Total	GRAFICO #
TENDIDO DE CABLE FLEXIBLE DE COBRE NO.12 AWG COLOR AMARILLO (INC. TAYPE)	30,00		30,00	ANEXO 1
TOTAL:			30,00	

RESUMEN DE PLANILLA AL 100%					
DESCRIPCION	CONTRATADO	ANTERIOR	ACTUAL	ACUMULADO	UNIDAD
TENDIDO DE CABLE FLEXIBLE DE COBRE NO.12 AWG COLOR AMARILLO (INC. TAYPE)	1.200,00	840,00	30,00	870,00	m

 CONTRATISTA

 FISCALIZACIÓN

**BIERNO AUTONOMO DESCENTRALIZADO DE LA
PROVINCIA DEL PASTAZA**

"CONSTRUCCIÓN DE LOS HANGARES DEL GOBIERNO AUTÓNOMO DESCENTRALIZADO PROVINCIAL DE PASTAZA
(GADPPz) I ETAPA, PARROQUIA FÁTIMA, CANTÓN Y PROVINCIA DE PASTAZA"

RUBRO	365	ANEXO: 1
DESCRIPCION	TENDIDO DE CABLE FLEXIBLE DE COBRE NO.12 AWG COLOR AMARILLO (INC. TAYPE)	
UNIDAD	m	
PERIODO	1 DE JUNIO 2021 A 30 DE JUNIO 2021	

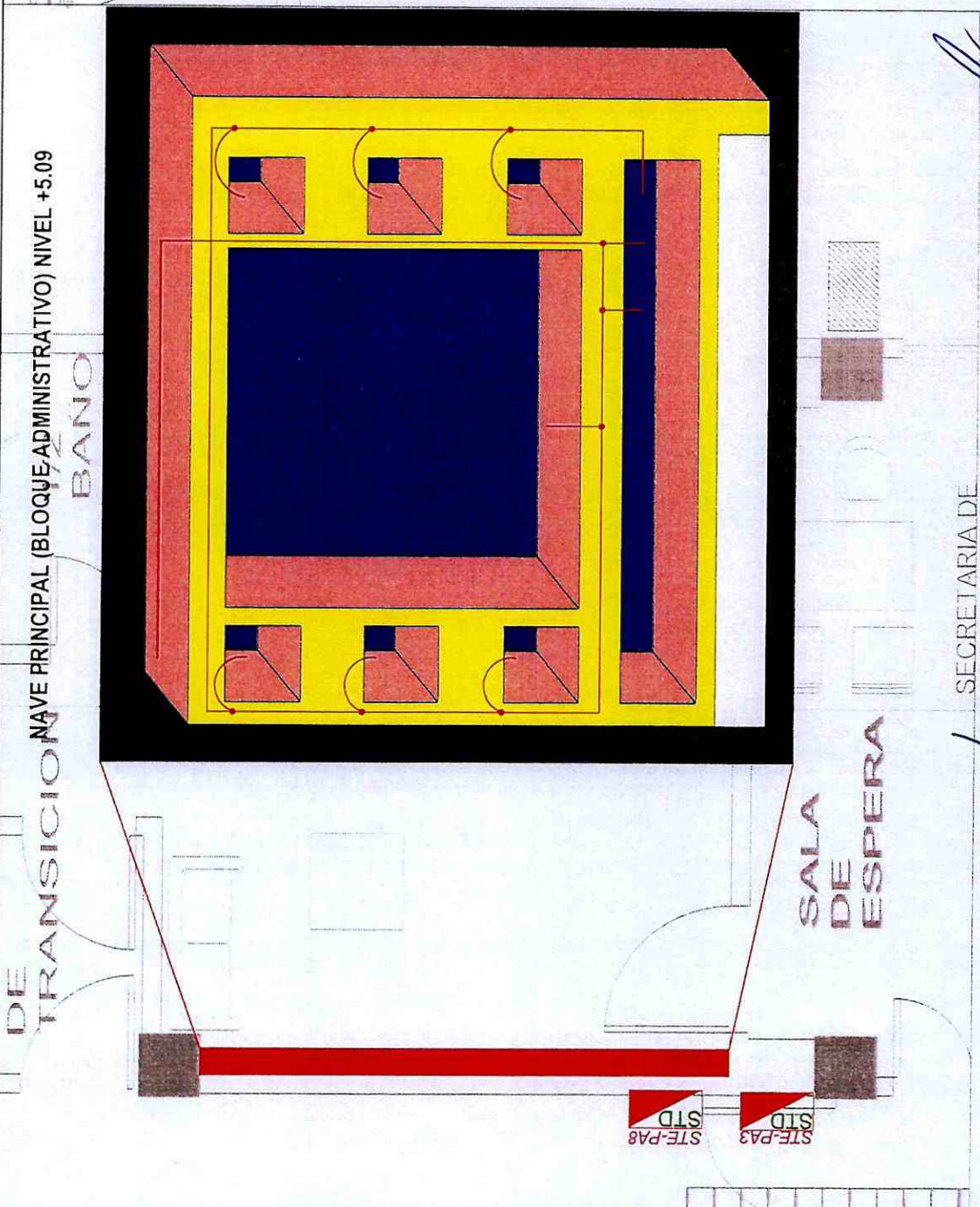
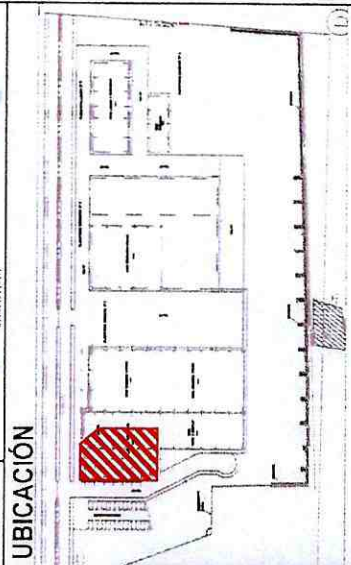

GOBIERNO AUTÓNOMO DESCENTRALIZADO DE LA PROVINCIA DEL PASTAZA

PROYECTO " CONSTRUCCIÓN DE LOS HANGARES DEL GOBIERNO AUTÓNOMO DESCENTRALIZADO PROVINCIAL DE PASTAZA (GADPPz) I ETAPA, PARROQUIA FÁTIMA, CANTÓN Y PROVINCIA DE PASTAZA "

PLANILLA DE AVANCE DE OBRA No. 23

RUBRO N° 366 ANEXO 1
 DESCRIPCIÓN: TENDIDO DE CABLE FLEXIBLE DE COBRE NO.12 AWG COLOR BLANCO (INC. TAYPE)
 UNIDAD: m
 PERIODO: 01-jun 30-jun



PAG. 1 DE 1

Descripción	Cantidad	Dimensión	Total	GRAFICO #
TENDIDO DE CABLE FLEXIBLE DE COBRE NO.12 AWG COLOR BLANCO (INC. TAYPE)	30,00		30,00	ANEXO 1
TOTAL:			30,00	

RESUMEN DE PLANILLA AL 100%					
DESCRIPCIÓN	CONTRATADO	ANTERIOR	ACTUAL	ACUMULADO	UNIDAD
TENDIDO DE CABLE FLEXIBLE DE COBRE NO.12 AWG COLOR BLANCO (INC. TAYPE)	1.200,00	945,00	30,00	875,00	m

_____ *[Signature]*
 CONTRATISTA

_____ *[Signature]*
 FISCALIZACIÓN

BIERNO AUTONOMO DESCENTRALIZADO DE LA PROVINCIA DEL PASTAZA

"CONSTRUCCIÓN DE LOS HANGARES DEL GOBIERNO AUTÓNOMO DESCENTRALIZADO PROVINCIAL DE PASTAZA (GADPP2) I ETAPA, PARROQUIA FÁTIMA, CANTÓN Y PROVINCIA DE PASTAZA "

RUBRO	366	ANEXO: 1
DESCRIPCION	TENDIDO DE CABLE FLEXIBLE DE COBRE NO.12 AWG COLOR BLANCO (INC. TAYPE)	
UNIDAD	m	
PERIODO	1 DE JUNIO 2021 A 30 DE JUNIO 2021	

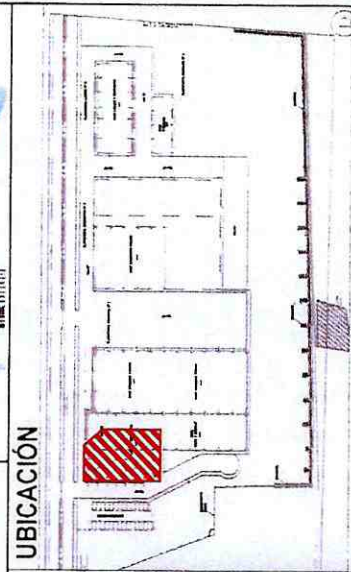

TRANSICION NAVE PRINCIPAL (BLOQUE ADMINISTRATIVO) NIVEL +5.09
BANO

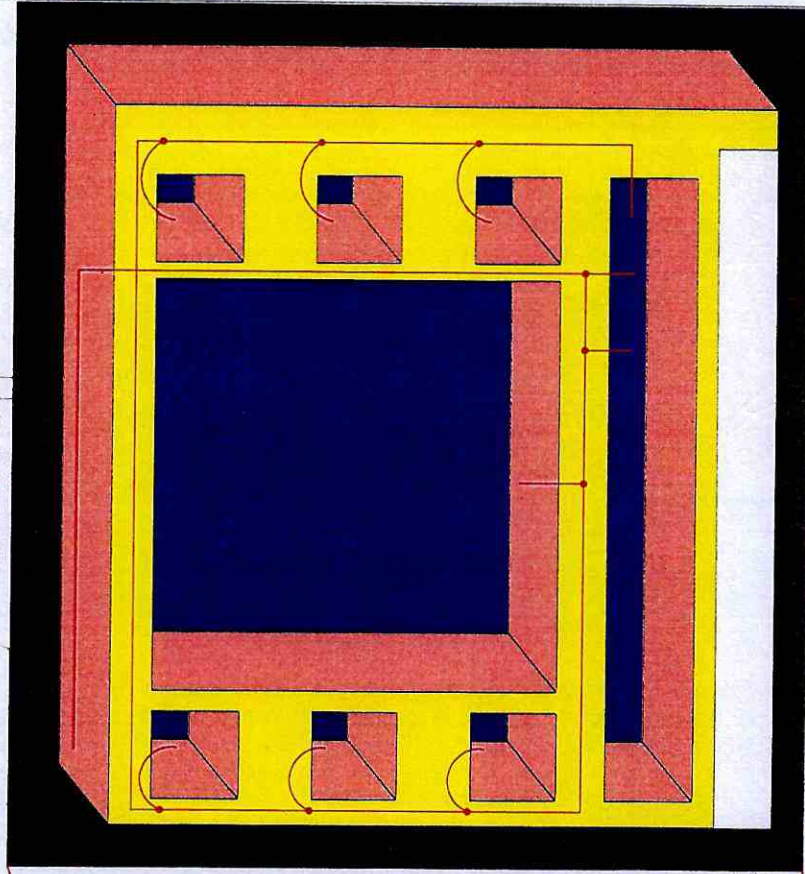

SALA DE ESPERA

SECRETARIA DE

CONTRATISTA

FISCALIZACIÓN

STD STE-PA8
 STD STE-PA3

GOBIERNO AUTÓNOMO DESCENTRALIZADO DE LA PROVINCIA DEL PASTAZA

PROYECTO "CONSTRUCCIÓN DE LOS HANGARES DEL GOBIERNO AUTÓNOMO DESCENTRALIZADO PROVINCIAL DE PASTAZA (GADPP2) | ETAPA, PARROQUIA FÁTIMA, CANTÓN Y PROVINCIA DE PASTAZA "

PLANILLA DE AVANCE DE OBRA No. 23

RUBRO N° 373 ANEXO 1
 DESCRIPCIÓN: TuBERIA EmT 1/2 PuLGADA
 UNIDAD: m
 PERIODO: 01-jun 30-jun



PAG. 1 DE 1

Descripción	Cantidad	Dimensión	Total	GRAFICO #
TuBERIA EmT 1/2 PuLGADA (TRAMO A - TERMOSTATOS ADMINISTRATIVO PA	2,94		2,94	ANEXO 1
TuBERIA EmT 1/2 PuLGADA (TRAMO B - TERMOSTATOS ADMINISTRATIVO PA	4,34		4,34	
TuBERIA EmT 1/2 PuLGADA (TRAMO C - TERMOSTATOS ADMINISTRATIVO PA	3,75		3,75	
TuBERIA EmT 1/2 PuLGADA (TRAMO D - TERMOSTATOS ADMINISTRATIVO PA	4,37		4,37	
TuBERIA EmT 1/2 PuLGADA (TRAMO E - TERMOSTATOS ADMINISTRATIVO PA	4,37		4,37	
TuBERIA EmT 1/2 PuLGADA (TRAMO F - TERMOSTATOS ADMINISTRATIVO PA	4,28		4,28	
TuBERIA EmT 1/2 PuLGADA (TRAMO G - TERMOSTATOS ADMINISTRATIVO PA	5,36		5,36	
TuBERIA EmT 1/2 PuLGADA (TRAMO H - TERMOSTATOS ADMINISTRATIVO PA	3,52		3,52	
TOTAL:			32,93	

RESUMEN DE PLANILLA AL 100%					
DESCRIPCION	CONTRATADO	ANTERIOR	ACTUAL	ACUMULADO	UNIDAD
TuBERIA EmT 1/2 PuLGADA	895.00	971,29	32.93	1 004,22	m

RESUMEN DE EXCEDENTES					
DESCRIPCION	CONTRATADO	ANTERIOR	ACTUAL	ACUMULADO	UNIDAD
TuBERIA EmT 1/2 PuLGADA	895.00	0.00	0,00	0,00	m

CONTRATISTA

FISCALIZACIÓN

**BIENIO AUTÓNOMO DESCENTRALIZADO DE LA
PROVINCIA DEL PASTAZA**

PROYECTO: * CONSTRUCCIÓN DE LOS HANGARES DEL GOBIERNO AUTÓNOMO DESCENTRALIZADO PROVINCIAL DE PASTAZA (GADPPZ) I ETAPA, PARROQUIA FÁTIMA, CANTÓN Y PROVINCIA DE PASTAZA *

RUBRO	373
DESCRIPCIÓN	TUBERIA EMT 1/2 PULGADA
UNIDAD	m
PERIODO	1 DE JUNIO 2021 A 30 DE JUNIO 2021

ANEXO: 1



UBICACIÓN

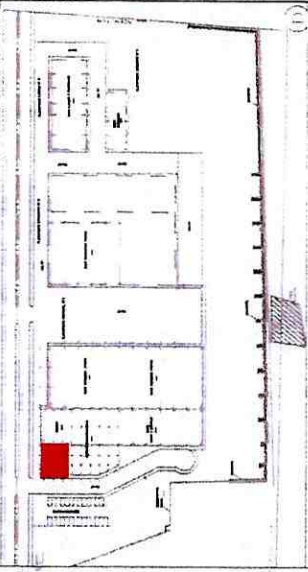

NAVE PRINCIPAL (BLOQUE ADMINISTRATIVO) NIVEL +5.09

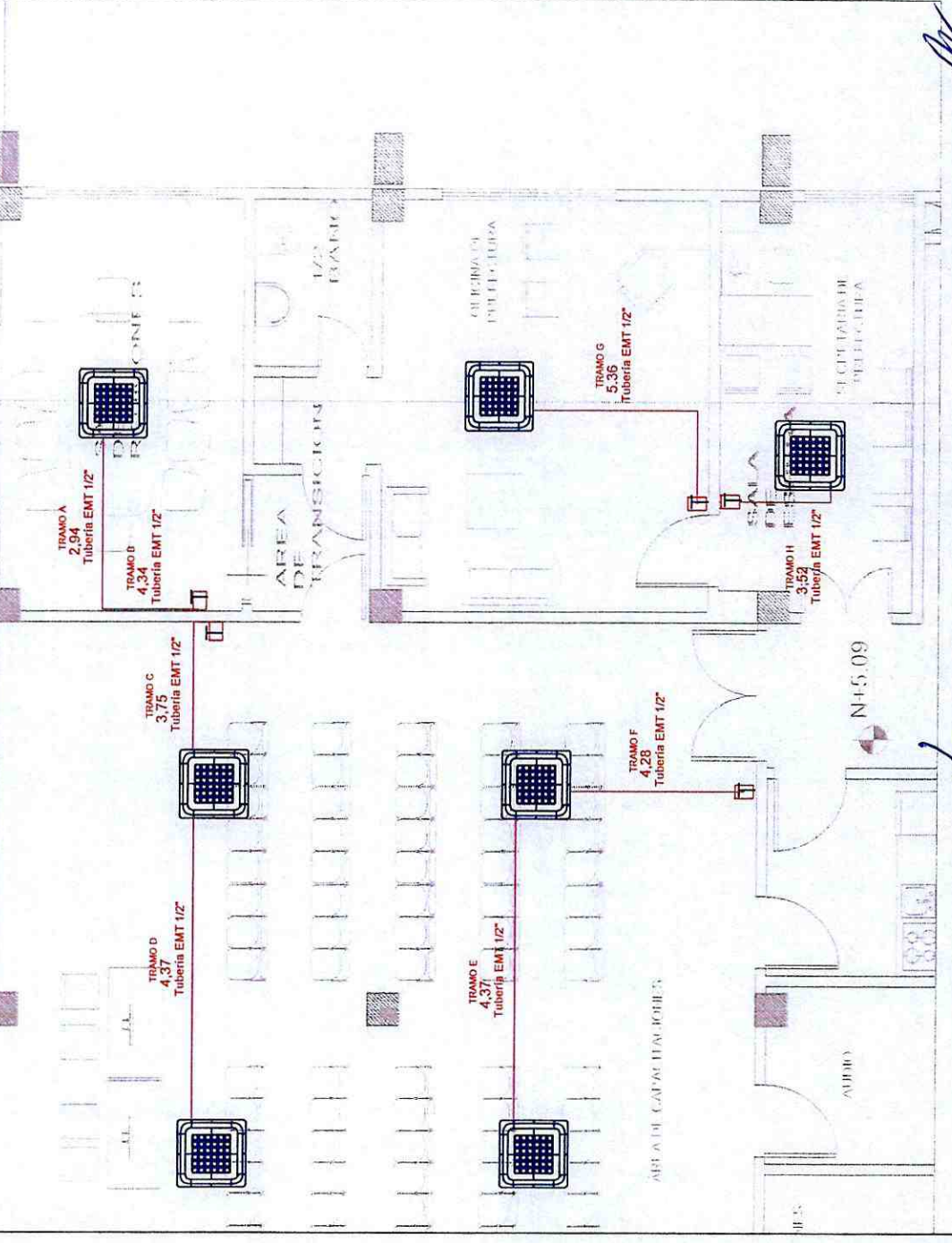

CONTRATISTA

FIRMA AUTORIZADA

GOBIERNO AUTÓNOMO DESCENTRALIZADO DE LA PROVINCIA DEL PASTAZA

PROYECTO " CONSTRUCCIÓN DE LOS HANGARES DEL GOBIERNO AUTÓNOMO DESCENTRALIZADO PROVINCIAL DE PASTAZA (GADPPz) I ETAPA, PARROQUIA FÁTIMA, CANTÓN Y PROVINCIA DE PASTAZA "

PLANILLA DE AVANCE DE OBRA No. 23

RUBRO N° 374 ANEXO 1
DESCRIPCION: uNION EmT 1/2 PuLGADA
UNIDAD: u
PERIODO: 01-jun 30-jun



PAG. 1 DE 1

Descripción	Cantidad	Dimensión	Total	GRAFICO #
uNION EmT 1/2 PuLGADA	18,00		18,00	ANEXO 1
TOTAL:			18,00	

RESUMEN DE PLANILLA AL 100%					
DESCRIPCION	300,00	256,00	ACTUAL	ACUMULADO	UNIDAD
uNION EmT 1/2 PuLGADA	300,00	256,00	18,00	274,00	u

CONTRATISTA



FISCALIZACIÓN

BIERNO AUTONOMO DESCENTRALIZADO DE LA
PROVINCIA DEL PASTAZA

PROYECTO:

" CONSTRUCCIÓN DE LOS HANGARES DEL GOBIERNO AUTÓNOMO DESCENTRALIZADO PROVINCIAL DE PASTAZA
(GADPPP) I ETAPA, PARROQUIA FÁTIMA, CANTÓN Y PROVINCIA DE PASTAZA "

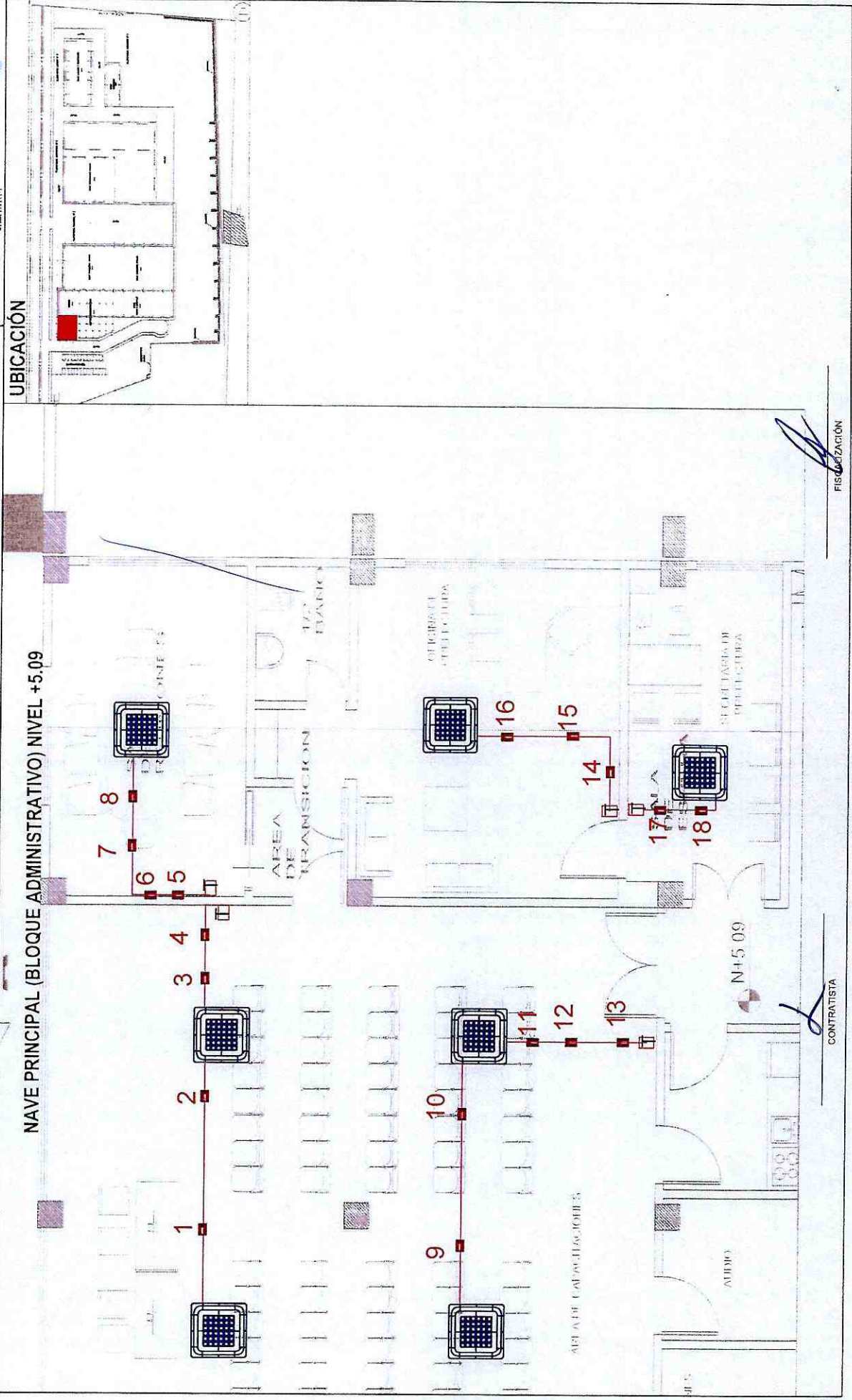
RUBRO	374	ANEXO: 1
DESCRIPCION	UNION EmT 1/2 PULGADA	
UNIDAD	U	
PERIODO	1 DE JUNIO 2021 A 30 DE JUNIO 2021	



UBICACIÓN

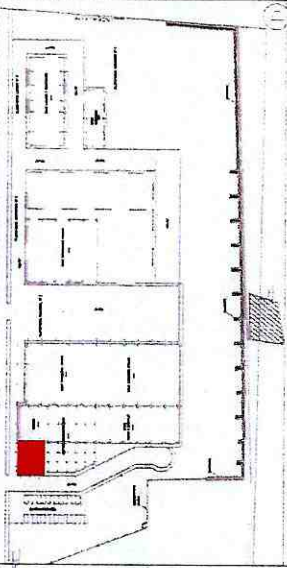

CONTRATISTA

FISCALIZACIÓN

BIERNO AUTONOMO DESCENTRALIZADO DE LA
PROVINCIA DEL PASTAZA

* CONSTRUCCIÓN DE LOS HANGARES DEL GOBIERNO AUTÓNOMO DESCENTRALIZADO PROVINCIAL DE PASTAZA
(GADPPZ) I ETAPA, PARROQUIA FÁTIMA, CANTÓN Y PROVINCIA DE PASTAZA *

RUBRO	375
DESCRIPCIÓN	CONECTOR EmT 1/2 Pul.GADA
UNIDAD	U
PERIODO	1 DE JUNIO 2021 A 30 DE JUNIO 2021

ANEXO: 1



UBICACIÓN

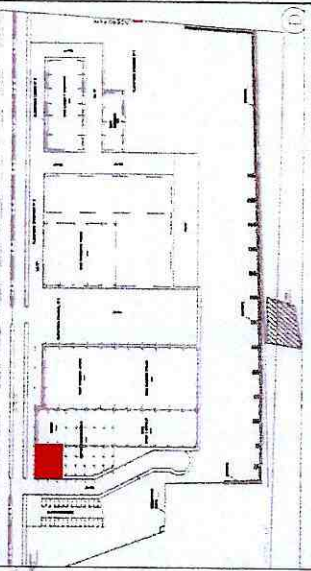

NAVE PRINCIPAL (BLOQUE ADMINISTRATIVO) NIVEL +5.09

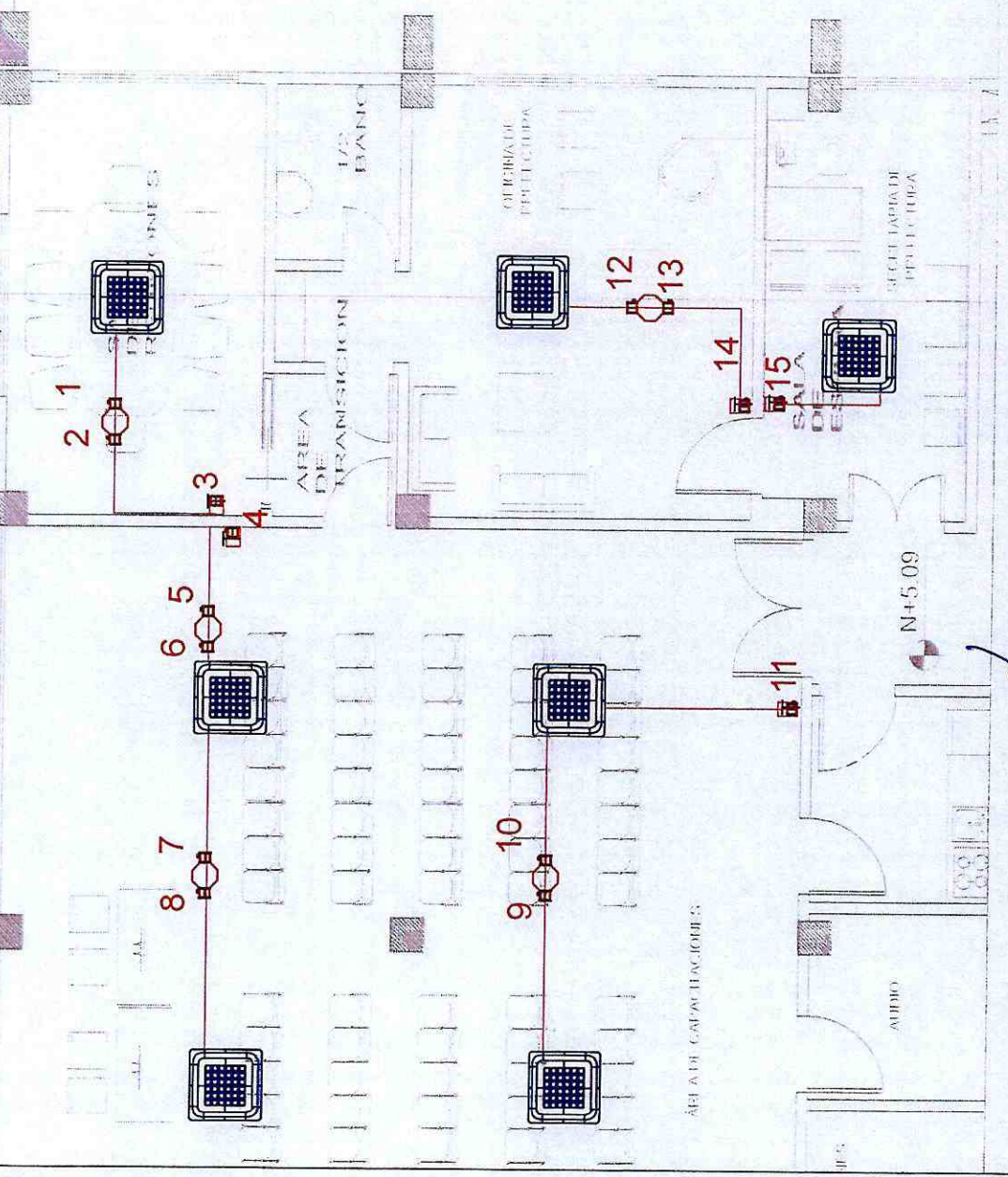

CONTRATISTA

FISCALIZACIÓN



PROYECTO " CONSTRUCCIÓN DE LOS HANGARES DEL GOBIERNO AUTÓNOMO DESCENTRALIZADO PROVINCIAL DE PASTAZA (GADPPz) I ETAPA, PARROQUIA FÁTIMA, CANTÓN Y PROVINCIA DE PASTAZA "

PLANILLA DE AVANCE DE OBRA No. 23

RUBRO N° 376 ANEXO 1
 DESCRIPCIÓN: FIJACION DE TUBOS EN LOZA CON GRAPA METALICA EmT 1/2 PULGADA
 UNIDAD: u
 PERIODO: 01-jun 30-jun



PAG. 1 DE 1

Descripción	Cantidad	Dimensión	Total	GRAFICO #
FIJACION DE TUBOS EN LOZA CON GRAPA METALICA EmT 1/2 PULGADA	16,00		16,00	ANEXO 1
TOTAL:			16,00	

RESUMEN DE PLANILLA AL 100%					
DESCRIPCION	400,00	228,00	ACTUAL	ACUMULADO	UNIDAD
FIJACION DE TUBOS EN LOZA CON GRAPA METALICA EmT 1/2 PULGADA	400,00	228,00	16,00	244,00	u

 CONTRATISTA

 FISCALIZACIÓN

BIERNO AUTONOMO DESCENTRALIZADO DE LA PROVINCIA DEL PASTAZA

"CONSTRUCCIÓN DE LOS HANGARES DEL GOBIERNO AUTÓNOMO DESCENTRALIZADO PROVINCIAL DE PASTAZA (GADPPZ) I ETAPA, PARROQUIA FÁTIMA, CANTÓN Y PROVINCIA DE PASTAZA"

PROYECTO:	ANEXO: 1
RUBRO	376
DESCRIPCIÓN	FIJACION DE TUBOS EN LOZA CON GRAPA METALICA EmT 1/2 Pul.GADA
UNIDAD	U
PERIODO	1 DE JUNIO 2021 A 30 DE JUNIO 2021

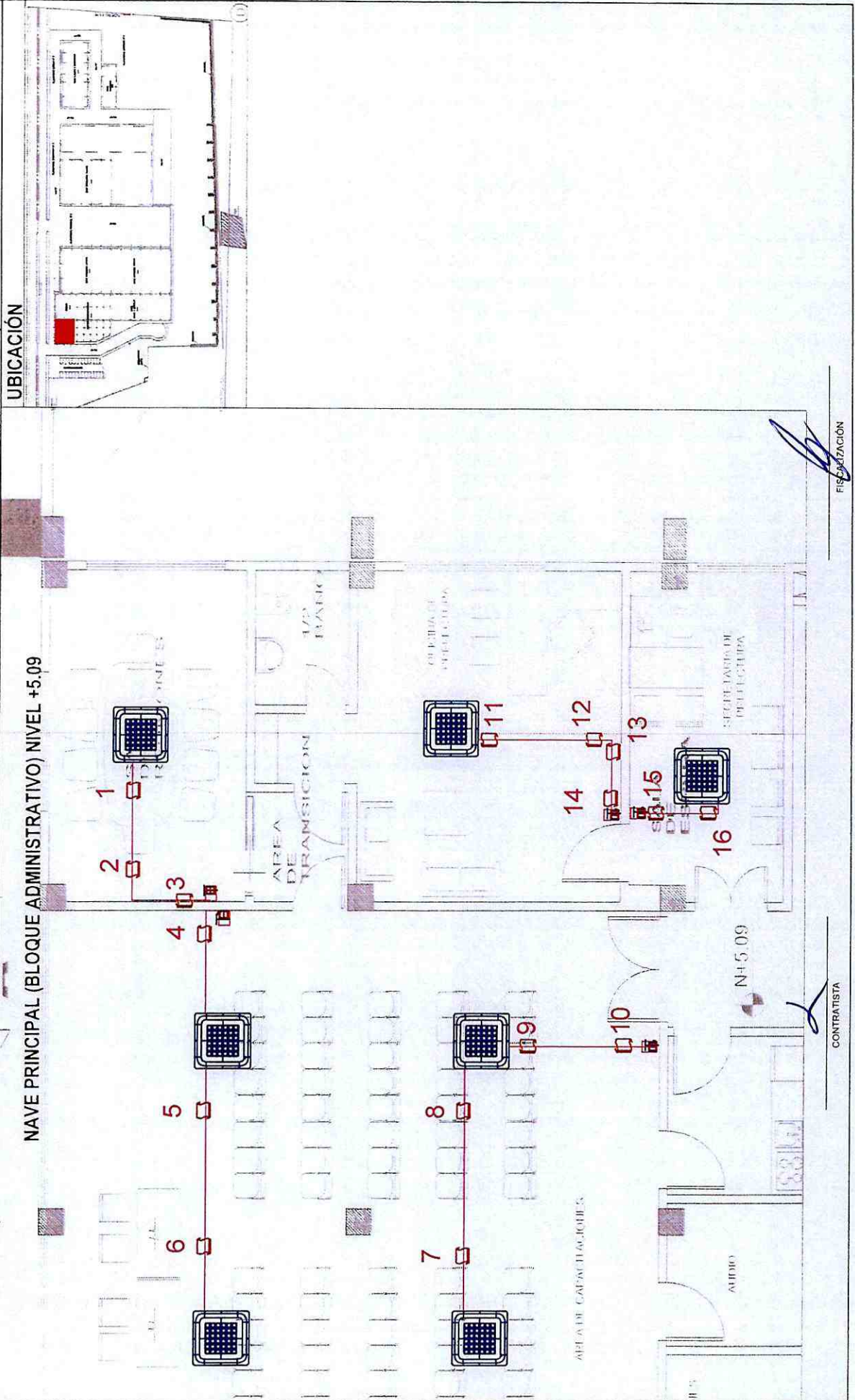

BIENIO AUTONOMO DESCENTRALIZADO DE LA
PROVINCIA DEL PASTAZA

"CONSTRUCCIÓN DE LOS HANGARES DEL GOBIERNO AUTÓNOMO DESCENTRALIZADO PROVINCIAL DE PASTAZA
(GADPPz) I ETAPA, PARROQUIA FÁTIMA, CANTÓN Y PROVINCIA DE PASTAZA"

RUBRO	380
DESCRIPCIÓN	CAJETINES METÁLICOS RECTANGULARES PROFUNDOS
UNIDAD	U
PERIODO	1 DE JUNIO 2021 A 30 DE JUNIO 2021

ANEXO: 1



UBICACIÓN

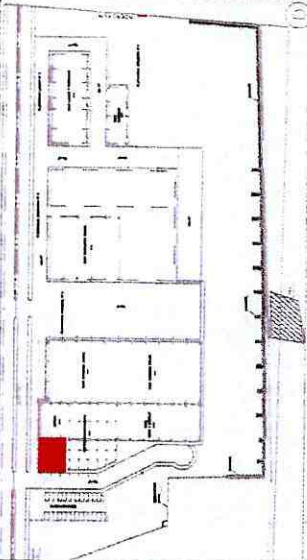

NAVE PRINCIPAL (BLOQUE ADMINISTRATIVO) NIVEL +5.09

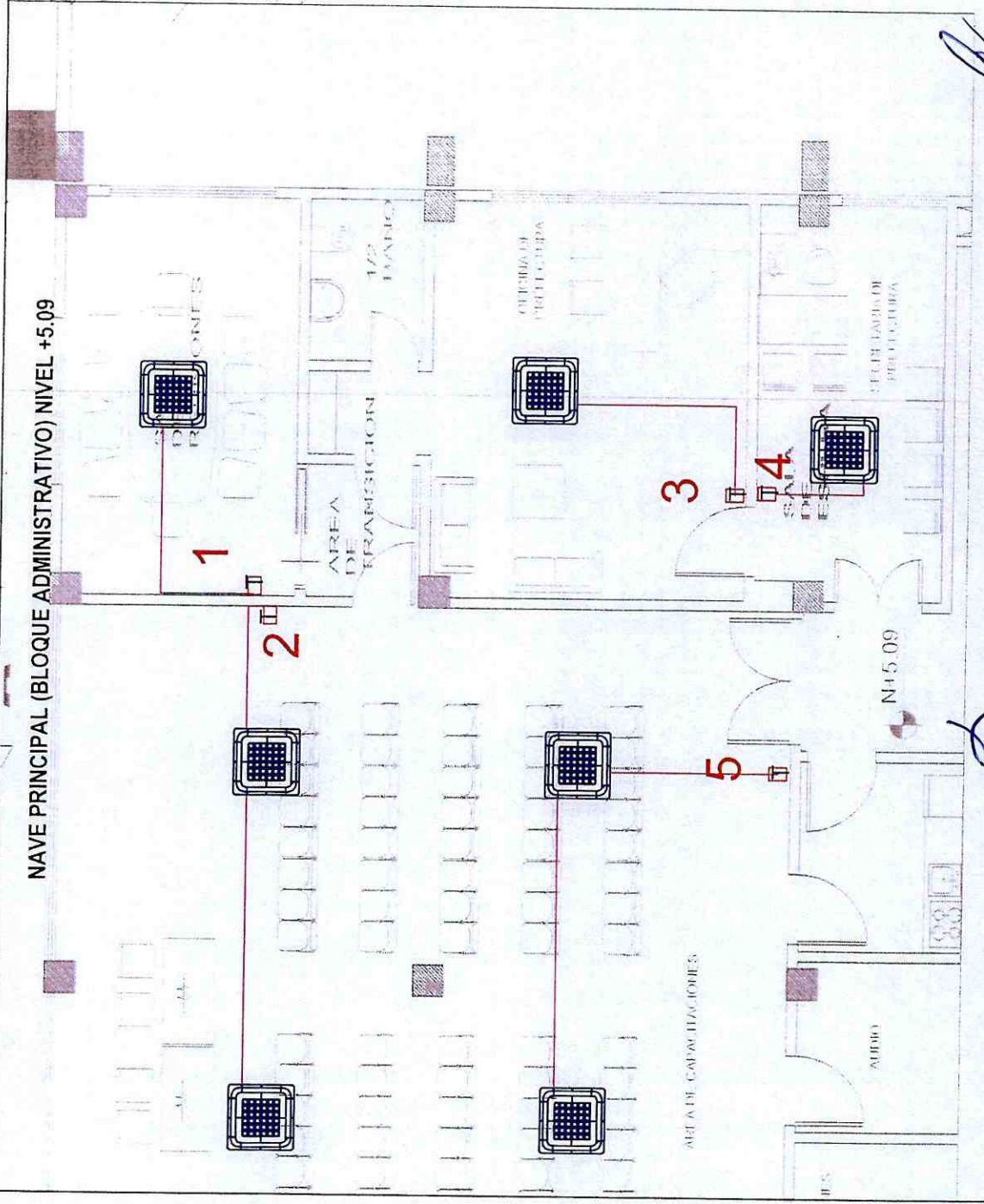

CONTRATISTA

FISCALIZACIÓN

**BIERNO AUTONOMO DESCENTRALIZADO DE LA
PROVINCIA DEL PASTAZA**

PROYECTO: " CONSTRUCCIÓN DE LOS HANGARES DEL GOBIERNO AUTÓNOMO DESCENTRALIZADO PROVINCIAL DE PASTAZA
(GADPPz) I ETAPA, PARROQUIA FÁTIMA, CANTÓN Y PROVINCIA DE PASTAZA "

RUBRO	414
DESCRIPCION	TENDIDO DE CABLE CONCENTRICO 2X12 AWG(INC. TAYPE)
UNIDAD	m
PERIODO	1 DE JUNIO 2021 A 30 DE JUNIO 2021

ANEXO: 1

UBICACIÓN

NAVE PRINCIPAL (BLOQUE ADMINISTRATIVO) NIVEL +5.09

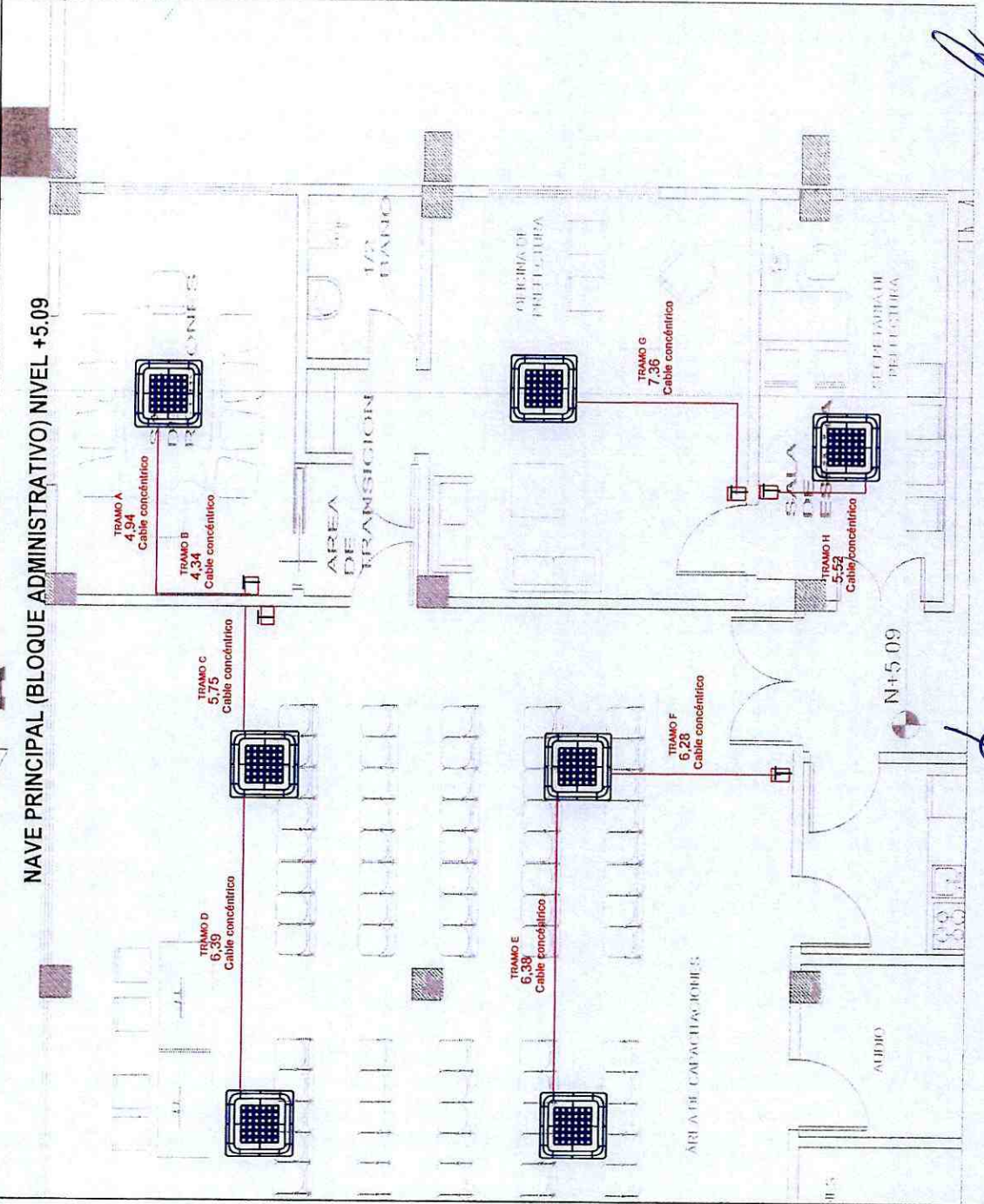
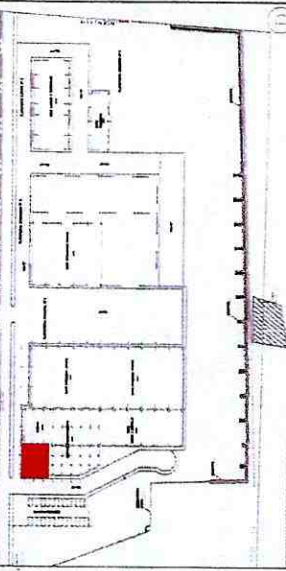

CONTRATISTA

REALIZACIÓN

GOBIERNO AUTÓNOMO DESCENTRALIZADO DE LA PROVINCIA DEL PASTAZA

PROYECTO "CONSTRUCCIÓN DE LOS HANGARES DEL GOBIERNO AUTÓNOMO DESCENTRALIZADO PROVINCIAL DE PASTAZA (GADPPz) I ETAPA, PARROQUIA FÁTIMA, CANTÓN Y PROVINCIA DE PASTAZA"

PLANILLA DE AVANCE DE OBRA No. 23

RUBRO N° 503 ANEXO 1
 DESCRIPCIÓN: TENDIDO DE CABLE NO. 3X6+6 Cu TW (INC. TAYPE)
 UNIDAD: m
 PERIODO: 01-jun 30-jun



PAG. 1 DE 1

Descripción	Cantidad	Dimensión	Total	GRAFICO #
TENDIDO DE CABLE NO. 3X6+6 Cu TW (INC. TAYPE) - TRAMO AA TDP ENGRASADO A STE A7	30,00		30,00	ANEXO 1
TENDIDO DE CABLE NO. 3X6+6 Cu TW (INC. TAYPE) - TRAMO CC TDP ENGRASADO A STE A3	12,00		12,00	
TOTAL:			42,00	

RESUMEN DE PLANILLA AL 100%					
DESCRIPCIÓN	CONTRATADO	ANTERIOR	ACTUAL	ACUMULADO	UNIDAD
TENDIDO DE CABLE NO. 3X6+6 Cu TW (INC. TAYPE)	41,00	20,50	21,50	42,00	m

RESUMEN DE PLANILLA DE INCREMENTOS						
DESCRIPCIÓN	CONTRATADO	ANTERIOR	ACTUAL	INCR. ANT.	INCR. ACT.	UNIDAD
TENDIDO DE CABLE NO. 3X6+6 Cu TW (INC. TAYPE)	41,00	20,50	0,00	0,00	20,50	m

 CONTRATISTA

 FISCALIZACIÓN

**BIENIO AUTONOMO DESCENTRALIZADO DE LA
PROVINCIA DEL PASTAZA**

* CONSTRUCCIÓN DE LOS HANGARES DEL GOBIERNO AUTÓNOMO DESCENTRALIZADO PROVINCIAL DE PASTAZA
(GADPPZ) | ETAPA, PARROQUIA FÁTIMA, CANTÓN Y PROVINCIA DE PASTAZA *

ANEXO: 1

503

TENDIDO DE CABLE NO. 3X6+6 Cu TW (INC. TAYPE)

m

1 DE JUNIO 2021 A 30 DE JUNIO 2021

PROYECTO:

RUBRO

DESCRIPCION

UNIDAD

PERIODO

UBICACIÓN

BLOQUE ENGRASADO (HANGAR LAVADO Y ENGRASADO) NIVEL +0.30

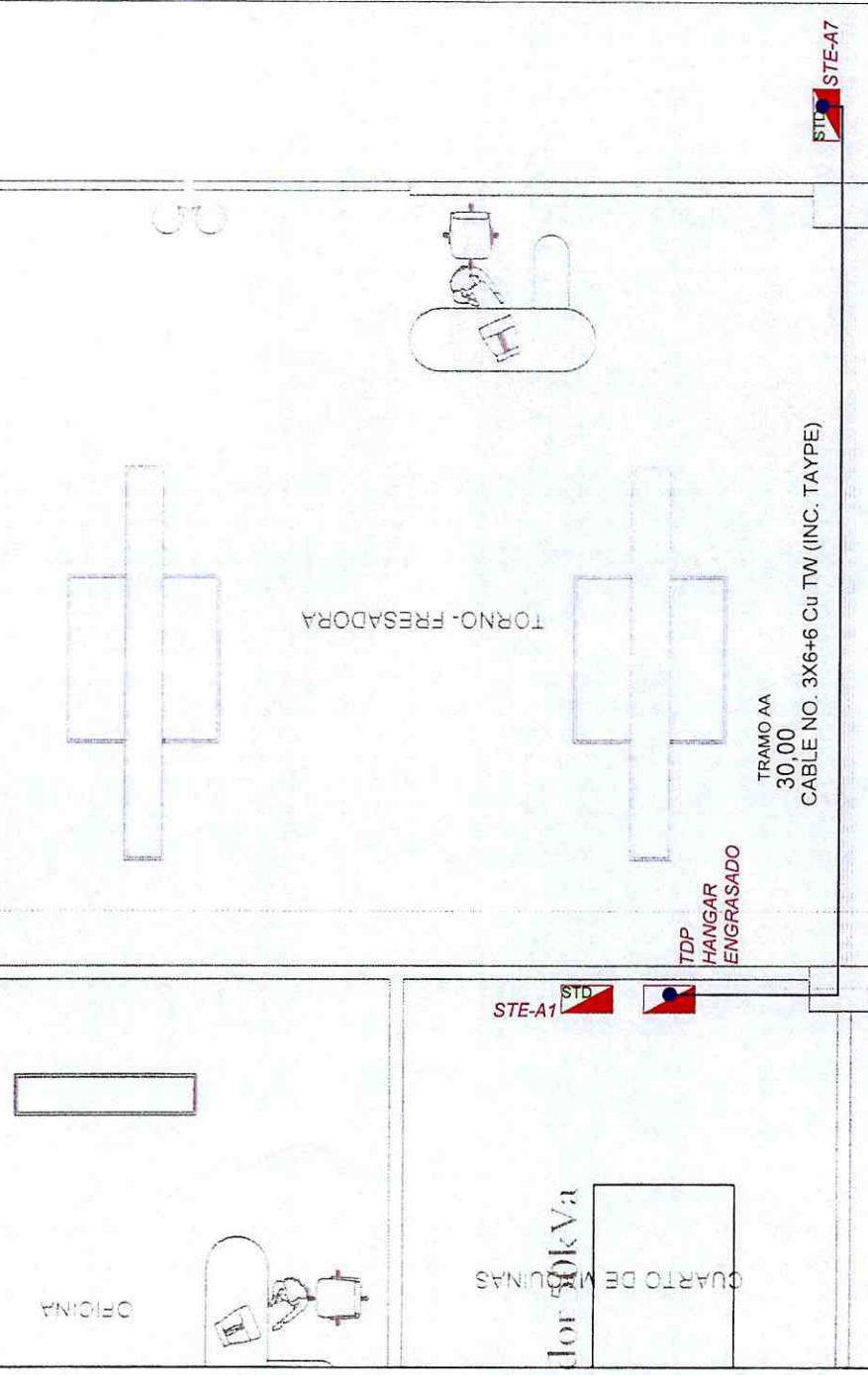
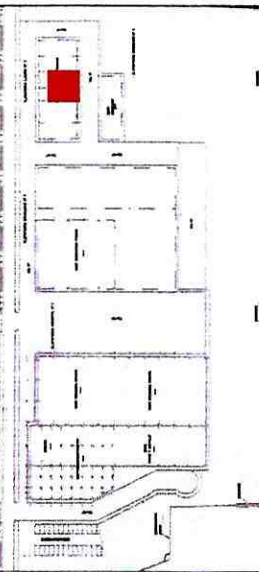

[Signature]
FISCALIZACIÓN

[Signature]
CONTRATISTA

BIERNO AUTONOMO DESCENTRALIZADO DE LA
PROVINCIA DEL PASTAZA

" CONSTRUCCIÓN DE LOS HANGARES DEL GOBIERNO AUTONOMO DESCENTRALIZADO PROVINCIAL DE PASTAZA
(GADPPZ) I ETAPA, PARROQUIA FÁTIMA, CANTÓN Y PROVINCIA DE PASTAZA "



ANEXO: 1

RUBRO 503
DESCRIPCION TENDIDO DE CABLE NO. 3X6+6 Cu TW (INC. TAYPE)
UNIDAD m

PERIODO 1 DE JUNIO 2021 A 30 DE JUNIO 2021

UBICACIÓN

BLOQUE ENGRASADO (HANGAR LAVADO Y ENGRASADO) NIVEL +0.30

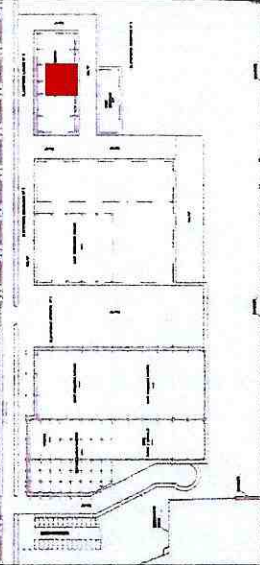

CUARTO DE MQUINAS

Transformador 50kVa

TRAMO CC
12,00
CABLE NO. 3X6+6 Cu TW (INC. TAYPE)

STE-A1

STD

TDP

HANGAR
ENGRASADO

[Signature]
CONTRATISTA

[Signature]
FISCALIZACIÓN

BIENIO AUTÓNOMO DESCENTRALIZADO DE LA
PROVINCIA DEL PASTAZA

* CONSTRUCCIÓN DE LOS HANGARES DEL GOBIERNO AUTÓNOMO DESCENTRALIZADO PROVINCIAL DE PASTAZA
(GADPPP) I ETAPA. PARROQUIA FÁTIMA, CANTÓN Y PROVINCIA DE PASTAZA *

RUBRO	516	ANEXO: 1
DESCRIPCION	TENDIDO DE CABLE DE COBRE NO. 1/0 THHN	
UNIDAD	m	
PERIODO	1 DE JUNIO 2021 A 30 DE JUNIO 2021	

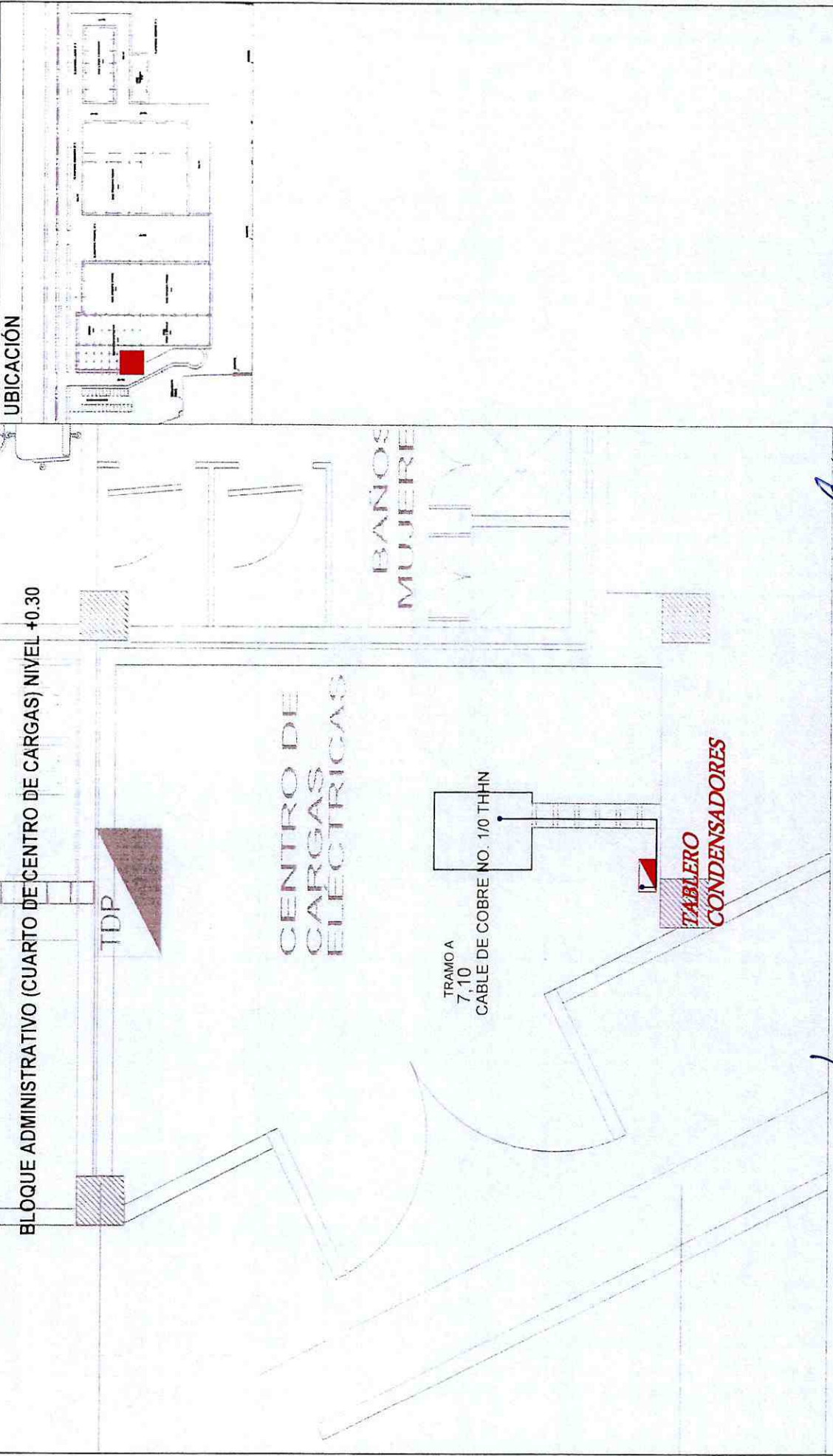

UBICACIÓN

CONTRATISTA

ESCALIZACIÓN

BIENIO AUTÓNOMO DESCENTRALIZADO DE LA
PROVINCIA DEL PASTAZA

" CONSTRUCCIÓN DE LOS HANGARES DEL GOBIERNO AUTÓNOMO DESCENTRALIZADO PROVINCIAL DE PASTAZA
(GADPPz) I ETAPA, PARROQUIA FÁTIMA, CANTÓN Y PROVINCIA DE PASTAZA "

RUBRO	516	ANEXO: 1
DESCRIPCIÓN	TENDIDO DE CABLE DE COBRE NO. 1/0 THHN	
UNIDAD	m	
PERIODO	1 DE JUNIO 2021 A 30 DE JUNIO 2021	

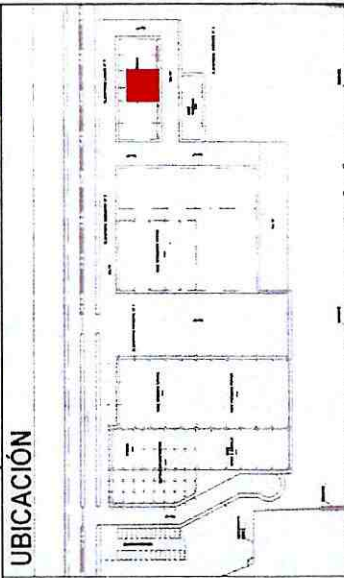

UBICACIÓN

BLOQUE ENGRASADO (HANGAR LAVADO Y ENGRASADO) NIVEL +0.30

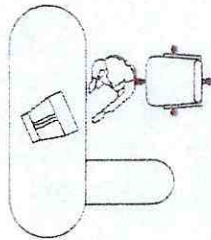

TORNO-FRESADORA

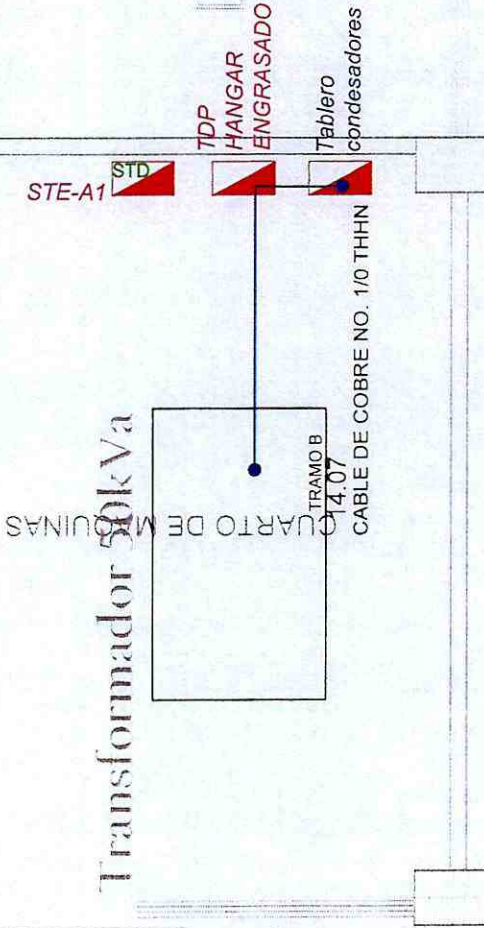

FISCALIZACIÓN

CONTRATISTA

PROYECTO

" CONSTRUCCIÓN DE LOS HANGARES DEL GOBIERNO AUTÓNOMO DESCENTRALIZADO PROVINCIAL DE PASTAZA (GADPP) I ETAPA, PARROQUIA FÁTIMA, CANTÓN Y PROVINCIA DE PASTAZA "

PLANILLA DE AVANCE DE OBRA No. 23

RUBRO N° 523

ANEXO 1

DESCRIPCIÓN: INSTALACION DE CENTRAL ENERGIZADORA 5K

UNIDAD: u

PERIODO: 01-jun 30-jun



PAG. 1 DE 1

Descripción	Cantidad	Dimensión	Total	GRAFICO #
INSTALACION DE CENTRAL ENERGIZADORA 5K	1,00		1,00	ANEXO 1
TOTAL:			1,00	

RESUMEN DE PLANILLA AL 100%					
DESCRIPCIÓN	CONTRATADO	ANTERIOR	ACTUAL	ACUMULADO	UNIDAD
INSTALACION DE CENTRAL ENERGIZADORA 5K	0,00		1,00	1,00	u

_____ CONTRATISTA

_____ FISCALIZACIÓN

**BIERNO AUTONOMO DESCENTRALIZADO DE LA
PROVINCIA DEL PASTAZA**

" CONSTRUCCIÓN DE LOS HANGARES DEL GOBIERNO AUTÓNOMO DESCENTRALIZADO PROVINCIAL DE PASTAZA
(GADPPP) I ETAPA, PARROQUIA FÁTIMA, CANTÓN Y PROVINCIA DE PASTAZA "

RUBRO	523	ANEXO: 1
DESCRIPCION	INSTALACION DE CENTRAL ENERGIZADORA 5K	
UNIDAD	U	
PERIODO	1 DE JUNIO 2021 A 30 DE JUNIO 2021	



UBICACIÓN

**ELIGRO
ERCO**

CERRAMIENTO - LINDERO NIVEL +0,30

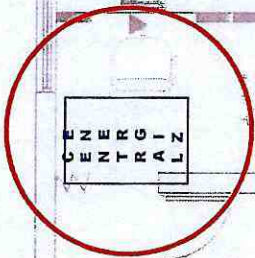
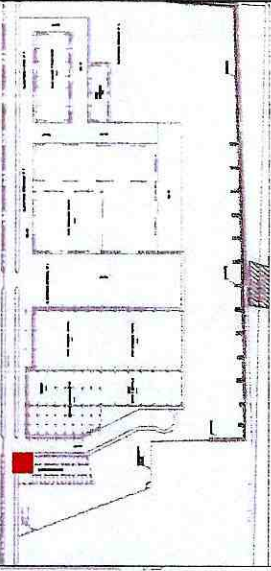

CENTRALIZ

6E STEGRT1

CONTRATISTA

ESPECIALIZACIÓN

**BIERNO AUTONOMO DESCENTRALIZADO DE LA
PROVINCIA DEL PASTAZA**

"CONSTRUCCIÓN DE LOS HANGARES DEL GOBIERNO AUTÓNOMO DESCENTRALIZADO PROVINCIAL DE PASTAZA
(GADPPZ) I ETAPA, PARROQUIA FÁTIMA, CANTÓN Y PROVINCIA DE PASTAZA "

ANEXO: 1/2

RUBRO	524
DESCRIPCION	COLOCACION DE TUBERIA PREPARADA
UNIDAD	U
PERIODO	1 DE JUNIO 2021 A 30 DE JUNIO 2021

UBICACIÓN

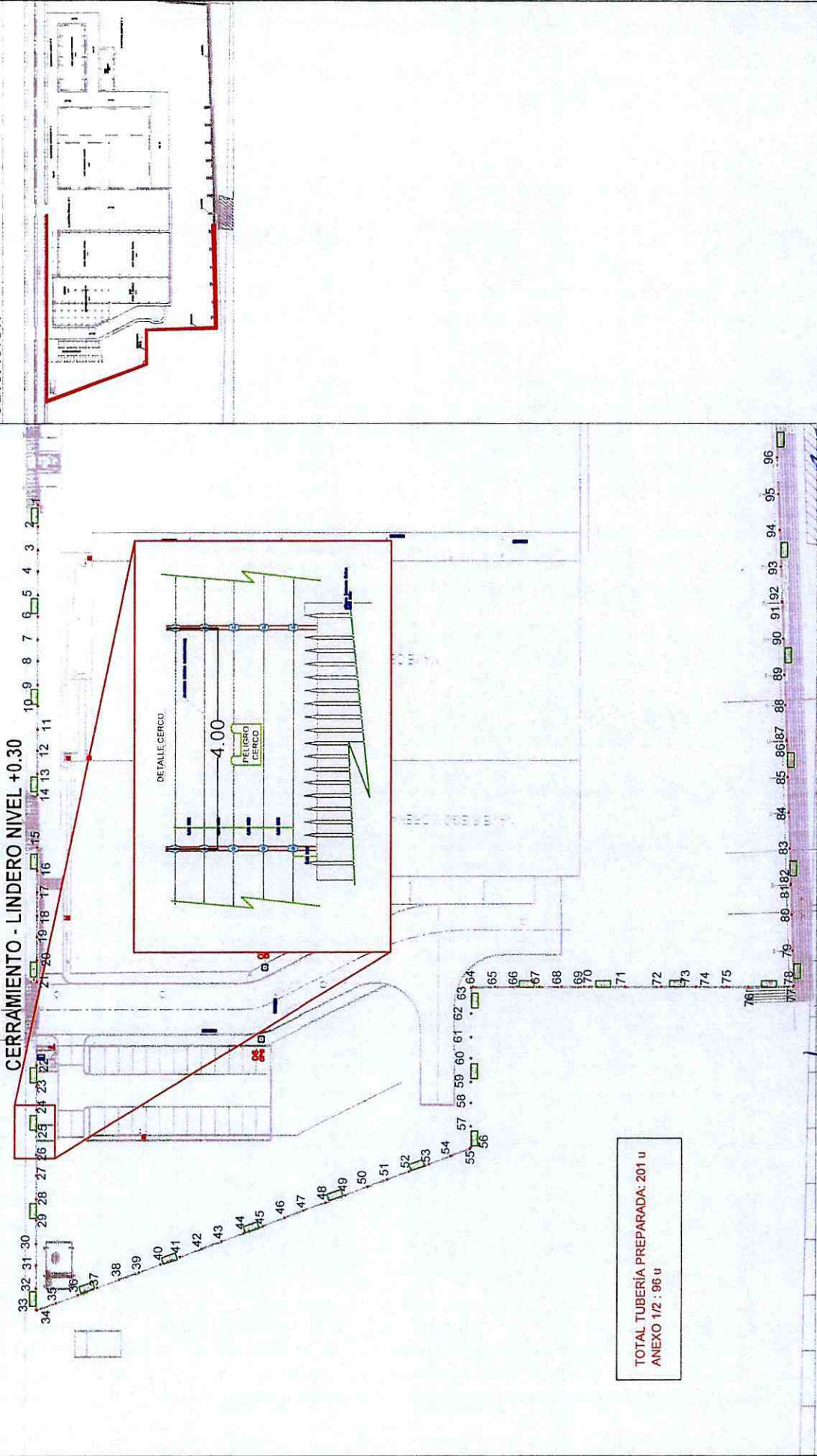

TOTAL TUBERÍA PREPARADA: 201 u
ANEXO 1/2 : 96 u

CONTRATISTA

FIGURACIÓN

**BIERNO AUTONOMO DESCENTRALIZADO DE LA
PROVINCIA DEL PASTAZA**

* CONSTRUCCIÓN DE LOS HANGARES DEL GOBIERNO AUTÓNOMO DESCENTRALIZADO PROVINCIAL DE PASTAZA
(GADPPZ) I ETAPA, PARROQUIA FÁTIMA, CANTÓN Y PROVINCIA DE PASTAZA *



ANEXO: 2/2

RUBRO	524
DESCRIPCION	COLOCACION DE TUBERIA PREPARADA
UNIDAD	u
PERIODO	1 DE JUNIO 2021 A 30 DE JUNIO 2021

UBICACIÓN

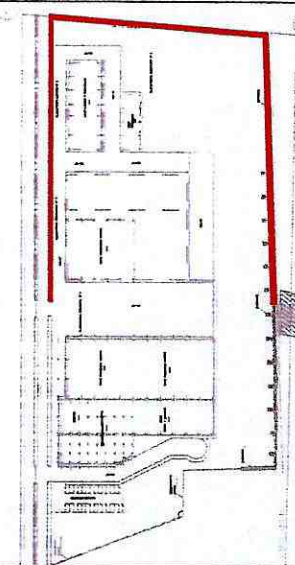

CERRAMIENTO - LINDERO NIVEL +0.30

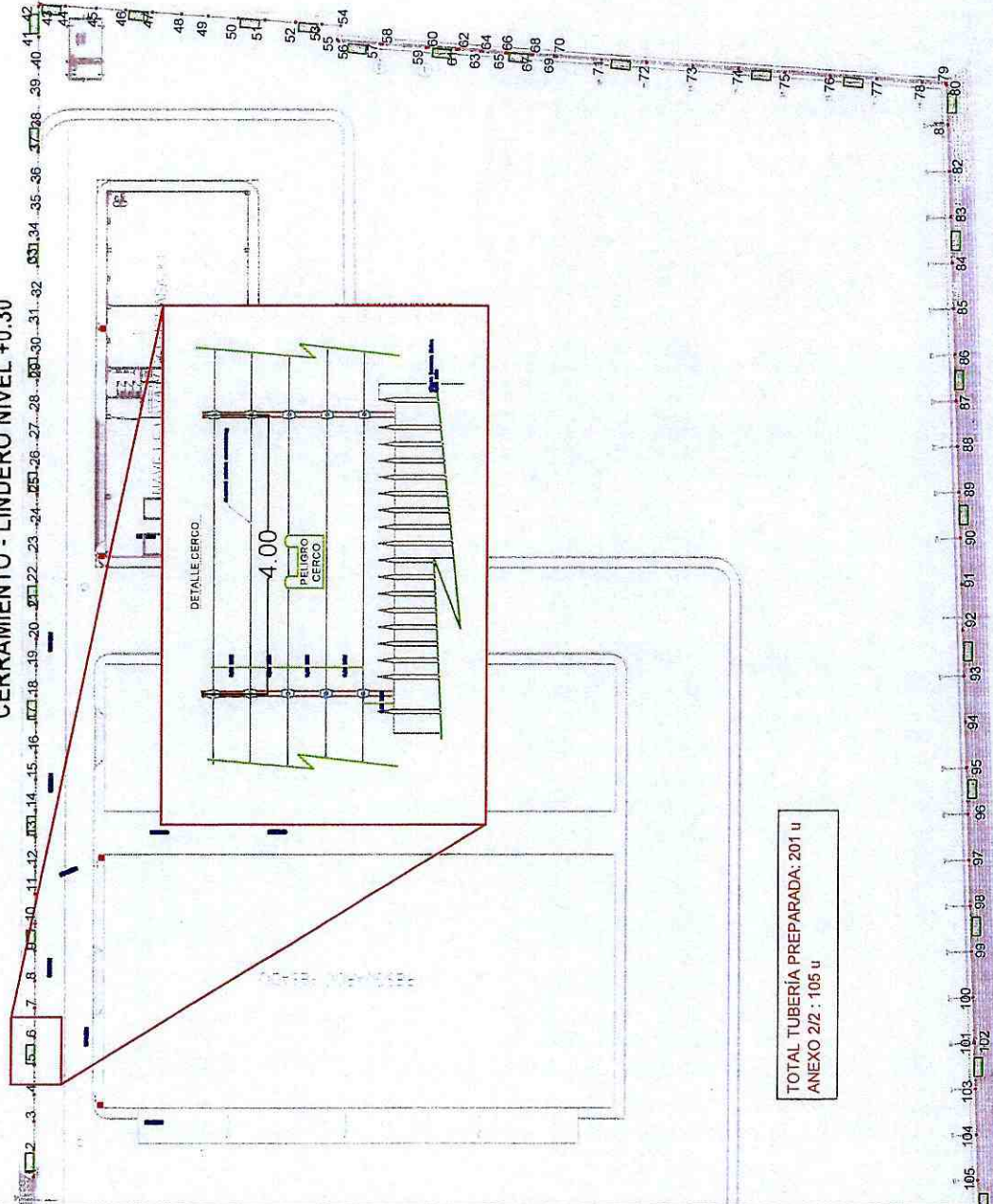

TOTAL TUBERÍA PREPARADA: 201 u
ANEXO 2/2 : 105 u

CONTRATISTA

FISCALIA

GOBIERNO AUTÓNOMO DESCENTRALIZADO DE LA PROVINCIA DEL PASTAZA

PROYECTO

" CONSTRUCCION DE LOS HANGARES DEL GOBIERNO AUTONOMO DESCENTRALIZADO PROVINCIAL DE PASTAZA (GADPPz) I ETAPA, PARROQUIA FÁTIMA, CANTÓN Y PROVINCIA DE PASTAZA "

PLANILLA DE AVANCE DE OBRA No. 23

RUBRO N° 525 ANEXO 1

DESCRIPCION: COLOCACION DE AISLADORES DE PASO DE ESQUINA Y PASANTE

UNIDAD: u

PERIODO: 01-jun 30-jun



PAG. 1 DE 1

Descripción	Cantidad	Dimensión	Total	GRAFICO #
COLOCACION DE AISLADORES DE PASO DE ESQUINA Y PASANTE	1205,00		1205,00	ANEXO 1
TOTAL:			1.205,00	

RESUMEN DE PLANILLA AL 100%					
DESCRIPCION	CONTRATADO	ANTERIOR	ACTUAL	ACUMULADO	UNIDAD
COLOCACION DE AISLADORES DE PASO DE ESQUINA Y PASANTE	0,00	-	1.205,00	1.205,00	u

CONTRATISTA

ESCALIZACIÓN

**BIERNO AUTONOMO DESCENTRALIZADO DE LA
PROVINCIA DEL PASTAZA**

" CONSTRUCCIÓN DE LOS HANGARES DEL GOBIERNO AUTÓNOMO DESCENTRALIZADO PROVINCIAL DE PASTAZA
(GADPPz) I ETAPA, PARROQUIA FÁTIMA, CANTÓN Y PROVINCIA DE PASTAZA "

PROYECTO:	
RUBRO	525
DESCRIPCION	COLOCACION DE AISLADORES DE PASE DE ESQUINA Y PASANTE
UNIDAD	U
PERIODO	1 DE JUNIO 2021 A 30 DE JUNIO 2021
ANEJO:	1



CERRAMIENTO - LINDERO NIVEL +0.30

UBICACIÓN

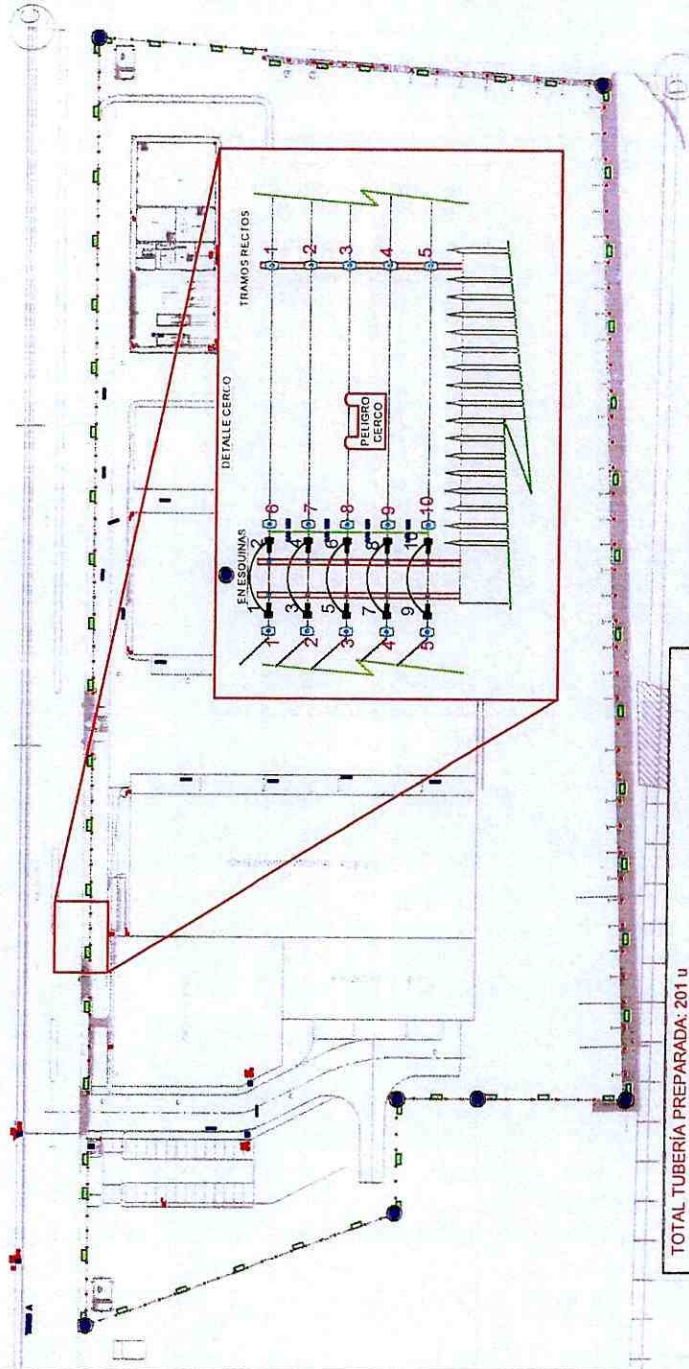
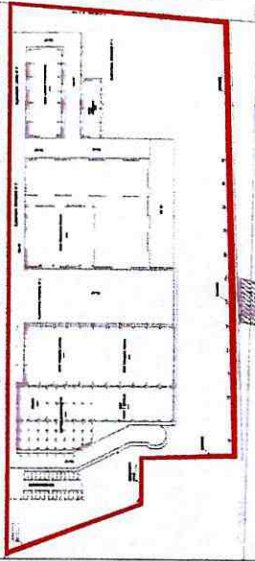

TOTAL TUBERÍA PREPARADA:	201 u
TUBERÍA EN TRAMOS RECTOS:	187 u
AISLADOR PASANTE:	5 u x CTUBO (161)
AISLADOR DE PASE Y PASANE EN DESNIVEL:	10 x CTUBO (26)
TUBERÍA EN ESQUINAS:	14 u
AISLADOR PASANTE:	5 u x CTUBO
AISLADOR DE PASE DE ESQUINA:	5 u x CTUBO
TOTAL AISLADORES PASANTES:	1005 u
TOTAL AISLADORES DE PASE DE ESQUINA:	200 u

 CONTRATISTA

FISCALIZACIÓN

PROYECTO " CONSTRUCCIÓN DE LOS HANGARES DEL GOBIERNO AUTÓNOMO DESCENTRALIZADO PROVINCIAL DE PASTAZA (GADPPz) I ETAPA, PARROQUIA FÁTIMA, CANTÓN Y PROVINCIA DE PASTAZA "

PLANILLA DE AVANCE DE OBRA No. 23

RUBRO N° 526 ANEXO 1
 DESCRIPCIÓN: TENDIDO DE ALAMBRE SOLIDO GALVANIZADO
 UNIDAD: m
 PERIODO: 01-jun 30-jun



PAG. 1 DE 1

Descripción	Cantidad	Dimensión	Total	GRAFICO #
TENDIDO DE ALAMBRE SOLIDO GALVANIZADO (TRAMO A)	323,57	5	1617,85	ANEXO 1
TENDIDO DE ALAMBRE SOLIDO GALVANIZADO (TRAMO B)	42,32	5	211,60	
TENDIDO DE ALAMBRE SOLIDO GALVANIZADO (TRAMO C)	86,19	5	430,95	
TENDIDO DE ALAMBRE SOLIDO GALVANIZADO (TRAMO D)	255,08	5	1275,40	
TENDIDO DE ALAMBRE SOLIDO GALVANIZADO (TRAMO E)	37,55	5	187,75	
TENDIDO DE ALAMBRE SOLIDO GALVANIZADO (TRAMO F)	20,00	5	100,00	
TENDIDO DE ALAMBRE SOLIDO GALVANIZADO (TRAMO G)	28,59	5	142,95	
TENDIDO DE ALAMBRE SOLIDO GALVANIZADO (TRAMO H)	83,58	5	417,90	
TENDIDO DE ALAMBRE SOLIDO GALVANIZADO (TENDIDO EN ESQUINA)	140		140,00	
TENDIDO DE ALAMBRE SOLIDO GALVANIZADO (TENDIDO EN DESNIVEL)	260,00		260,00	
TOTAL:			4.784,40	

RESUMEN DE PLANILLA AL 100%					
DESCRIPCION	0,00	0,00	ACTUAL	ACUMULADO	UNIDAD
TENDIDO DE ALAMBRE SOLIDO GALVANIZADO	0,00	-	4.784,40	4.784,40	m

 CONTRATISTA

 FISCALIZACIÓN

PROYECTO: " CONSTRUCCIÓN DE LOS HANGARES DEL GOBIERNO AUTÓNOMO DESCENTRALIZADO PROVINCIAL DE PASTAZA
(GADPPz) I ETAPA, PARROQUIA FÁTIMA, CANTÓN Y PROVINCIA DE PASTAZA "

RUBRO	526
DESCRIPCION	TENDIDO DE ALAMBRE SOLIDO GALVANIZADO
UNIDAD	m
PERIODO	1 DE JUNIO 2021 A 30 DE JUNIO 2021

ANEXO: 1



UBICACIÓN

CERRAMIENTO - LINDERO NIVEL +0.30

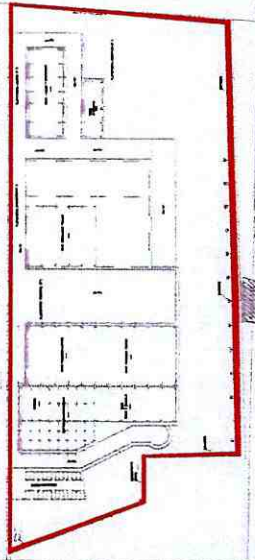

TRAMO A
323.57

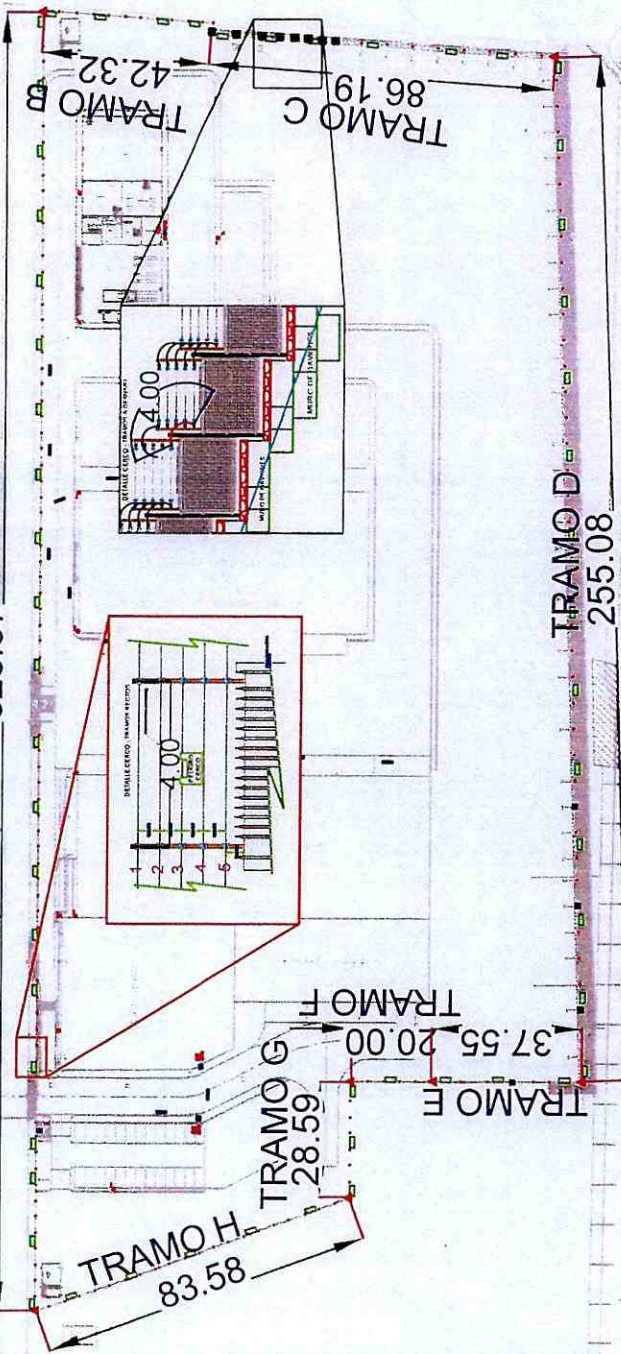

TOTAL PERÍMETRO: 876.88 m
 ▲ CRUCE CURVA EN ESQUINA: 5h x 4m: 20 m
 ■ DETALLE CERCO A DESNIVEL: 5h x 4m: 20 m

TOTAL METRAJE= 5x(PERÍMETRO TOTAL) + (nCRUCE CURVA) + (nCERCO A DESNIVEL)
 = 5x(876.88m) + (20mx7) + (20mx3)
 = 4384.40m + 140m + 260m
 = **4784.40 metros.**

[Signature]
FISCALIZACIÓN

[Signature]
CONTRATISTA

PROYECTO " CONSTRUCCIÓN DE LOS HANGARES DEL GOBIERNO AUTÓNOMO DESCENTRALIZADO PROVINCIAL DE PASTAZA (GADPP); I ETAPA, PARROQUIA FÁTIMA, CANTÓN Y PROVINCIA DE PASTAZA "

PLANILLA DE AVANCE DE OBRA No. 23

RUBRO N° 527 ANEXO 1
 DESCRIPCIÓN: TENDIDO DE CONDUCTOR DE COBRE DE ALTA TENSION 1/0
 UNIDAD: m
 PERIODO: 01-jun 30-jun



PAG. 1 DE 1

Descripción	Cantidad	Dimensión	Total	GRAFICO #
TENDIDO DE CONDUCTOR DE COBRE DE ALTA TENSION 1/0 (TRAMO A)	2,20		2,20	ANEXO 1
TENDIDO DE CONDUCTOR DE COBRE DE ALTA TENSION 1/0 (TRAMO B)	2,70		2,70	
TENDIDO DE CONDUCTOR DE COBRE DE ALTA TENSION 1/0 (TRAMO C)	4,00		4,00	
TENDIDO DE CONDUCTOR DE COBRE DE ALTA TENSION 1/0 (TRAMO D)	1,50		1,50	
TENDIDO DE CONDUCTOR DE COBRE DE ALTA TENSION 1/0 (TRAMO E)	1,20		1,20	
TOTAL:			11,60	

RESUMEN DE PLANILLA AL 100%					
DESCRIPCIÓN	CONTRATADO	ANTERIOR	ACTUAL	ACUMULADO	UNIDAD
TENDIDO DE CONDUCTOR DE COBRE DE ALTA TENSION 1/0	0,00		11,60	11,60	m



 CONTRATISTA



 FISCALIZACIÓN

BIERNO AUTONOMO DESCENTRALIZADO DE LA
PROVINCIA DEL PASTAZA

" CONSTRUCCIÓN DE LOS HANGARES DEL GOBIERNO AUTÓNOMO DESCENTRALIZADO PROVINCIAL DE PASTAZA
(GADPPz) I ETAPA, PARROQUIA FÁTIMA, CANTÓN Y PROVINCIA DE PASTAZA "

RUBRO	527	ANEXO: 1
DESCRIPCION	TENDIDO DE CONDUCTOR DE COBRE DE ALTA TENSION 1/0	
UNIDAD	m	
PERIODO	1 DE JUNIO 2021 A 30 DE JUNIO 2021	

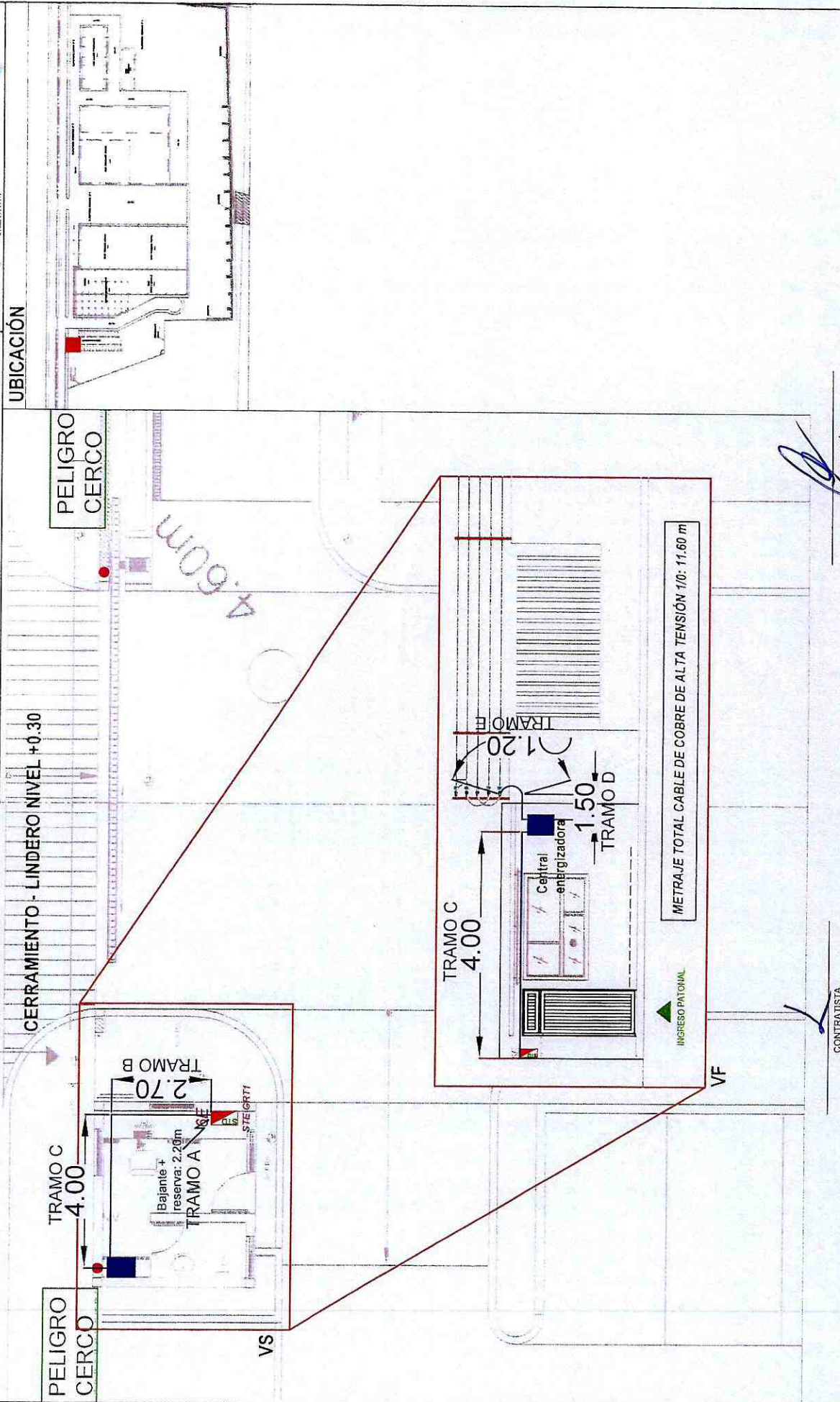

GOBIERNO AUTÓNOMO DESCENTRALIZADO DE LA PROVINCIA DEL PASTAZA

PROYECTO " CONSTRUCCIÓN DE LOS HANGARES DEL GOBIERNO AUTÓNOMO DESCENTRALIZADO PROVINCIAL DE PASTAZA (GADPPz) I ETAPA, PARROQUIA FÁTIMA, CANTÓN Y PROVINCIA DE PASTAZA "

PLANILLA DE AVANCE DE OBRA No. 23

RUBRO N° 528
DESCRIPCION: INSTALACION DE BATERIA Y SIRENA
UNIDAD: m
PERIODO: 01-jun 30-jun

ANEXO 1



PAG. 1 DE 1

Descripción	Cantidad	Dimensión	Total	GRAFICO #
INSTALACION DE BATERIA Y SIRENA	1,00		1,00	ANEXO 1
TOTAL:			1,00	

RESUMEN DE PLANILLA AL 100%					
DESCRIPCION	CONTRATADO	ANTERIOR	ACTUAL	ACUMULADO	UNIDAD
INSTALACION DE BATERIA Y SIRENA	0,00	-	1,00	1,00	m

[Signature]
CONTRATISTA

[Signature]
FISCALIZACIÓN

BIERNO AUTONOMO DESCENTRALIZADO DE LA
PROVINCIA DEL PASTAZA

PROYECTO:

* CONSTRUCCIÓN DE LOS HANGARES DEL GOBIERNO AUTÓNOMO DESCENTRALIZADO PROVINCIAL DE PASTAZA
(GADPPPZ) I ETAPA, PARROQUIA FÁTIMA, CANTÓN Y PROVINCIA DE PASTAZA *



RUBRO	528	ANEXO: 1
DESCRIPCION	INSTALACIONE BATERIA Y SIRENA	
UNIDAD	m	
PERIODO	1 DE JUNIO 2021 A 30 DE JUNIO 2021	

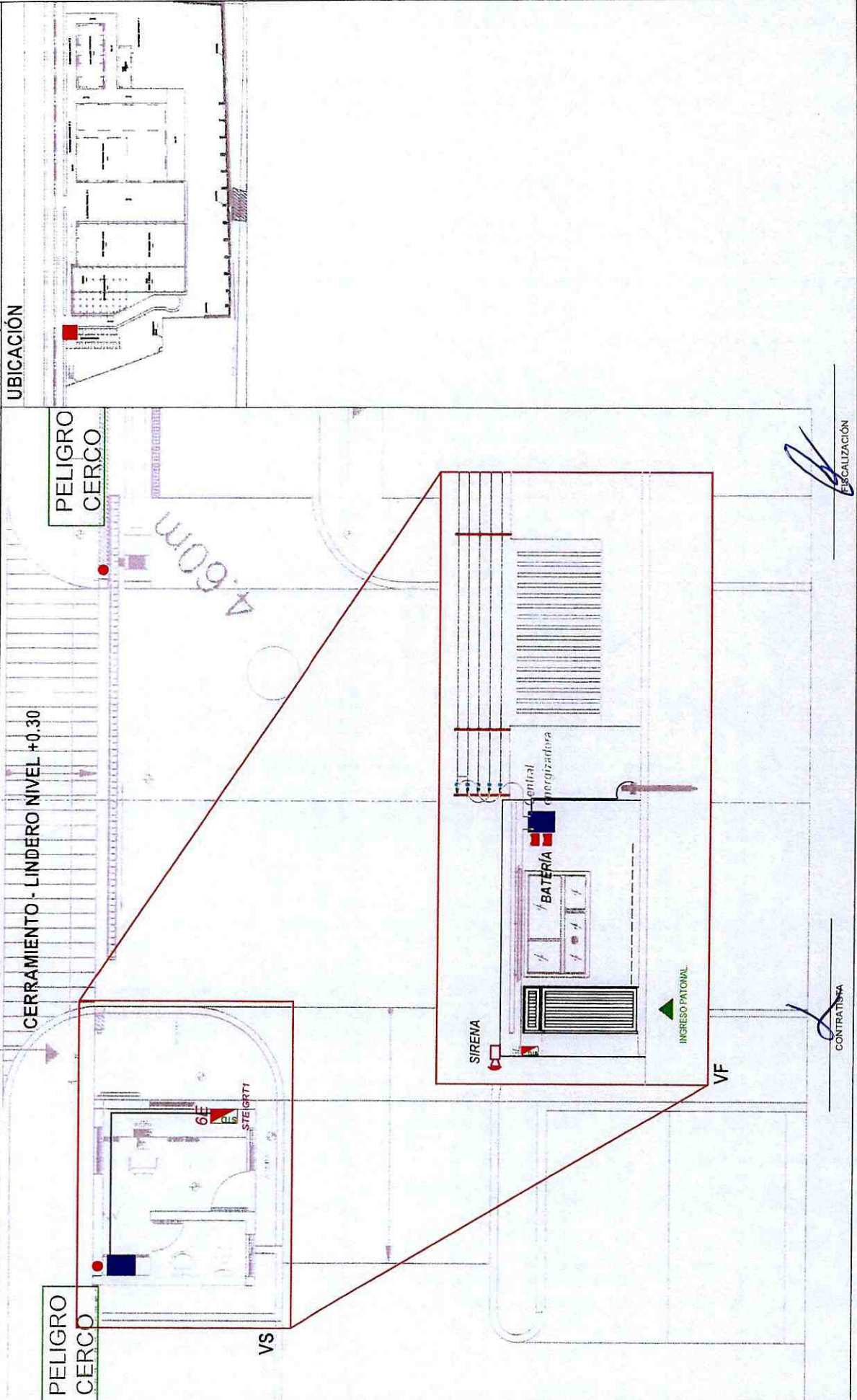

CONTRATISTA

ESCALACIÓN

PROYECTO " CONSTRUCCIÓN DE LOS HANGARES DEL GOBIERNO AUTÓNOMO DESCENTRALIZADO PROVINCIAL DE PASTAZA (GADPPz) I ETAPA, PARROQUIA FÁTIMA, CANTÓN Y PROVINCIA DE PASTAZA "

PLANILLA DE AVANCE DE OBRA No. 23

RUBRO N° 529 ANEXO 1
 DESCRIPCIÓN: SISTEMA DE PUESTA A TIERRA
 UNIDAD: u
 PERIODO: 01-jun 30-jun



PAG. 1 DE 1

Descripción	Cantidad	Dimensión	Total	GRAFICO #
SISTEMA DE PUESTA A TIERRA	1,00		1,00	ANEXO 1
TOTAL:			1,00	

RESUMEN DE PLANILLA AL 100%					
DESCRIPCIÓN	CONTRATADO	ANTERIOR	ACTUAL	ACUMULADO	UNIDAD
SISTEMA DE PUESTA A TIERRA	0,00	-	1,00	1,00	u

_____ 
 CONTRATISTA

_____ 
 FISCALIZACIÓN

**BIERNO AUTONOMO DESCENTRALIZADO DE LA
PROVINCIA DEL PASTAZA**

" CONSTRUCCIÓN DE LOS HANGARES DEL GOBIERNO AUTÓNOMO DESCENTRALIZADO PROVINCIAL DE PASTAZA
(GADPPz) I ETAPA, PARROQUIA FÁTIMA, CANTÓN Y PROVINCIA DE PASTAZA "

PROYECTO:	
RUBRO	529
DESCRIPCION	SISTEMA DE PUESTA A TIERRA
UNIDAD	U
PERIODO	1 DE JUNIO 2021 A 30 DE JUNIO 2021
ANEXO:	1



UBICACIÓN

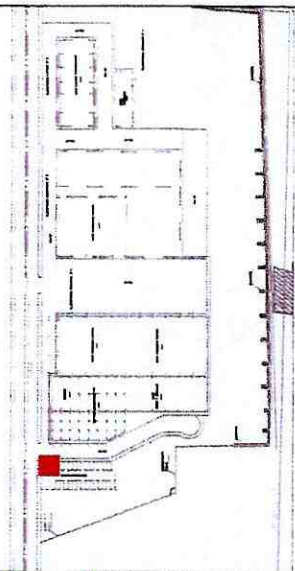

PELIGRO CERCO

CERRAMIENTO - LINDERO NIVEL +0.30

4.60m

PELIGRO CERCO

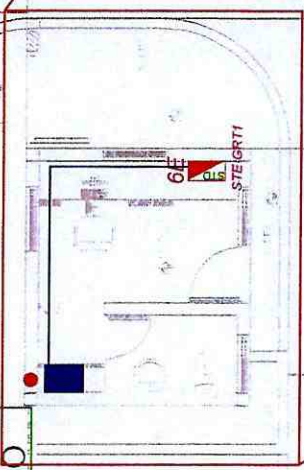

VS

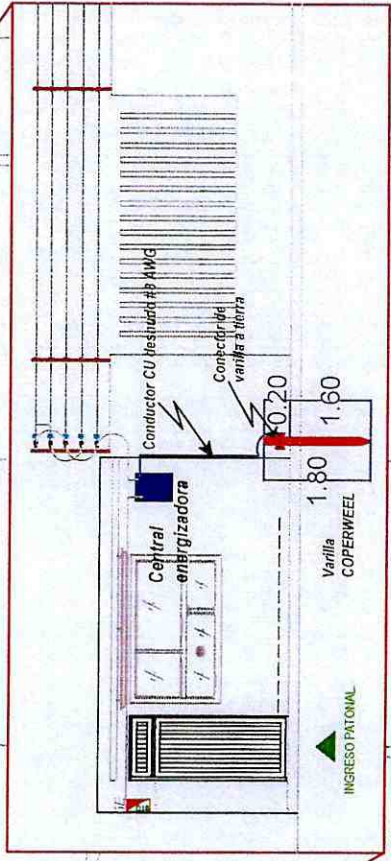

VF

ESCALIZACIÓN

CONTRATISTA

"CONSTRUCCIÓN DE LOS HANGARES DEL GOBIERNO AUTÓNOMO DESCENTRALIZADO PROVINCIAL DE PASTAZA (GADPPZ) (ETAPA, PARROQUIA FÁTIMA, CANTÓN Y PROVINCIA DE PASTAZA"

PROYECTO:

RUBRO	530
DESCRIPCION	TUBERIA PVC D=63 mm 1.0 mPA U/E + PRUEBA
UNIDAD	m
PERIODO	1 DE JUNIO 2021 A 30 DE JUNIO 2021

ANEXO: 1

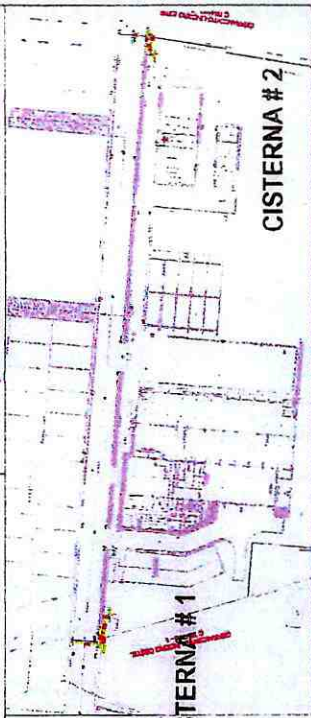

UBICACIÓN

CISTERNA # 1

PP-3/A

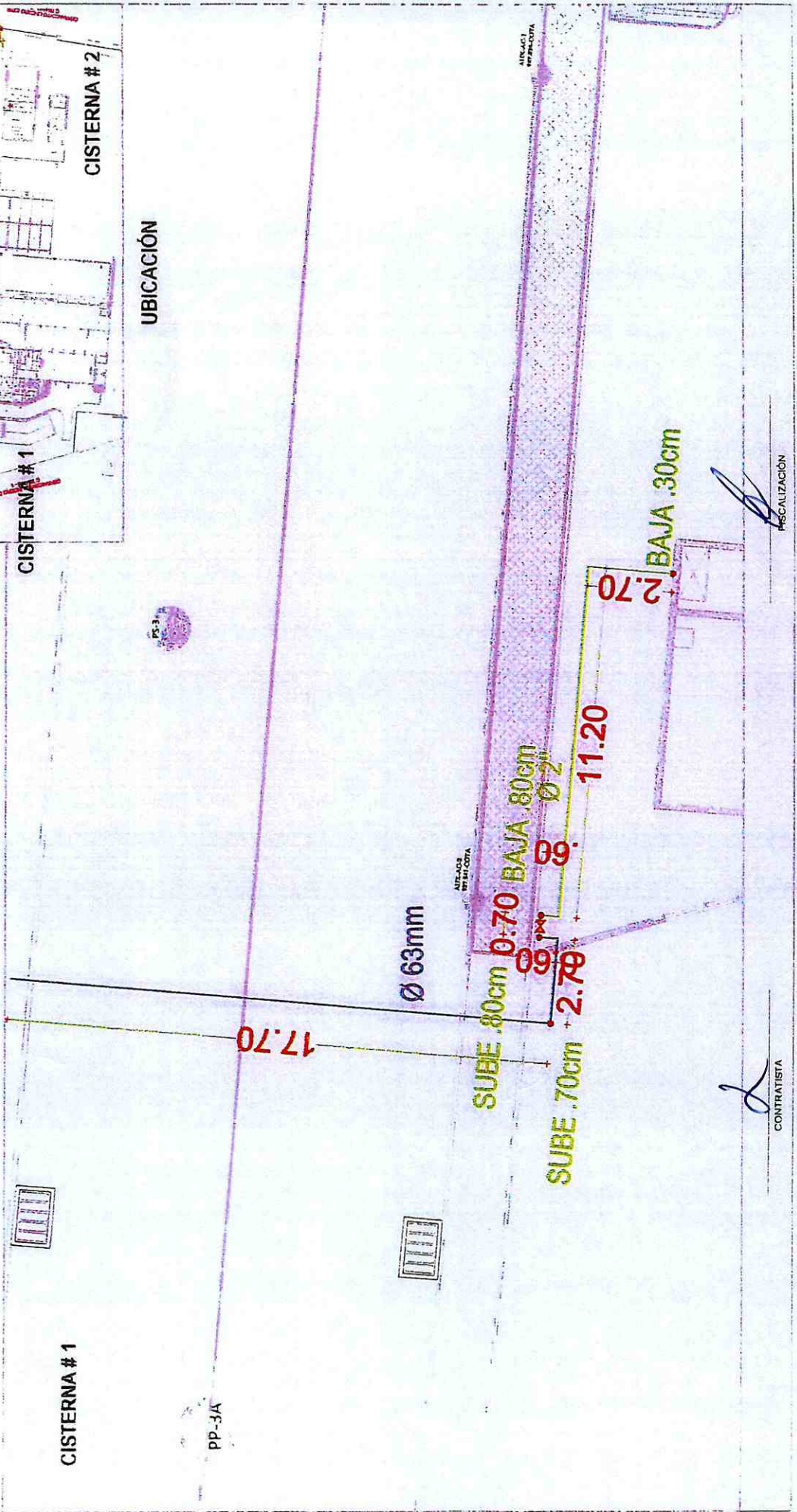

CONTRATISTA

MSCALIZACIÓN

GOBIERNO AUTONOMO DESCENTRALIZADO DE PASTAZA
PROVINCIA DEL PASTAZA

"CONSTRUCCIÓN DE LOS HANGARES DEL GOBIERNO AUTÓNOMO DESCENTRALIZADO PROVINCIAL DE PASTAZA (GADPPz) I ETAPA, PARROQUIA FÁTIMA, CANTÓN Y PROVINCIA DE PASTAZA"

PROYECTO:

RUBRO 530
 DESCRIPCIÓN TUBERÍA PVC D=63 mm 1.0 mPA u/E + PRUEBA
 UNIDAD m
 PERIODO 1 DE JUNIO 2021 A 30 DE JUNIO 2021

ANEXO: 2

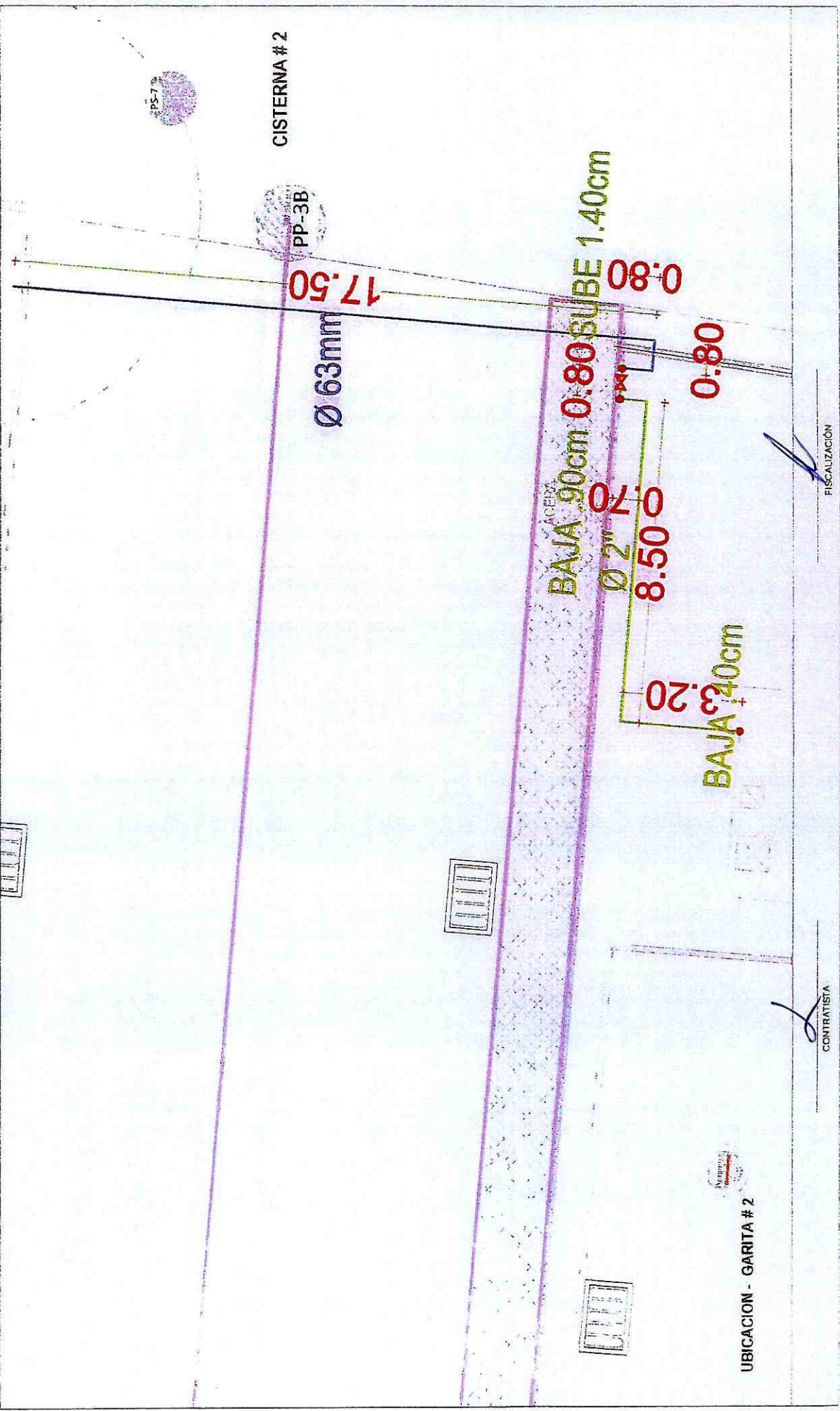

UBICACION - GARITA # 2

CONTRATISTA

FISCALIZACIÓN

GOBIERNO AUTÓNOMO DESCENTRALIZADO DE LA PROVINCIA DEL PASTAZA

PROYECTO * CONSTRUCCIÓN DE LOS HANGARES DEL GOBIERNO AUTÓNOMO DESCENTRALIZADO PROVINCIAL DE PASTAZA (GADPPz) I ETAPA, PARROQUIA FÁTIMA, CANTÓN Y PROVINCIA DE PASTAZA *
PLANILLA DE AVANCE DE OBRA No. 23

RUBRO N° 531 ANEXO 1
DESCRIPCIÓN: CONEXION DOMICILIARIA INC.mEDIDOR,EN TuBO D=63mm
UNIDAD: u
PERIODO: 01-jun 30-jun



1 DE 1

CONEXION DOMICILIARIA INC.mEDIDOR,EN TuBO D=63mm						
NAVE PRINCIPAL CISTERNA 1 Y LAVADO CISTERNA 2						
DESCRIPCION	LARGO (X)	ANCHO (Y)	ALTO (Z)	No.	SUBTOTAL	TOTAL
NAVE PRINCIPAL CISTERNA 1				1,00	1,00	1,00
LAVADO CISTERNA 2				1,00	1,00	1,00
					SUBTOTAL	2,00

RESUMEN DE PLANILLA AL 100%					
DESCRIPCION	CONTRATADO	ANTERIOR	ACTUAL	ACUMULADO	UNIDAD
CONEXION DOMICILIARIA INC.mEDIDOR,EN TuBO D=63mm	2,00	-	2,00	2,00	u

CONTRATISTA



FISCALIZACIÓN

**GOBIERNO AUTÓNOMO DESCENTRALIZADO DE LA
PROVINCIA DEL PASTAZA**

* CONSTRUCCIÓN DE LOS HANGARES DEL GOBIERNO AUTÓNOMO DESCENTRALIZADO PROVINCIAL DE PASTAZA
(GADPPZ) I ETAPA, PARROQUIA FATIMA, CANTÓN Y PROVINCIA DE PASTAZA *

PROYECTO:

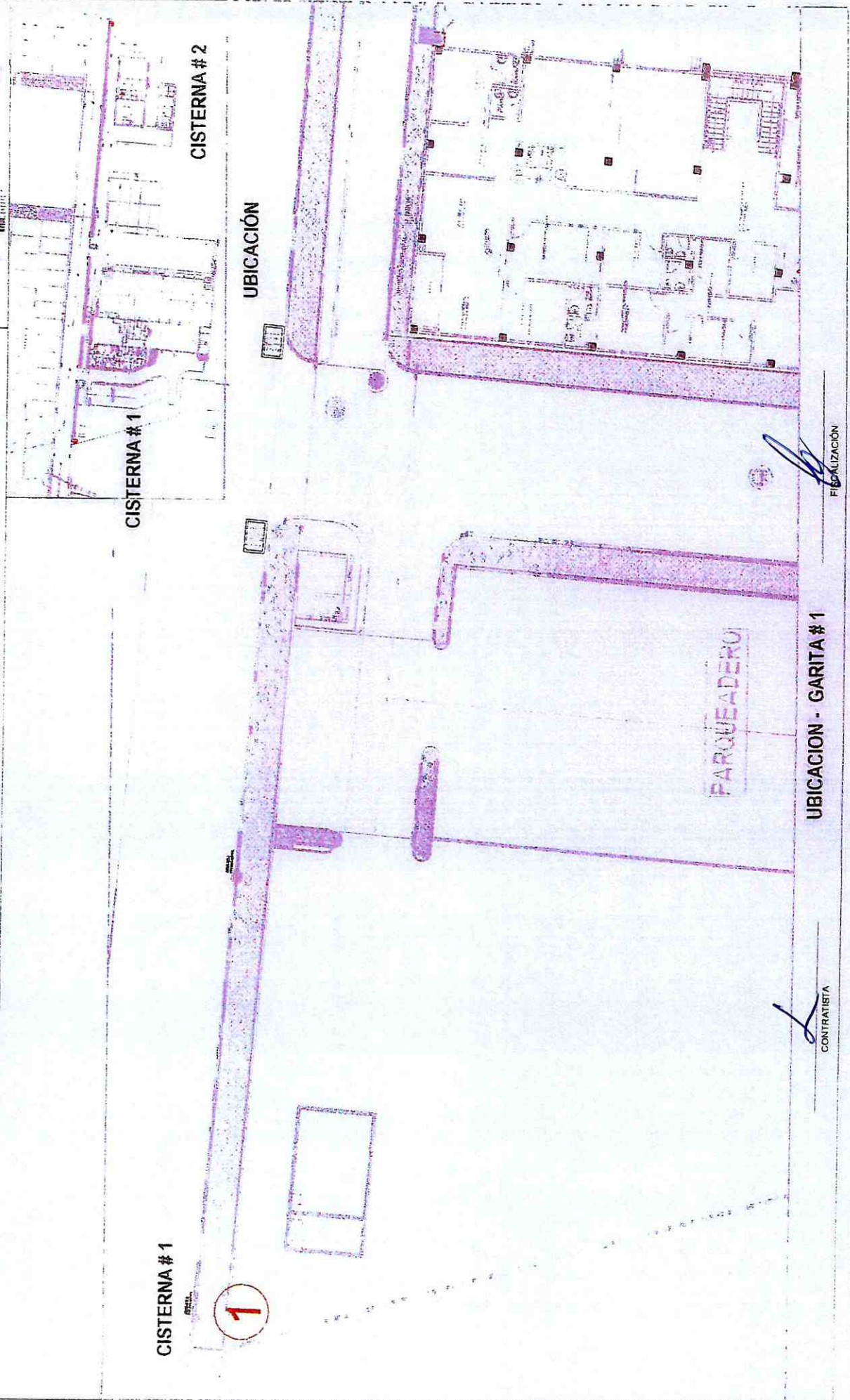
RUBRO	531	ANEXO: 1
DESCRIPCION	CONEXION DOMICILIARIA INC.MEDIDOR, EN TUBO D=63mm	
UNIDAD	U	
PERIODO	1 DE JUNIO 2021 A 30 DE JUNIO 2021	



CONTRATISTA

UBICACION - GARITA # 1

FIRMA Y FECHAS

GOBIERNO AUTÓNOMO DESCENTRALIZADO DE PASTAZA
PROVINCIA DEL PASTAZA

* CONSTRUCCIÓN DE LOS HANGARES DEL GOBIERNO AUTÓNOMO DESCENTRALIZADO PROVINCIAL DE PASTAZA
(GADPPz) I ETAPA, PARROQUIA FÁTIMA, CANTÓN Y PROVINCIA DE PASTAZA *

PROYECTO:

RUBRO: 531

DESCRIPCION: CONEXION DOMICILIARIA INC. mEDIDOR. EN TUBO D=63mm

UNIDAD: U

PERIODO: 1 DE JUNIO 2021 A 30 DE JUNIO 2021

ANEXO: 2

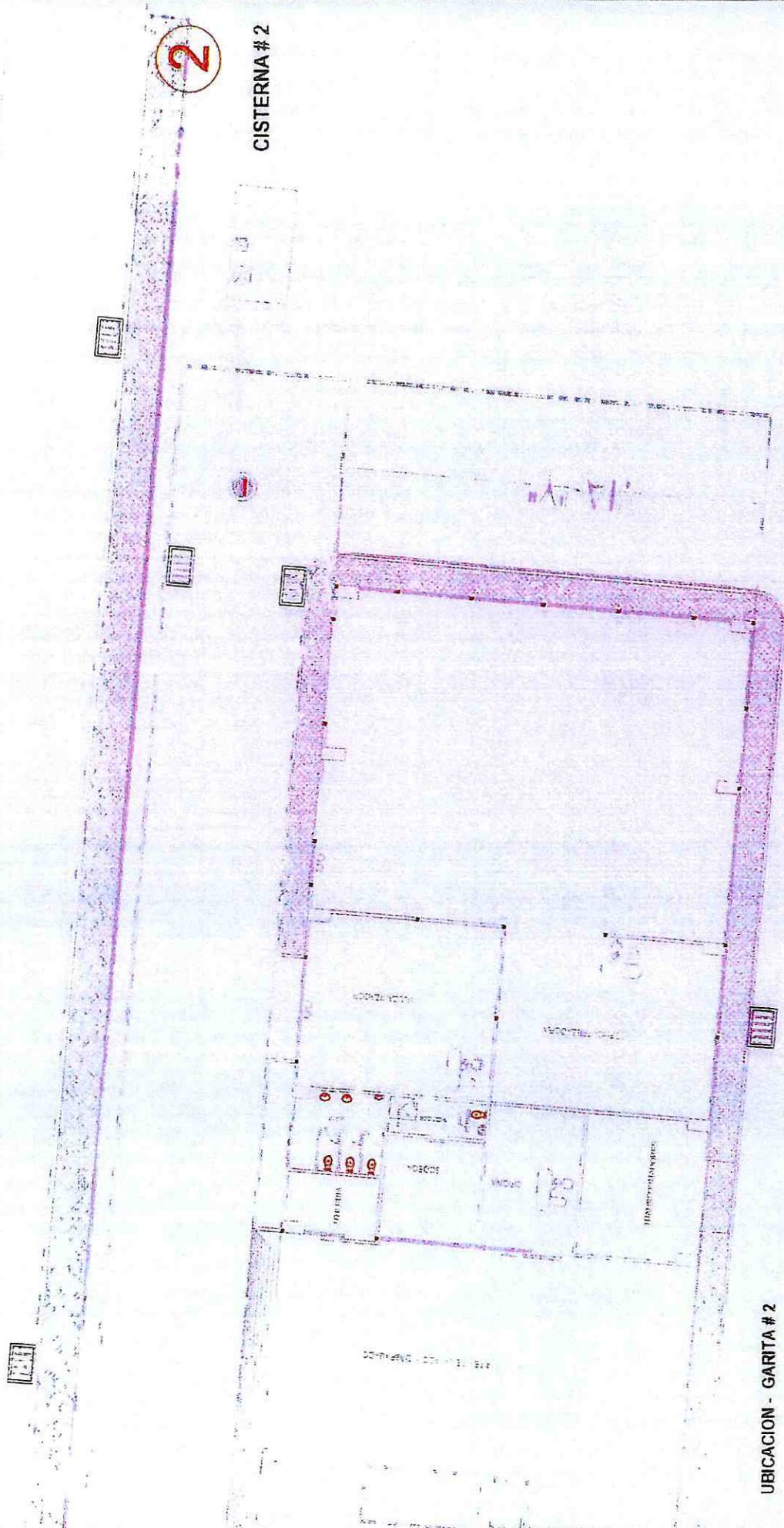

UBICACION - GARITA # 2

[Signature]
FISCALIZACIÓN

[Signature]
CONTRATISTA

PROYECTO * CONSTRUCCIÓN DE LOS HANGARES DEL GOBIERNO AUTÓNOMO DESCENTRALIZADO PROVINCIAL DE PASTAZA (GADPPz) I ETAPA, PARROQUIA FÁTIMA, CANTÓN Y PROVINCIA DE PASTAZA *
PLANILLA DE AVANCE DE OBRA No. 23

RUBRO N° 537
DESCRIPCIÓN: TUBERÍA PVC ROSCABLE D=2" EN EDIFICACION+PRUEBA ANEXO 1
UNIDAD: m
PERIODO: 01-jun 30-jun

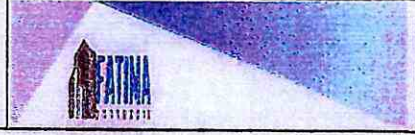

1 DE 1

TUBERÍA PVC ROSCABLE D=2" EN EDIFICACION+PRUEBA						
NAVE PRINCIPAL CISTERNA 1 Y LAVADO CISTERNA 2						
DESCRIPCION	LARGO (X)	ANCHO (Y)	ALTO (Z)	No.	SUBTOTAL	TOTAL
CISTERNA 1	0,70			1,00	0,70	0,70
	0,80			1,00	0,80	0,80
	0,60			1,00	0,60	0,60
	11,20			1,00	11,20	11,20
	2,70			1,00	2,70	2,70
CISTERNA 2	0,30			1,00	0,30	0,30
	0,80			1,00	0,80	0,80
	0,90			1,00	0,90	0,90
	0,70			1,00	0,70	0,70
	8,50			1,00	8,50	8,50
	3,20			1,00	3,20	3,20
	0,40			1,00	0,40	0,40
					SUBTOTAL	30,80

RESUMEN DE PLANILLA DE INCREMENTOS						
DESCRIPCION	CONTRATADO	ANTERIOR	ACTUAL	INCR. ANT.	INCR. ACT.	UNIDAD
TUBERIA PVC ROSCABLE D=2" EN EDIFICACION+PRUEBA	45,08	52,26			30,80	m



CONTRATISTA

FISCALIZACIÓN

"CONSTRUCCIÓN DE LOS HANGARES DEL GOBIERNO AUTÓNOMO DESCENTRALIZADO PROVINCIAL DE PASTAZA
 (GADPPz) I ETAPA, PARROQUIA FÁTIMA, CANTÓN Y PROVINCIA DE PASTAZA"

PROYECTO:

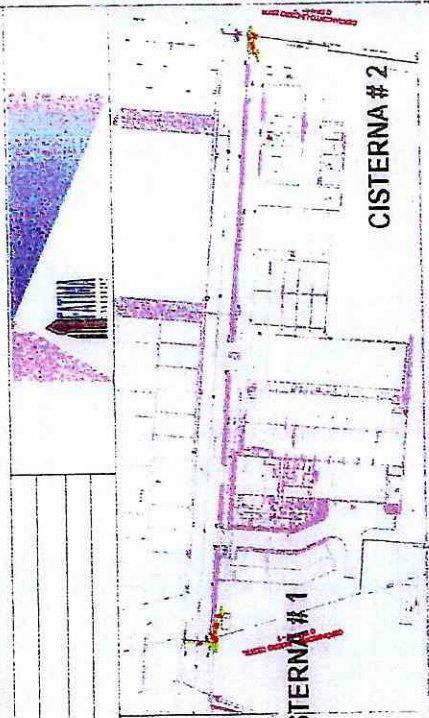
RUBRO	537	ANEXO: 1
DESCRIPCION	TUBERIA PVC ROSCABLE D=2" EN EDIFICACION+PRUEBA	
UNIDAD	m	
PERIODO	1 DE JUNIO 2021 A 30 DE JUNIO 2021	



UBICACIÓN

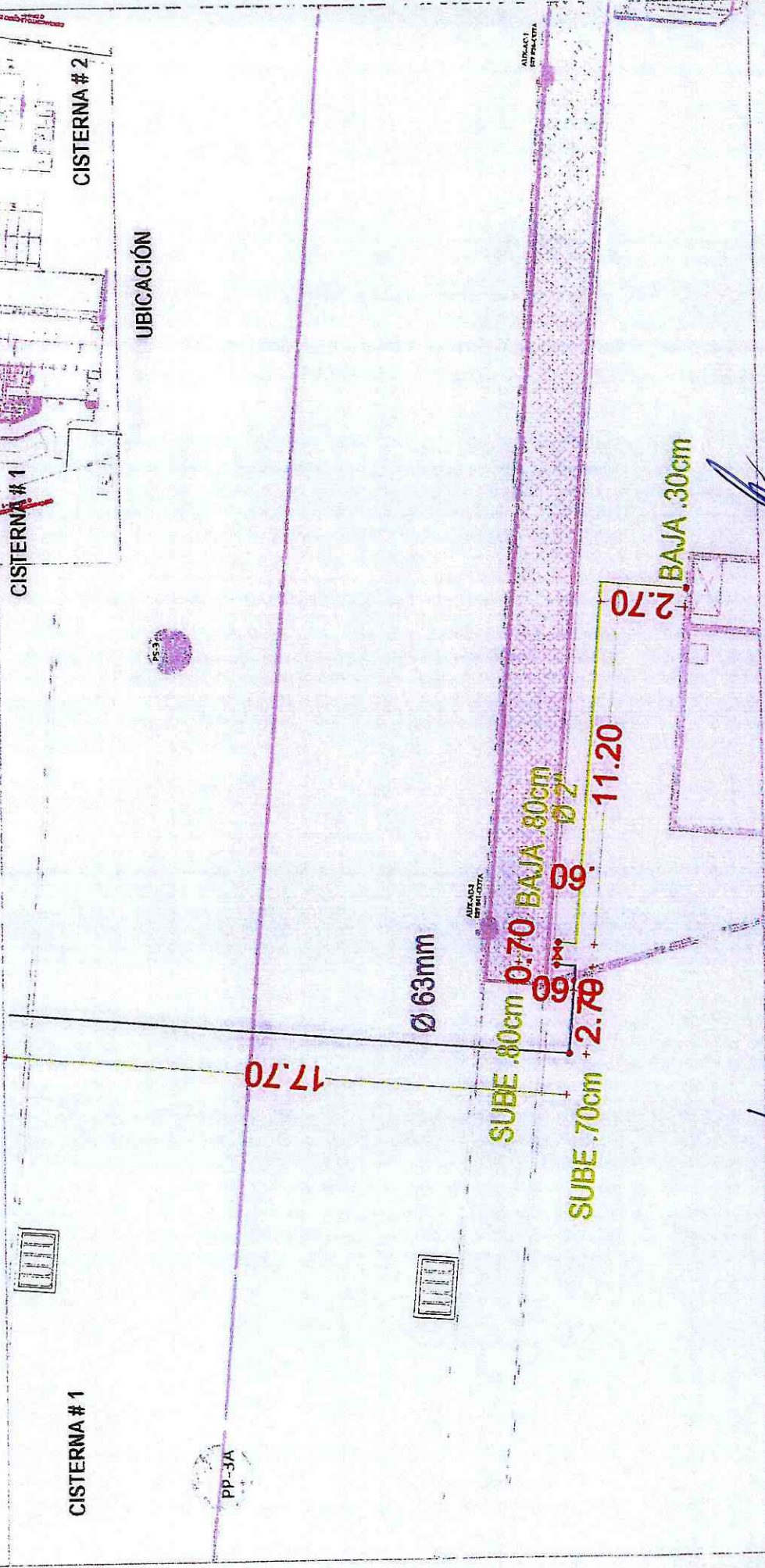

CISTERNA # 1

pp-3A

CONTRATISTA

FISCALIZACIÓN

" CONSTRUCCIÓN DE LOS HANGARES DEL GOBIERNO AUTÓNOMO DESCENTRALIZADO PROVINCIAL DE PASTAZA
(GADPPz) I ETAPA, PARROQUIA FÁTIMA, CANTÓN Y PROVINCIA DE PASTAZA "

PROYECTO:

RUBRO	537	ANEXO: 2
DESCRIPCION	TUBERIA PVC ROSCABLE D=2" EN EDIFICACION+PRUEBA	
UNIDAD	m	
PERIODO	1 DE JUNIO 2021 A 30 DE JUNIO 2021	

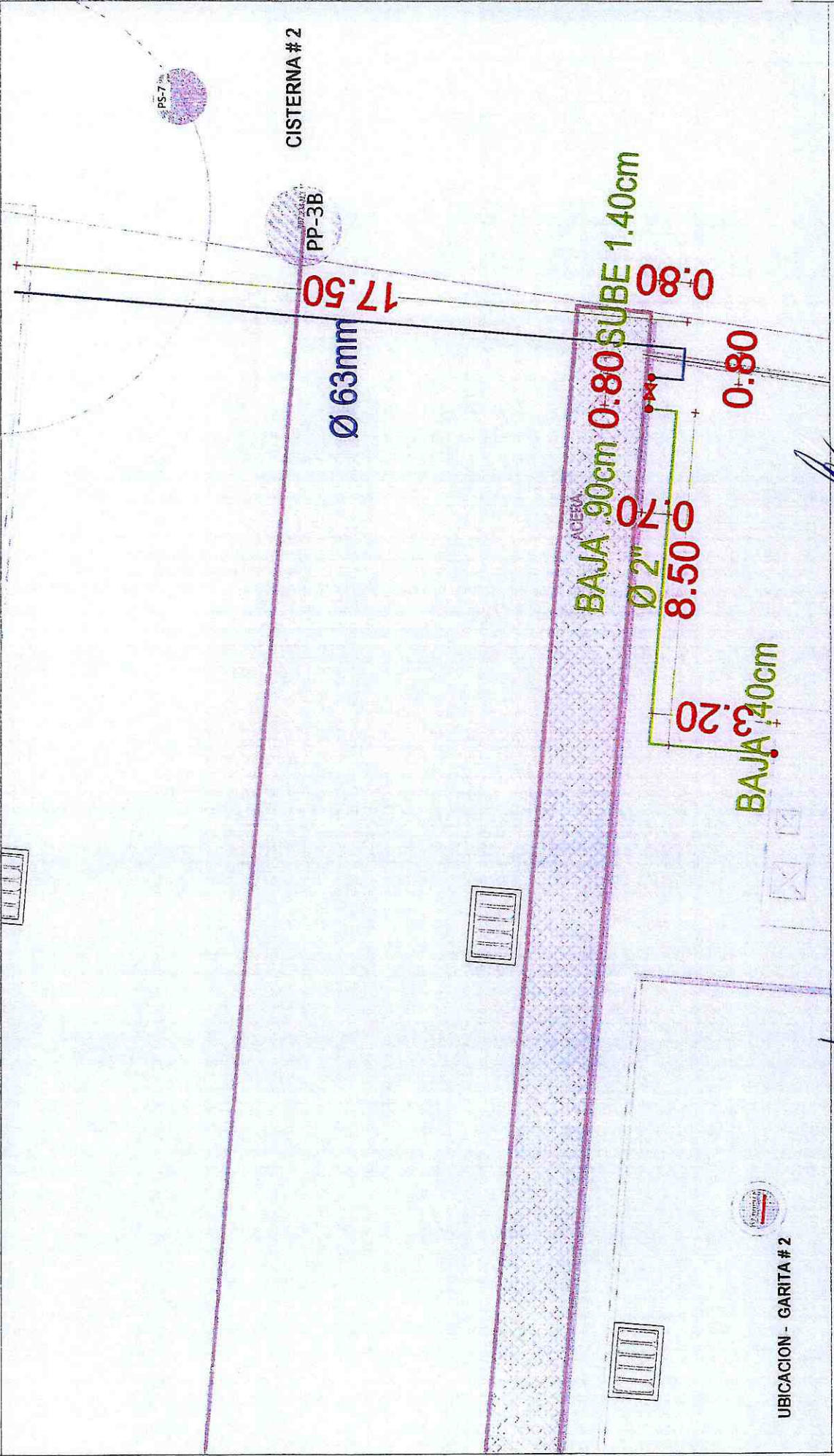

UBICACION - GARITA # 2

CONTRATISTA

FISCALIZACIÓN

PROYECTO " CONSTRUCCIÓN DE LOS HANGARES DEL GOBIERNO AUTÓNOMO DESCENTRALIZADO PROVINCIAL DE PASTAZA (GADPPz) I ETAPA, PARROQUIA FÁTIMA, CANTÓN Y PROVINCIA DE PASTAZA "

PLANILLA DE AVANCE DE OBRA No. 23

RUBRO N° 639 ANEXO 1
 DESCRIPCIÓN: ENLUCIDO CON IMPERMEABILIZANTE MORTERO 1:3 (EXTERIOR)
 UNIDAD: m2
 PERIODO: 01-jun 30-jun



PAG. 1 DE 1

ENLUCIDO CON IMPERMEABILIZANTE MORTERO 1:3 (EXTERIOR)						
TANQUES DE RESERVA DE AGUA-CISTERNAS 11 M3						
DESCRIPCION	LARGO (X)	ANCHO (Y)	ALTO (Z)	No.	SUBTOTAL	TOTAL
M1	2,00		1,75	2,00	3,50	7,00
M2	2,70		1,75	4,00	4,73	18,90
M3	2,55		1,75	2,00	4,46	8,93
M4	0,60		0,44	2,00	0,26	0,53
M5	2,70		0,44	2,00	2,38	4,75
P1	2,70	2,000		1,00	5,40	5,40
P2	2,70	2,600		1,00	7,02	7,02
					TOTAL	52,53

RESUMEN DE PLANILLA AL 100%					
DESCRIPCION	CONTRATADO	ANTERIOR	ACTUAL	ACUMULADO	UNIDAD
ENLUCIDO CON IMPERMEABILIZANTE MORTERO 1:3 (EXTERIOR)	69,83	-	52,53	52,53	m2



 CONTRATISTA



 FISCALIZACIÓN

BIENIO AUTONOMO DESCENTRALIZADO DE
 PROVINCIA DEL PASTAZA

* CONSTRUCCIÓN DE LOS HANGARES DEL GOBIERNO AUTÓNOMO DESCENTRALIZADO PROVINCIAL DE PASTAZA
 (GADPPPZ) I ETAPA, PARROQUIA FÁTIMA, CANTÓN Y PROVINCIA DE PASTAZA *

PROYECTO:	ANEXO: 1
RUBRO	639
DESCRIPCION	ENLUCIDO CON IMPERMEABILIZANTE MORTERO 1:3 (EXTERIOR)
UNIDAD	m ²
PERIODO	1 DE JUNIO 2021 A 30 DE JUNIO 2021



UBICACION - TANQUES DE RESERVA DE AGUA - CISTERNAS 11 M3

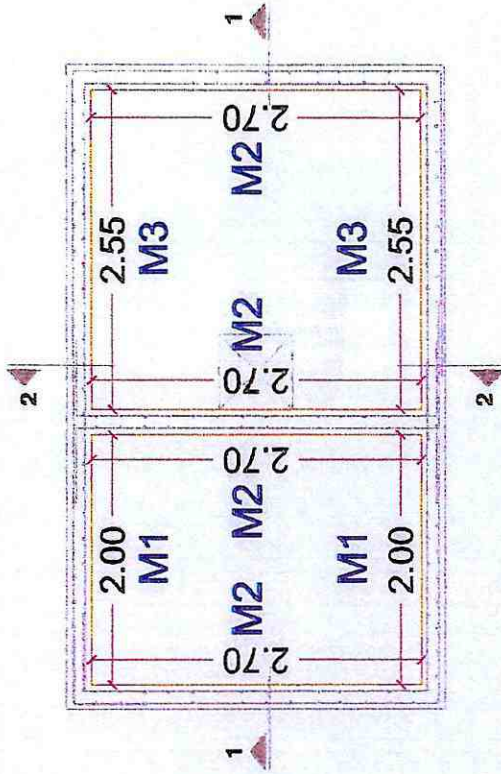
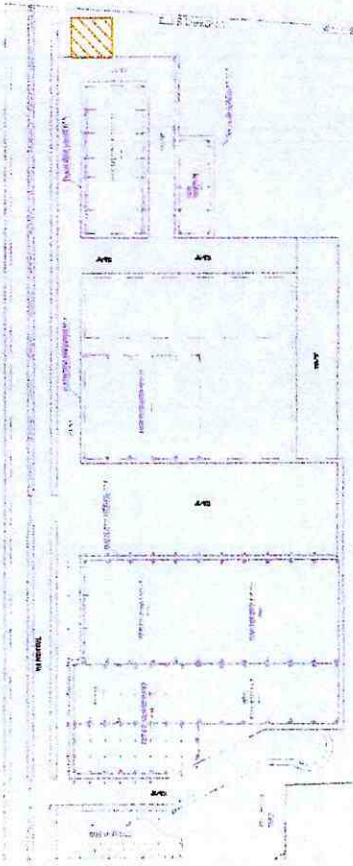

ENLUCIDO EXTERIOR MUROS - PLANTA CISTERNA

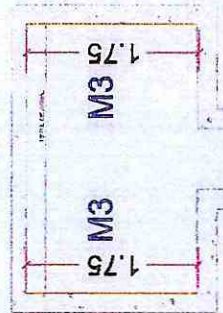
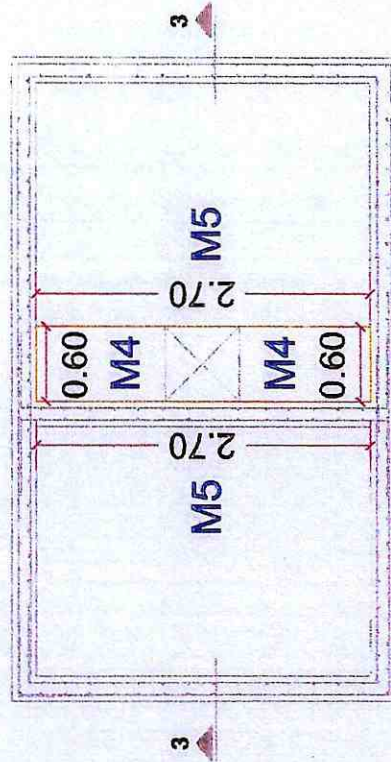

CORTE 2 - 2

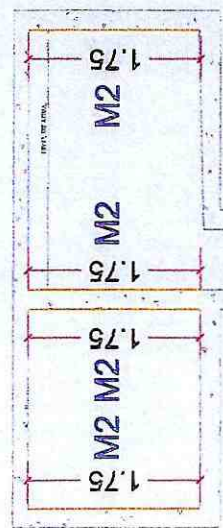

CORTE 1 - 1

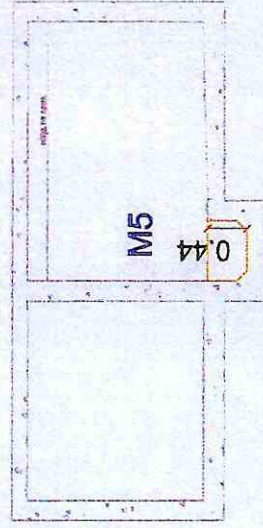

CORTE 3 - 3

[Signature]

FISCALIZACIÓN

[Signature]

CONTRATISTA

BIERNO AUTONOMO DESCENTRALIZADO DE PASTAZA
PROVINCIA DEL PASTAZA

" CONSTRUCCIÓN DE LOS HANGARES DEL GOBIERNO AUTÓNOMO DESCENTRALIZADO PROVINCIAL DE PASTAZA (GADPPz) I ETAPA, PARROQUIA FÁTIMA, CANTÓN Y PROVINCIA DE PASTAZA "

PROYECTO:			
RUBRO	639	ANEXO:	2
DESCRIPCION	ENLUCIDO CON IMPERMEABILIZANTE MORTERO 1:3 (EXTERIOR)		
UNIDAD	m ²		
PERIODO	1 DE JUNIO 2021 A 30 DE JUNIO 2021		



UBICACION - TANQUES DE RESERVA DE AGUA - CISTERNAS 11 M3

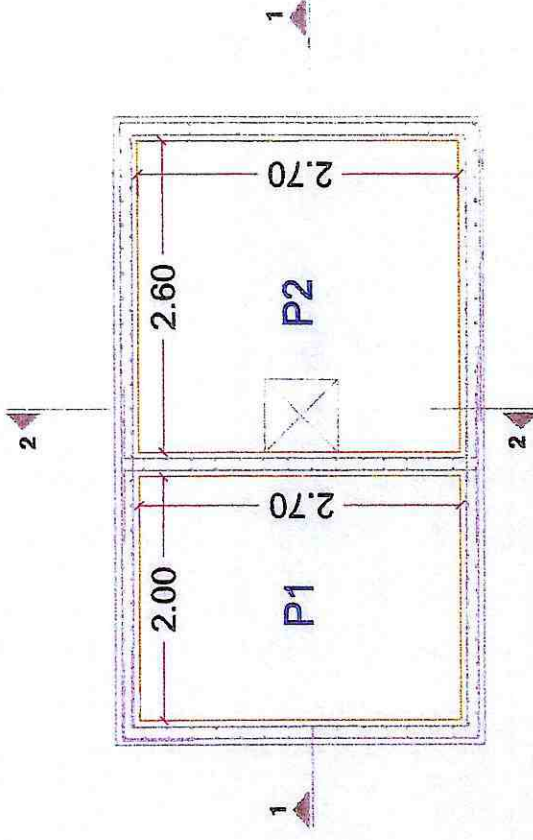
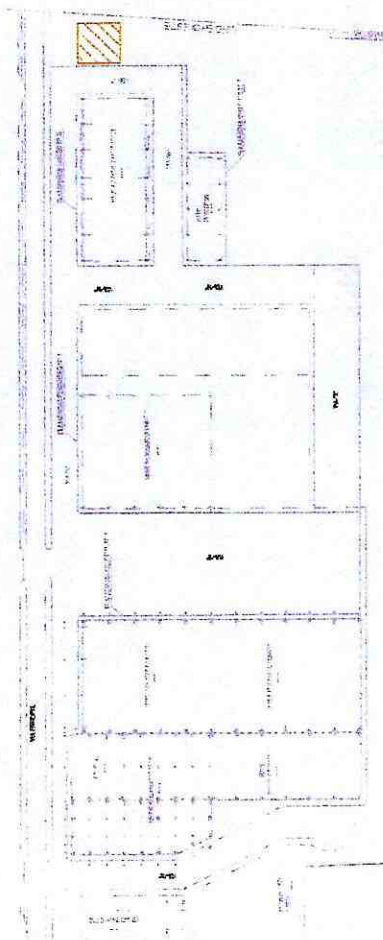

ENLUCIDO EXTERIOR LOSA SUPERIOR - PLANTA CISTERNA

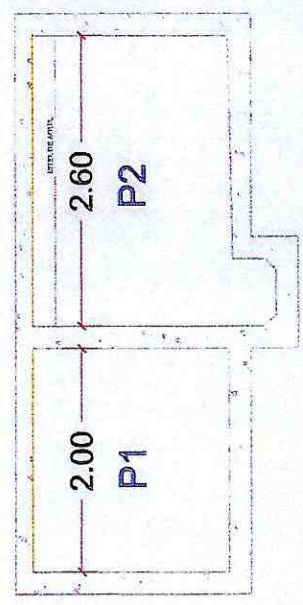

CORTE 1 - 1

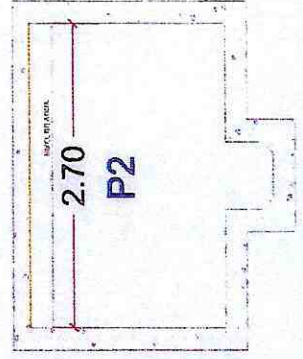

CORTE 2 - 2

 CONTRATISTA

 FISCALIZACIÓN

GOBIERNO AUTÓNOMO DESCENTRALIZADO DE LA PROVINCIA DEL PASTAZA

PROYECTO " CONSTRUCCIÓN DE LOS HANGARES DEL GOBIERNO AUTÓNOMO DESCENTRALIZADO PROVINCIAL DE PASTAZA (GADPPz) I ETAPA, PARROQUIA FÁTIMA, CANTÓN Y PROVINCIA DE PASTAZA "

PLANILLA DE AVANCE DE OBRA No. 23

RUBRO N° 640 ANEXO 1
 DESCRIPCIÓN: CERAmICA COLOR PISO Y PARED ANTIDESLIZANTE 0.30X0.30-INSTAL Y EmP
 UNIDAD: m2
 PERIODO: 01-jun 30-jun



PAG. 1 DE 1

CERAmICA COLOR PISO Y PARED ANTIDESLIZANTE 0.30X0.30-INSTAL Y EmP						
TANQUES DE RESERVA DE AGUA-CISTERNAS 11 M3						
DESCRIPCION	LARGO (X)	ANCHO (Y)	ALTO (Z)	No.	SUBTOTAL	TOTAL
M1	2,00		1,75	2,00	3,50	7,00
M2	2,70		1,75	4,00	4,73	18,90
M3	2,55		1,75	2,00	4,46	8,93
M4	0,60		0,44	2,00	0,26	0,53
M5	2,70		0,44	2,00	2,38	4,75
P1	2,70	2,000		1,00	5,40	5,40
P2	2,70	2,600		1,00	7,02	7,02
					TOTAL	52,53

RESUMEN DE PLANILLA AL 100%					
DESCRIPCION	CONTRATADO	ANTERIOR	ACTUAL	ACUMULADO	UNIDAD
CERAmICA COLOR PISO Y PARED ANTIDESLIZANTE 0.30X0.30-INSTAL Y EmP	69,83	-	52,53	52,53	m2



 CONTRATISTA



 FISCALIZACIÓN

" CONSTRUCCIÓN DE LOS HANGARES DEL GOBIERNO AUTÓNOMO DESCENTRALIZADO PROVINCIAL DE PASTAZA
 (GADPPz) I ETAPA, PARROQUIA FÁTIMA, CANTÓN Y PROVINCIA DE PASTAZA "

PROYECTO:	RUBRO	640	ANEXO: 1
	DESCRIPCIÓN	CERAMICA COLOR PISO Y PARED ANTIDESLIZANTE 0.30X0.30-INSTAL. Y Emp	
	UNIDAD	m ²	
	PERIODO	1 DE JUNIO 2021 A 30 DE JUNIO 2021	

UBICACION - TANQUES DE RESERVA DE AGUA - CISTERNAS 11 M3

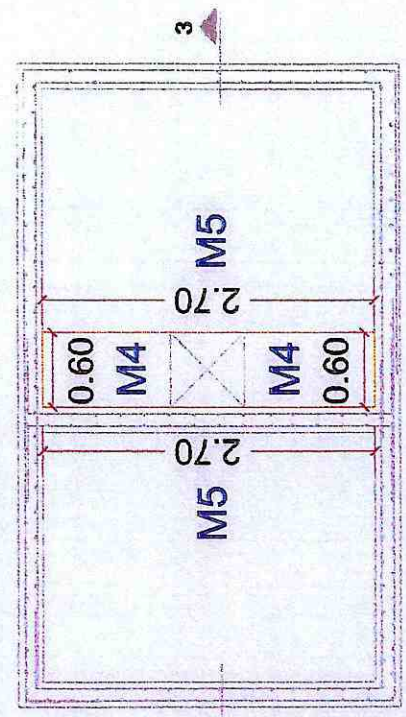
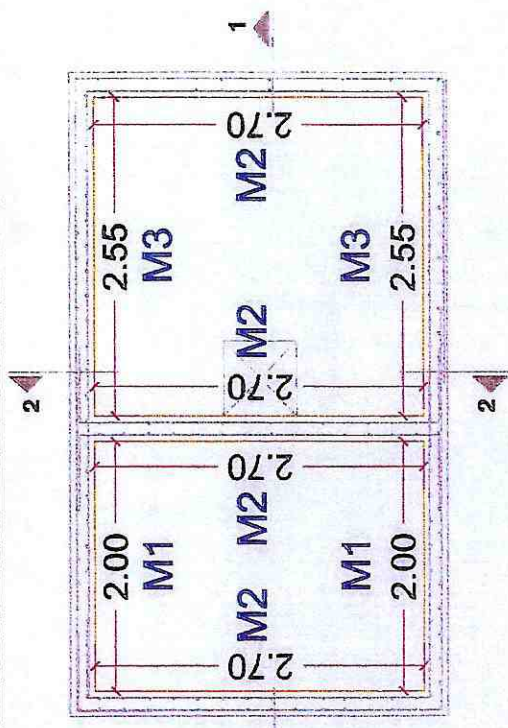
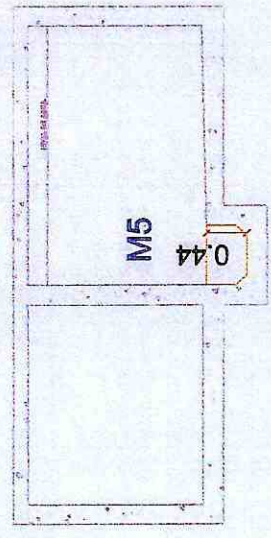
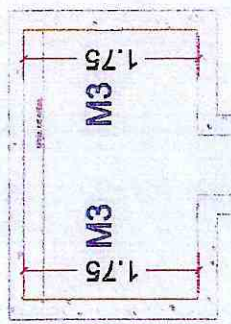
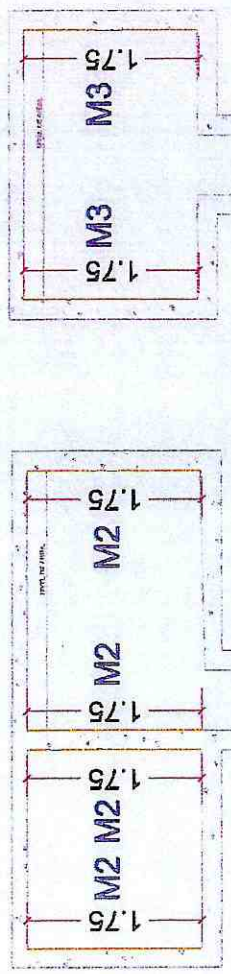
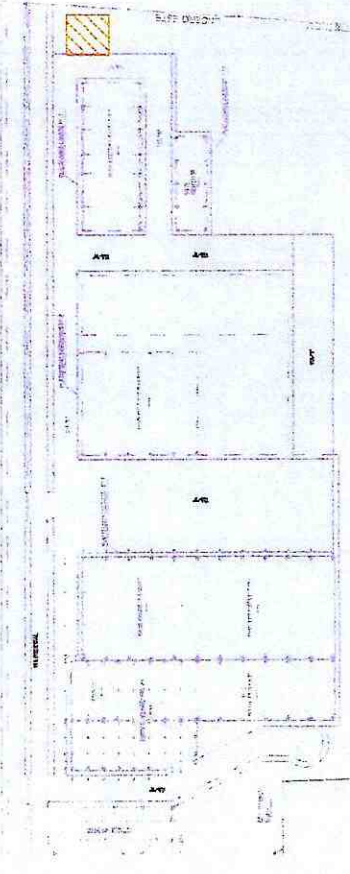

CONTRATISTA

FISCALIZACIÓN

" CONSTRUCCIÓN DE LOS HANGARES DEL GOBIERNO AUTÓNOMO DESCENTRALIZADO PROVINCIAL DE PASTAZA
 (GADPP2) I ETAPA, PARROQUIA FÁTIMA, CANTÓN Y PROVINCIA DE PASTAZA "

PROYECTO:	ANEXO: 2		
RUBRO	640		
DESCRIPCION	CERAMICA COLOR PISO Y PARED ANTIDESLIZANTE 0.30X0.30-INSTAL. Y EmP		
UNIDAD	m ²		
PERIODO	1 DE JUNIO 2021 A 30 DE JUNIO 2021		



UBICACION - TANQUES DE RESERVA DE AGUA - CISTERNAS 11 M3

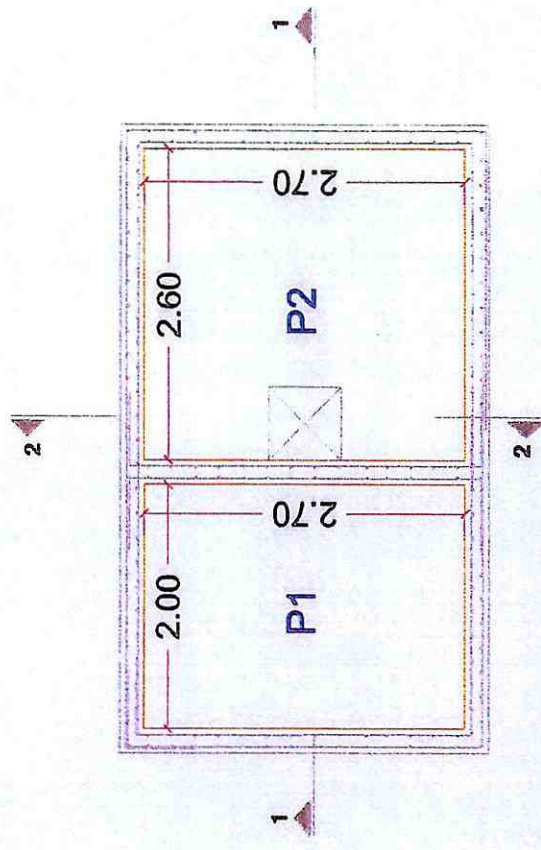
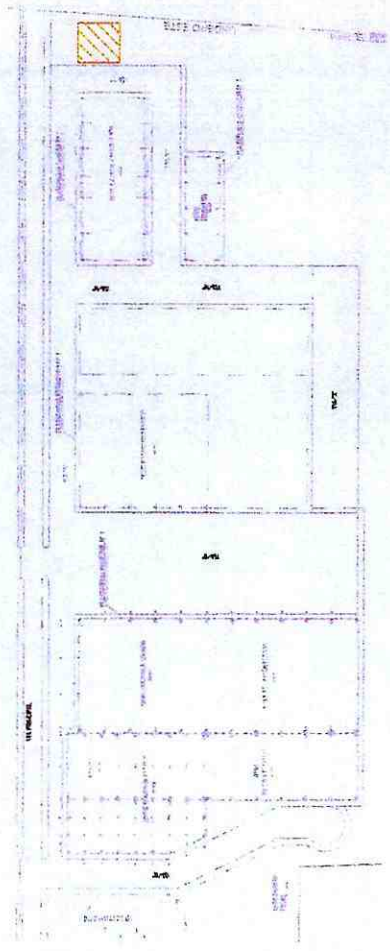

CERAMICA LOSA PISO- PLANTA CISTERNA

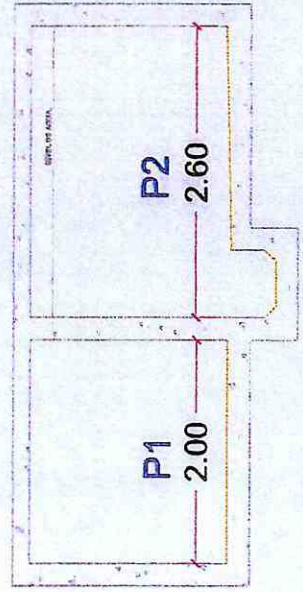

CORTE 1 - 1

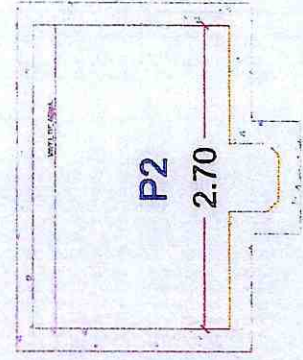

CORTE 2 - 2

[Signature]
 CONTRATISTA

[Signature]
 FISCALIZACIÓN

GOBIERNO AUTÓNOMO DESCENTRALIZADO DE LA PROVINCIA DEL PASTAZA

PROYECTO "CONSTRUCCIÓN DE LOS HANGARES DEL GOBIERNO AUTÓNOMO DESCENTRALIZADO PROVINCIAL DE PASTAZA (GADPPz) I ETAPA, PARROQUIA FÁTIMA, CANTÓN Y PROVINCIA DE PASTAZA "

PLANILLA DE AVANCE DE OBRA No. 23

RUBRO N° 635 ANEXO 1
 DESCRIPCIÓN: HORMIGÓN PREMEZCLADO Fc=210 KG/Cm2 INC. ENCOFRADO + BOMBEO Y TRANSPORTE
 UNIDAD: m3
 PERIODO: 01-jun 30-jun



HORMIGÓN PREMEZCLADO Fc=210 KG/Cm2 INC. ENCOFRADO + BOMBEO Y TRANSPORTE						
DESCRIPCIÓN	LARGO (X)	ANCHO (Y)	ALTO (Z)	No.	SUBTOTAL	TOTAL
BASE PARA MEDIA TENSION	37,14	1,00	0,10	1	3,71	3,710
					TOTAL	3,71

RESUMEN DE PLANILLA AL 100%						
DESCRIPCIÓN	CONTRATADO	ANTERIOR	ACTUAL	ACUMULADO	UNIDAD	
HORMIGÓN PREMEZCLADO Fc=210 KG/Cm2 INC. ENCOFRADO + BOMBEO Y TRANSPORTE	16,93	13,22	3,71	16,93	m3	



 CONTRATISTA



 FISCALIZACIÓN

GOB NO AUTONOMO DESCENTRALIZADO DE LA
 PROVINCIA DEL PASTAZA

" CONSTRUCCIÓN DE LOS HANGARES DEL GOBIERNO AUTÓNOMO DESCENTRALIZADO PROVINCIAL DE PASTAZA
 (GADPPZ) I ETAPA, PARROQUIA FÁTIMA, CANTÓN Y PROVINCIA DE PASTAZA "

PROYECTO:	635
RUBRO	HORMIGON PREMEZCLADO F'c=210 KG/Cm ² INC. ENCOFRADO + BOMBEO Y TRANSPORTE
DESCRIPCION	m ³
UNIDAD	
PERIODO	1 DE JUNIO 2021 A 30 DE JUNIO 2021

ANEXO: 1

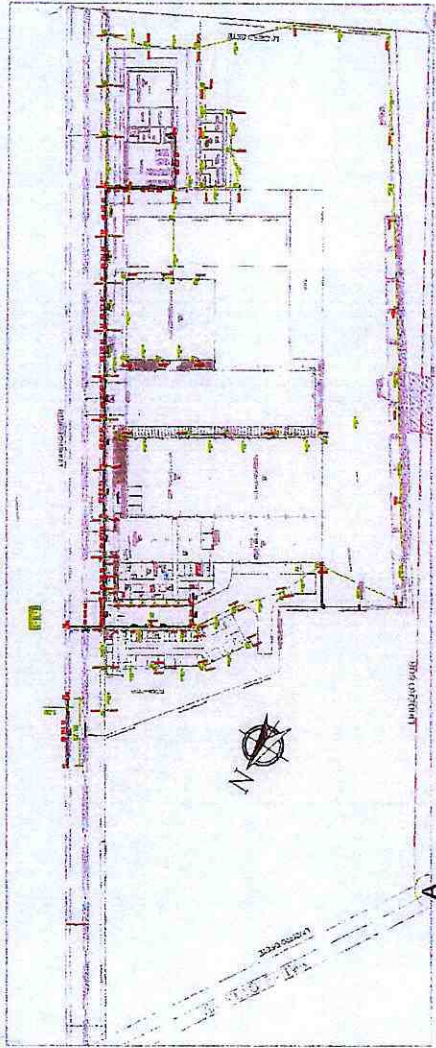
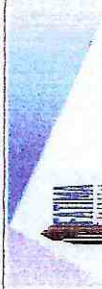

UBICACIÓN: VIA PRINCIPAL

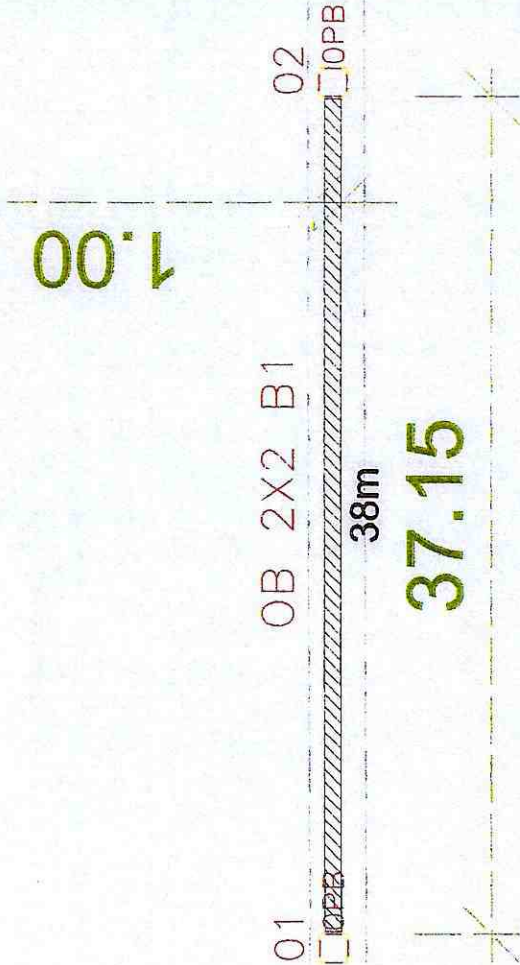

SECCIÓN

GOBIERNO AUTÓNOMO DESCENTRALIZADO DE LA PROVINCIA DEL PASTAZA

PROYECTO " CONSTRUCCIÓN DE LOS HANGARES DEL GOBIERNO AUTÓNOMO DESCENTRALIZADO PROVINCIAL DE PASTAZA (GADPPZ) I ETAPA, PARROQUIA FÁTIMA, CANTÓN Y PROVINCIA DE PASTAZA "

PLANILLA DE AVANCE DE OBRA No. 23

RUBRO N° 641 ANEXO 1
 DESCRIPCIÓN: PINTURA DE CAUCHO SATINADO COLOR (2 MANOS) INTER. <Guía ImAGEN CORPORATIVA GADPPZ>
 UNIDAD: m2
 PERIODO: 01-jun 30-jun



PAG. 1 DE 1

PINTURA DE CAUCHO SATINADO COLOR (2 MANOS) INTER. <Guía ImAGEN CORPORATIVA GADPPZ>						
TANQUES DE RESERVA DE AGUA-CISTERNAS 11 M3						
DESCRIPCION	LARGO (X)	ANCHO (Y)	ALTO (Z)	No.	SUBTOTAL	TOTAL
P1	2,70	2,000		1,00	5,40	5,40
P2	2,70	2,600		1,00	7,02	7,02
					TOTAL	12,42

RESUMEN DE PLANILLA AL 100%					
DESCRIPCION	CONTRATADO	ANTERIOR	ACTUAL	ACUMULADO	UNIDAD
PINTURA DE CAUCHO SATINADO COLOR (2 MANOS) INTER. <Guía ImAGEN CORPORATIVA GADPPZ>	15,00	-	12,42	12,42	m2



 CONTRATISTA



 FISCALIZACIÓN

BIENIO AUTÓNOMO DESCENTRALIZADO DE
PROVINCIA DEL PASTAZA

" CONSTRUCCIÓN DE LOS HANGARES DEL GOBIERNO AUTÓNOMO DESCENTRALIZADO PROVINCIAL DE PASTAZA
(GADPPz) I ETAPA, PARROQUIA FÁTIMA, CANTÓN Y PROVINCIA DE PASTAZA "

RUBRO 641
DESCRIPCION PINTURA DE CAUCHO SATINADO COLOR (2 MANOS) INTER. <Guía ImAGEN CORPORATIVA GADPPz>
UNIDAD m2
PERIODO 1 DE JUNIO 2021 A 30 DE JUNIO 2021

ANEXO: 1



UBICACION - TANQUES DE RESERVA DE AGUA - CISTERNAS 11 M3

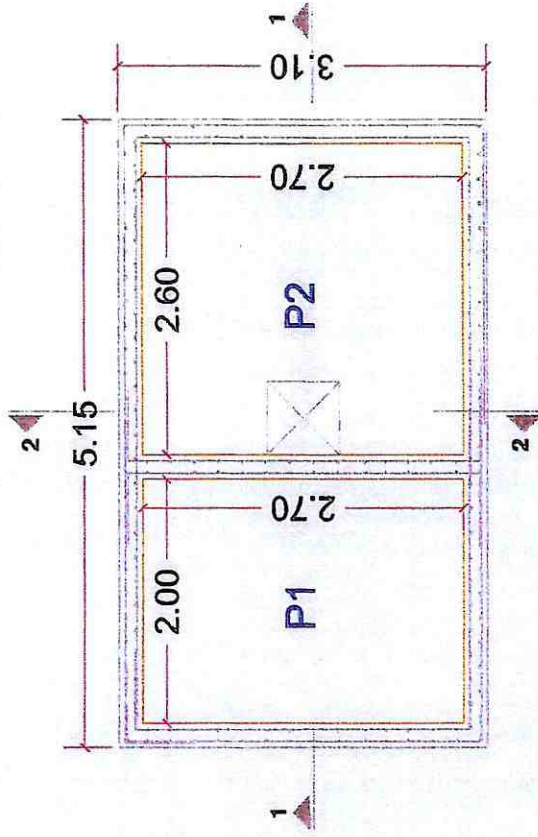
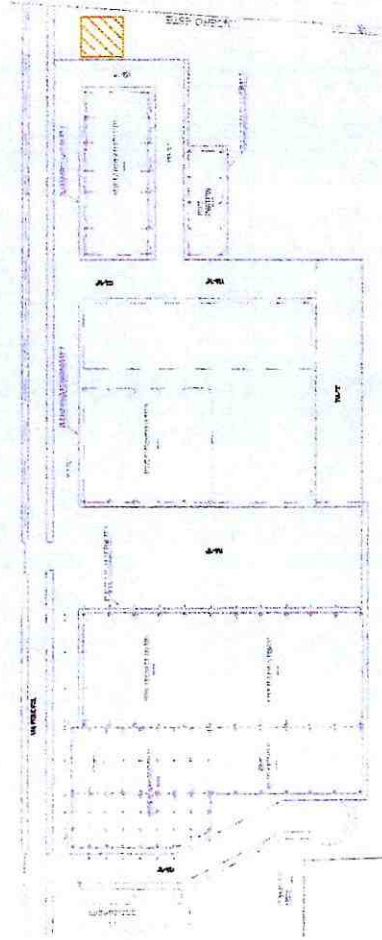

PINTURA LOSA SUPERIOR - PLANTA CISTERNA

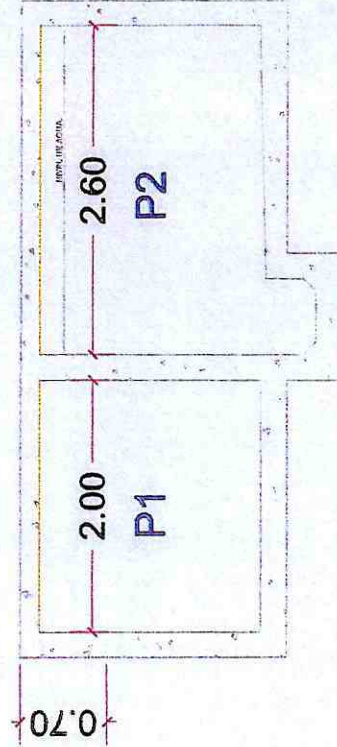

CORTE 1 - 1

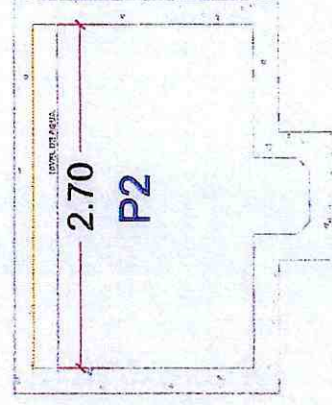

CORTE 2 - 2

[Signature]
CONTRATISTA

[Signature]
FISCALIZACIÓN

**BIERNO AUTONOMO DESCENTRALIZADO DE LA
PROVINCIA DEL PASTAZA**

" CONSTRUCCIÓN DE LOS HANGARES DEL GOBIERNO AUTÓNOMO DESCENTRALIZADO PROVINCIAL DE PASTAZA
(GADPPz) | ETAPA, PARROQUIA FÁTIMA, CANTÓN Y PROVINCIA DE PASTAZA "

PROYECTO:

RUBRO	715	ANEXO: 1
DESCRIPCION	BANDEJA TIPO ESCALERILLA 10CmX8Cm INCLUYE ACCESORIOS	
UNIDAD	m	
PERIODO	1 DE JUNIO 2021 A 30 DE JUNIO 2021	



ESTACIONAMIENTO (LINDERO OESTE - CISTERNA) NIVEL +0.03

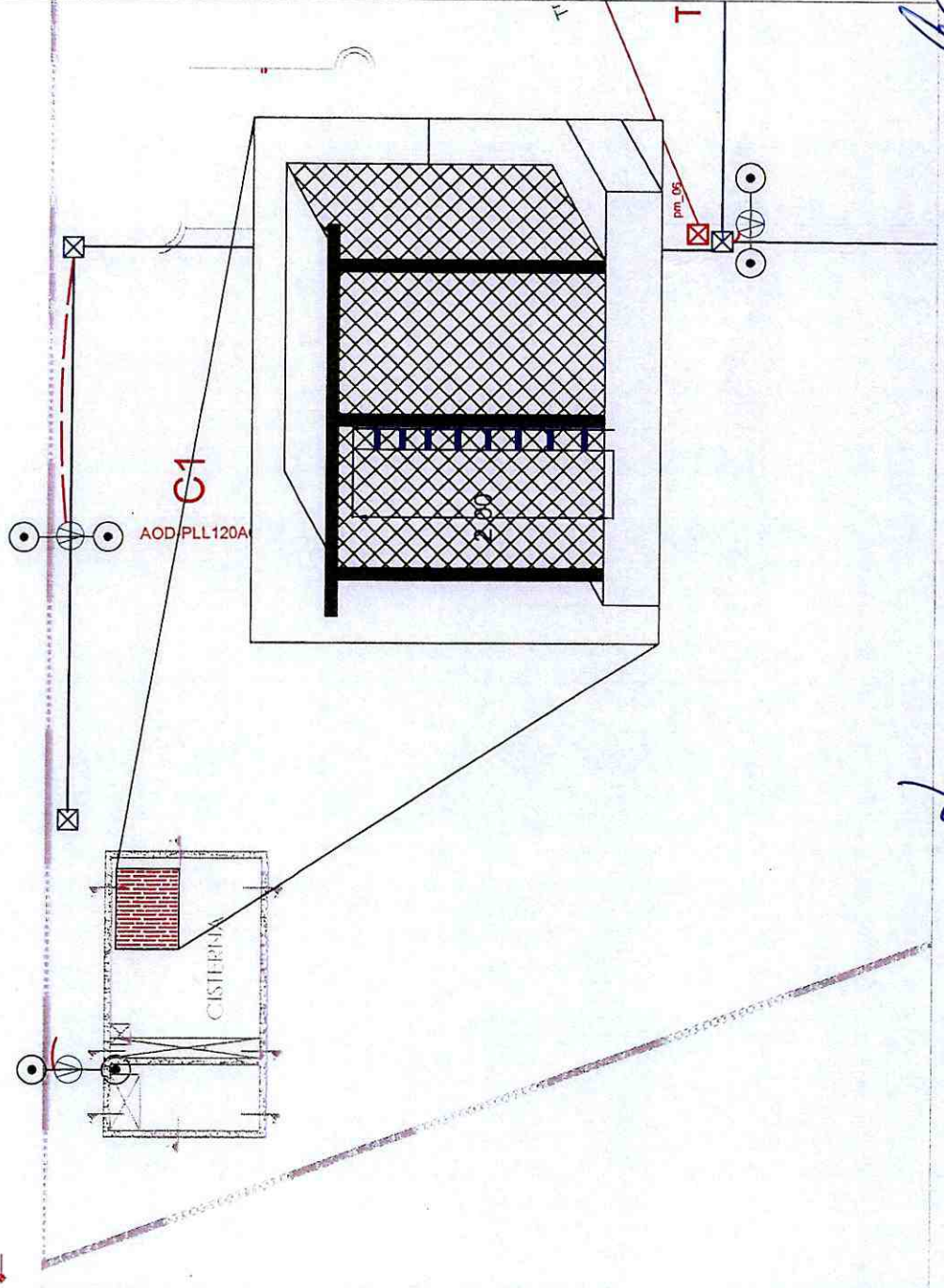

UBICACIÓN

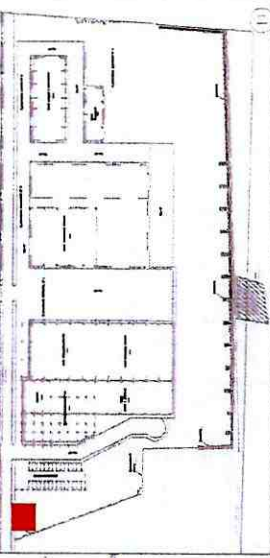

CONTRATISTA

FISCALIZACIÓN

**BIERNO AUTONOMO DESCENTRALIZADO DE LA
PROVINCIA DEL PASTAZA**

" CONSTRUCCIÓN DE LOS HANGARES DEL GOBIERNO AUTÓNOMO DESCENTRALIZADO PROVINCIAL DE PASTAZA
(GADPPz) | ETAPA, PARROQUIA FÁTIMA, CANTÓN Y PROVINCIA DE PASTAZA "



RUBRO	715	ANEXO: 1
DESCRIPCION	BANDEJA TIPO ESCALERILLA 10CmX8Cm INCLUYE ACCESORIOS	
UNIDAD	m	
PERIODO	1 DE JUNIO 2021 A 30 DE JUNIO 2021	

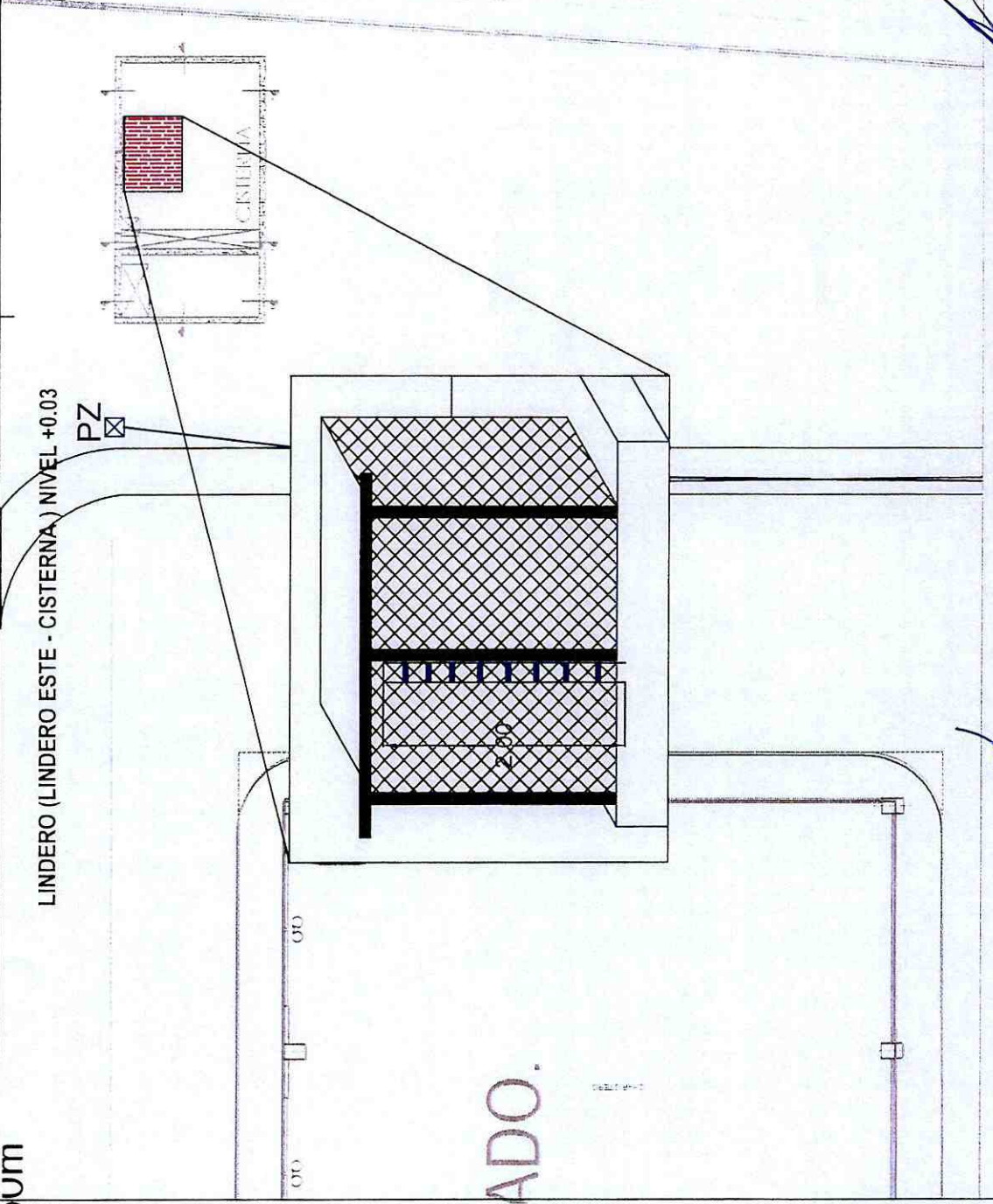
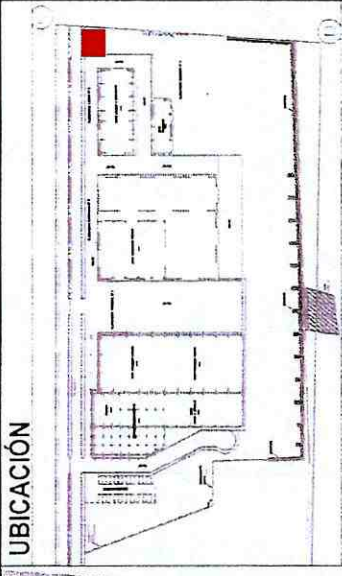

FISCALIZACIÓN

CONTRATISTA

ADO.

PROYECTO " CONSTRUCCIÓN DE LOS HANGARES DEL GOBIERNO AUTÓNOMO DESCENTRALIZADO PROVINCIAL DE PASTAZA (GADPPP) I ETAPA, PARROQUIA FÁTIMA, CANTON Y PROVINCIA DE PASTAZA "

PLANILLA DE AVANCE DE OBRA No. 23

RUBRO N°	750	ANEXO	1
DESCRIPCIÓN:	CABLE THHN No. 6 AWG 19H		
UNIDAD:	u		
PERIODO:	01-jun	30-jun	



PAG. 1 DE 1

Descripción	Cantidad	Dimensión	Total	GRAFICO #
CABLE THHN No. 6 AWG 19H (TRAMO A)	46,50		46,50	ANEXO 1
CABLE THHN No. 6 AWG 19H (TRAMO B)	15,00		15,00	
TOTAL:			61,50	

RESUMEN DE PLANILLA AL 100%					
DESCRIPCIÓN	CONTRATADO	ANTERIOR	ACTUAL	ACUMULADO	UNIDAD
CABLE THHN No. 6 AWG 19H	100,00	70,00	30,00	100,00	u

RESUMEN DE PLANILLA DE INCREMENTOS						
DESCRIPCIÓN	CONTRATADO	ANTERIOR	ACTUAL	INCR. ANT.	INCR. ACT.	UNIDAD
CABLE THHN No. 6 AWG 19H	100,00	70,00	0,00	0,00	31,50	u



 CONTRATISTA



 FISCALIZACIÓN

**BIERNO AUTONOMO DESCENTRALIZADO DE LA
PROVINCIA DEL PASTAZA**

" CONSTRUCCIÓN DE LOS HANGARES DEL GOBIERNO AUTÓNOMO DESCENTRALIZADO PROVINCIAL DE PASTAZA
(GADPPPz) I ETAPA, PARROQUIA FÁTIMA, CANTÓN Y PROVINCIA DE PASTAZA "

PROYECTO:			
RUBRO	750	ANEXO: 1	
DESCRIPCION	CABLE THHN No. 6 AWG 19H		
UNIDAD	m		
PERIODO	1 DE JUNIO 2021 A 30 DE JUNIO 2021		



UBICACIÓN

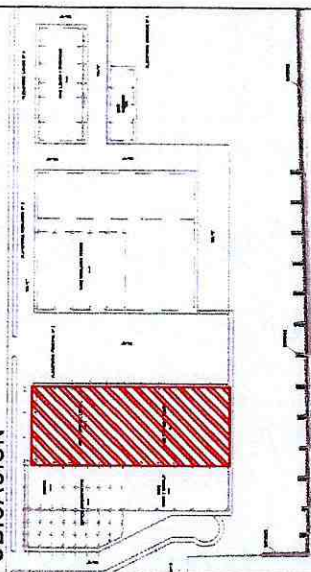

NAVE PRINCIPAL (MECÁNICA PESADA Y LIVIANA) NIVEL +0.03

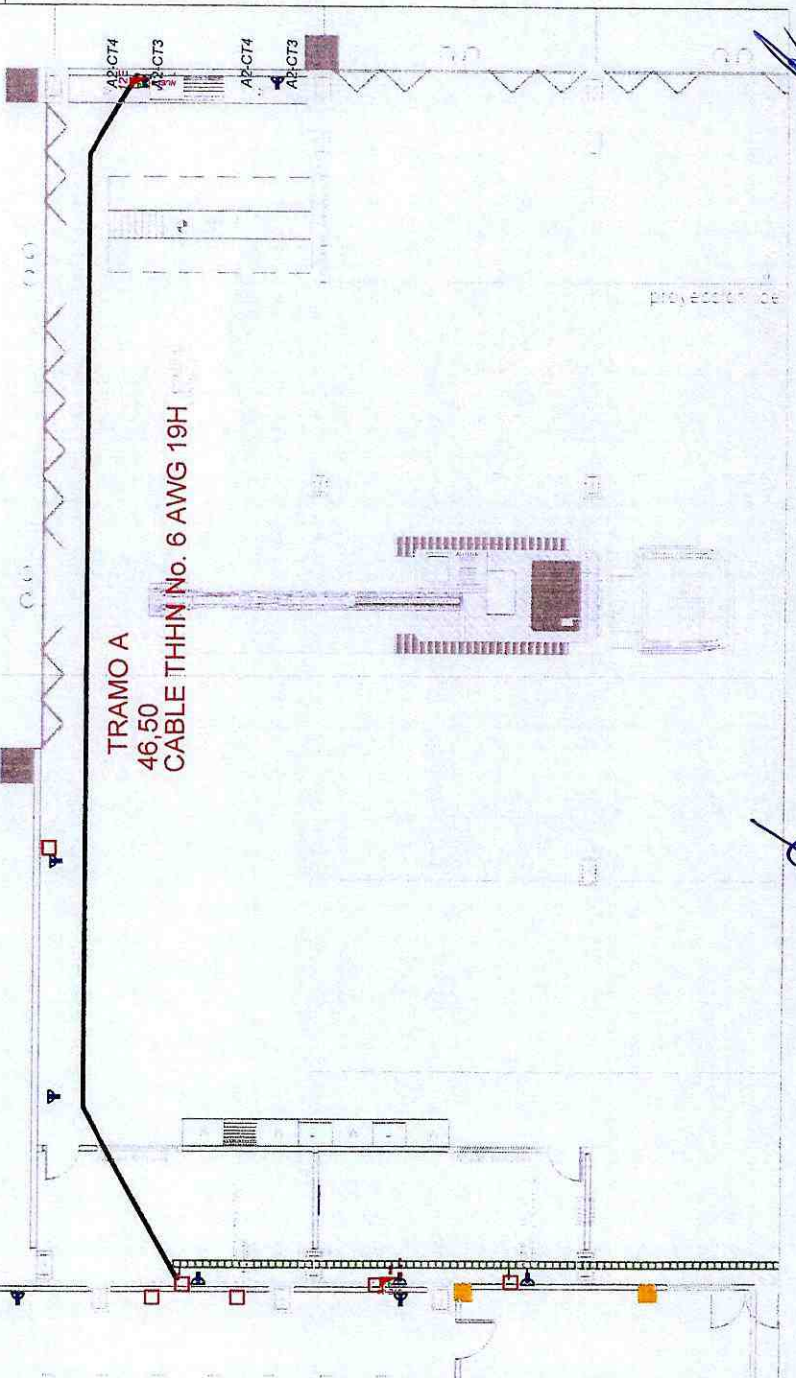

CONTRATISTA

FISCALIZACIÓN

**BIERNO AUTONOMO DESCENTRALIZADO DE LA
PROVINCIA DEL PASTAZA**

" CONSTRUCCIÓN DE LOS HANGARES DEL GOBIERNO AUTÓNOMO DESCENTRALIZADO PROVINCIAL DE PASTAZA
(GADPPz) I ETAPA, PARROQUIA FATIMA, CANTÓN Y PROVINCIA DE PASTAZA "

RUBRO	750
DESCRIPCION	CABLE THHN No. 6 AWG 19H
UNIDAD	m
PERIODO	1 DE JUNIO 2021 A 30 DE JUNIO 2021

ANEXO: 1

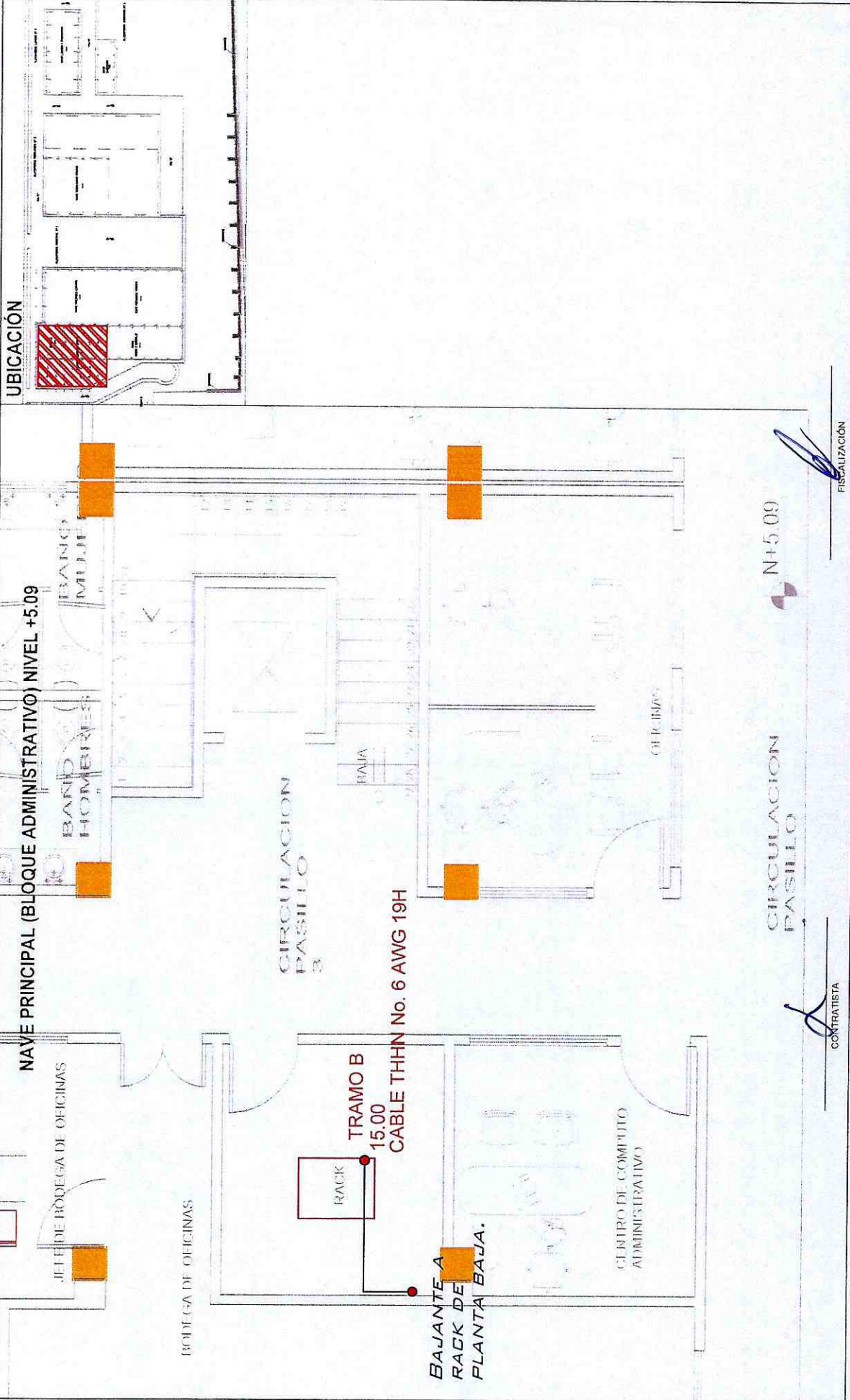

N+5.09

CIRCUACION PASILLO

CONTRATISTA

FISCALIZACION

GOBIERNO AUTONOMO DESCENTRALIZADO DE LA PROVINCIA DEL PASTAZA

* CONSTRUCCIÓN DE LOS HANGARES DEL GOBIERNO AUTÓNOMO DESCENTRALIZADO PROVINCIAL DE PASTAZA (GADPPZ) I ETAPA, PARROQUIA FÁTIMA, CANTÓN Y PROVINCIA DE PASTAZA *

PROYECTO:			
RUBRO	768	ANEXO: 1	
DESCRIPCION	DETECTOR DE Humo FOTOELECTRICO DIRECCIONABLE		
UNIDAD	u		
PERIODO	1 DE JUNIO 2021 A 30 DE JUNIO 2021		

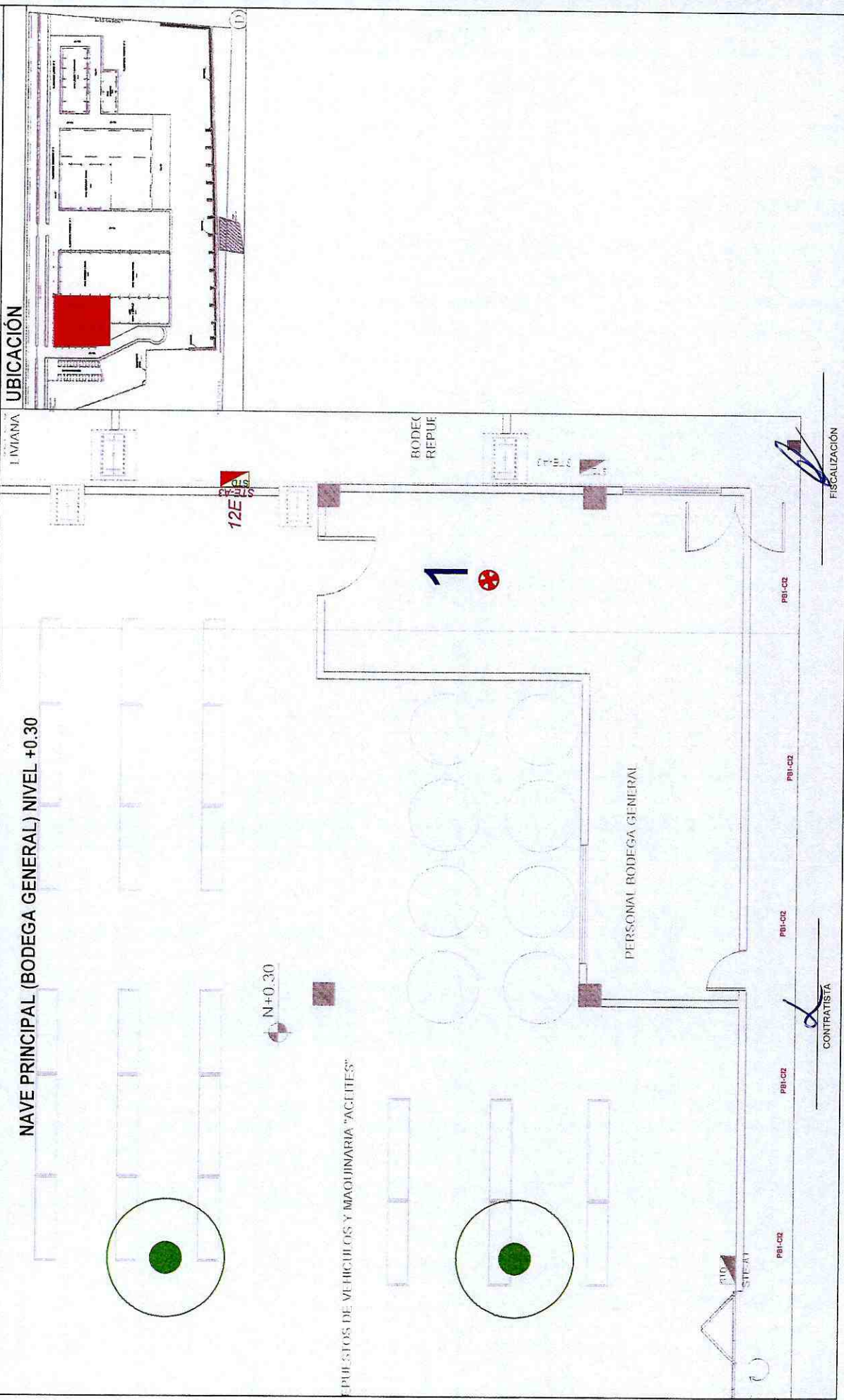

PROYECTO "CONSTRUCCIÓN DE LOS HANGARES DEL GOBIERNO AUTÓNOMO DESCENTRALIZADO PROVINCIAL DE PASTAZA (GADPP2) | ETAPA, PARROQUIA FÁTIMA, CANTÓN Y PROVINCIA DE PASTAZA "

PLANILLA DE AVANCE DE OBRA No. 23

RUBRO N° 770 ANEXO 1
 DESCRIPCIÓN: PUNTO DE ALARMAS DE INCENDIO
 UNIDAD: u
 PERIODO: 01-jun 30-jun



PAG. 1 DE 1

Descripción	Cantidad	Dimensión	Total	GRAFICO #
PUNTO DE ALARMAS DE INCENDIO	1,00		1,00	ANEXO 1
TOTAL:			1,00	

RESUMEN DE PLANILLA AL 100%					
DESCRIPCIÓN	CONTRATADO	ANTERIOR	ACTUAL	ACUMULADO	UNIDAD
PUNTO DE ALARMAS DE INCENDIO	153.00	153.00	0.00	153.00	u

RESUMEN DE PLANILLA DE INCREMENTOS						
DESCRIPCIÓN	CONTRATADO	ANTERIOR	ACTUAL	INCR. ANT.	INCR. ACT.	UNIDAD
PUNTO DE ALARMAS DE INCENDIO	153.00	153.00	0.00	0.00	1.00	u



 CONTRATISTA

 FISCALIZACIÓN

GOBIERNO AUTÓNOMO DESCENTRALIZADO DE LA PROVINCIA DEL PASTAZA

" CONSTRUCCIÓN DE LOS HANGARES DEL GOBIERNO AUTÓNOMO DESCENTRALIZADO PROVINCIAL DE PASTAZA (GADPPz) | ETAPA, PARROQUIA FATIMA, CANTÓN Y PROVINCIA DE PASTAZA "

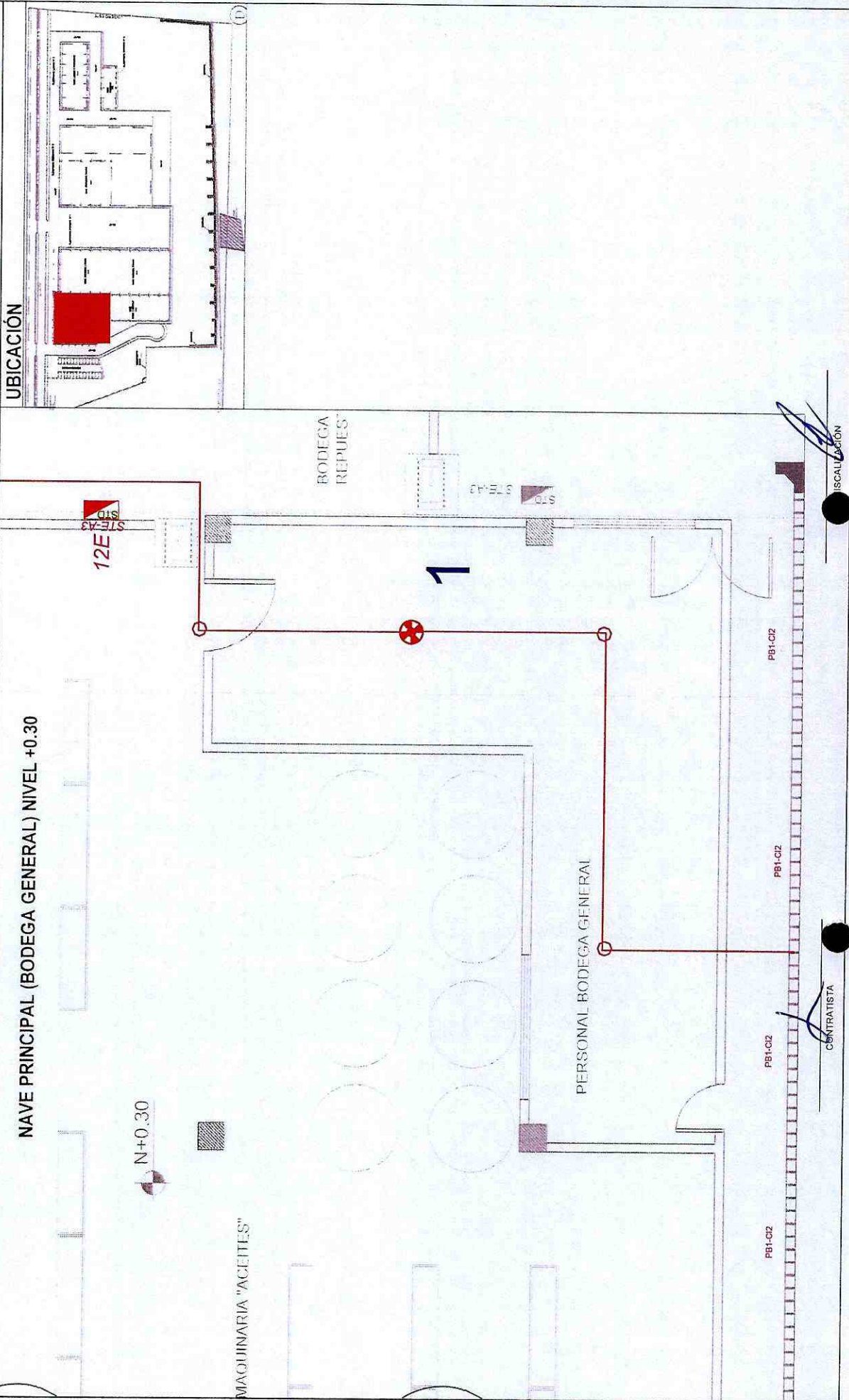
PROYECTO:	770	ANEXO: 1
RUBRO	PUNTO DE ALARMAS DE INCENDIO	
DESCRIPCION	U	
UNIDAD	1 DE JUNIO 2021 A 30 DE JUNIO 2021	
PERIODO		



UBICACIÓN

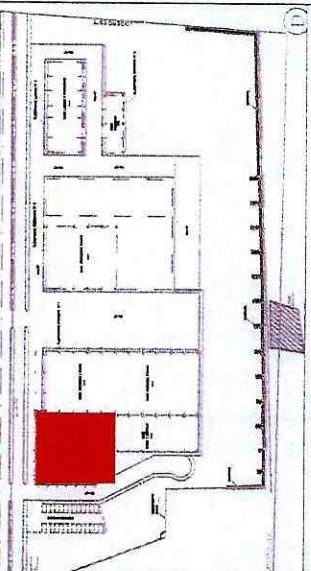

CONTRATISTA

VERIFICACION

**BIERNO AUTONOMO DESCENTRALIZADO DE LA
PROVINCIA DEL PASTAZA**

PROYECTO: "CONSTRUCCIÓN DE LOS HANGARES DEL GOBIERNO AUTÓNOMO DESCENTRALIZADO PROVINCIAL DE PASTAZA (GADPPz) I ETAPA, PARROQUIA FÁTIMA, CANTÓN Y PROVINCIA DE PASTAZA "

RUBRO	780	ANEXO: 1
DESCRIPCION	CERRADURA ELECTROMAGNETICA 600LB	
UNIDAD	u	
PERIODO	1 DE JUNIO 2021 A 30 DE JUNIO 2021	

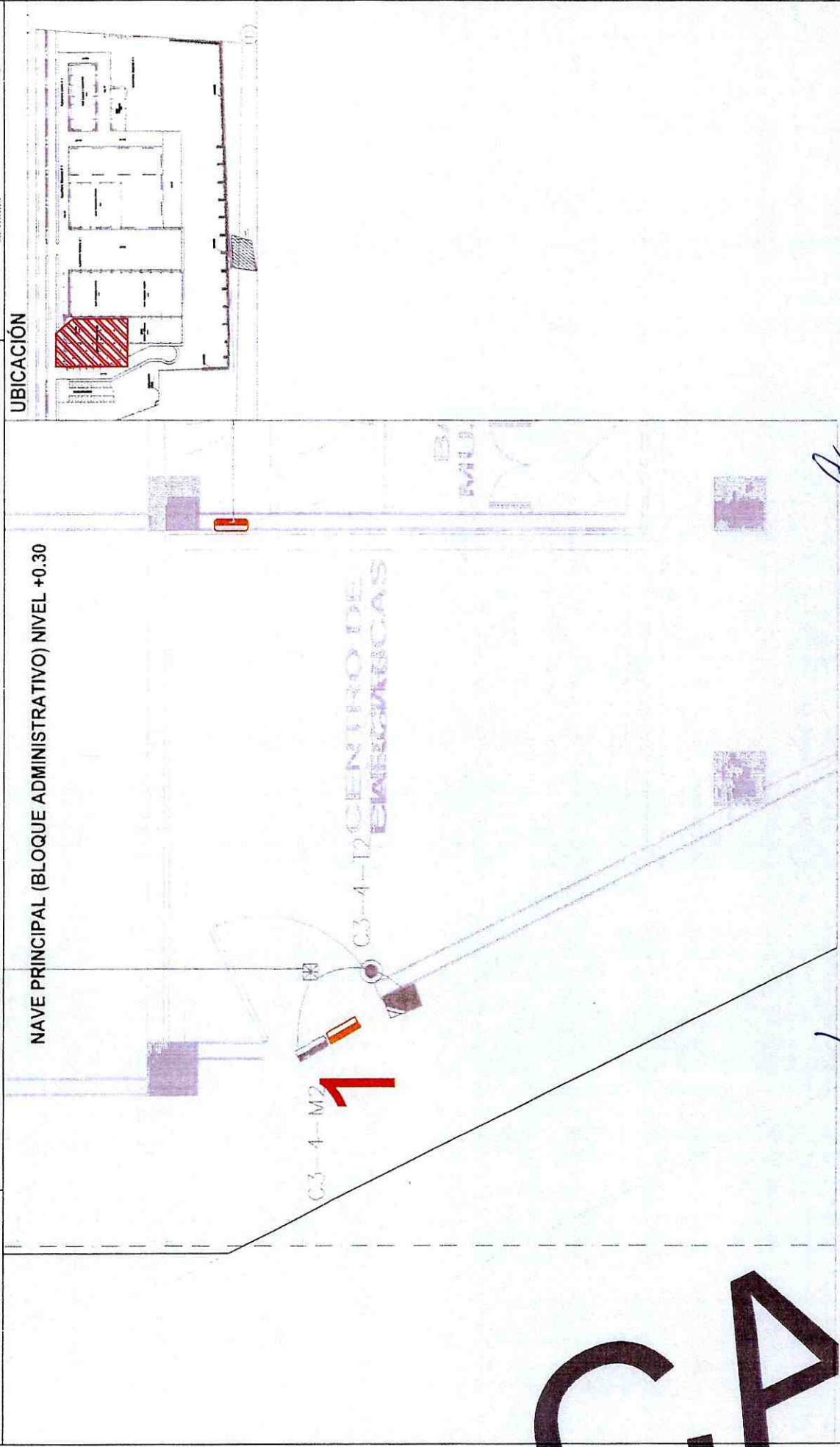

CONTRATISTA

FISCALIZACIÓN

GOBIERNO AUTONOMO DESCENTRALIZADO DE LA
PROVINCIA DEL PASTAZA

PROYECTO: * CONSTRUCCIÓN DE LOS HANGARES DEL GOBIERNO AUTÓNOMO DESCENTRALIZADO PROVINCIAL DE PASTAZA
(GADPPz) I ETAPA, PARROQUIA FÁTIMA, CANTÓN Y PROVINCIA DE PASTAZA *

RUBRO	780	ANEXO: 1
DESCRIPCION	CERRADURA ELECTROMAGNETICA 600LB	
UNIDAD	U	
PERIODO	1 DE JUNIO 2021 A 30 DE JUNIO 2021	



UBICACIÓN

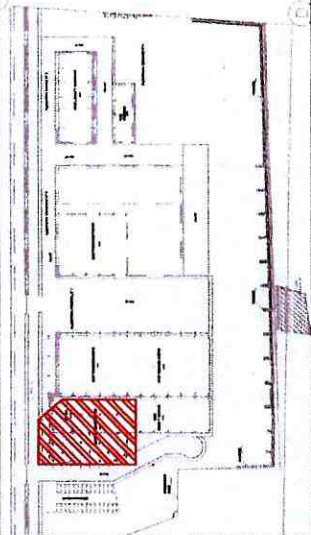

NAVE PRINCIPAL (BLOQUE ADMINISTRATIVO) NIVEL +0.30

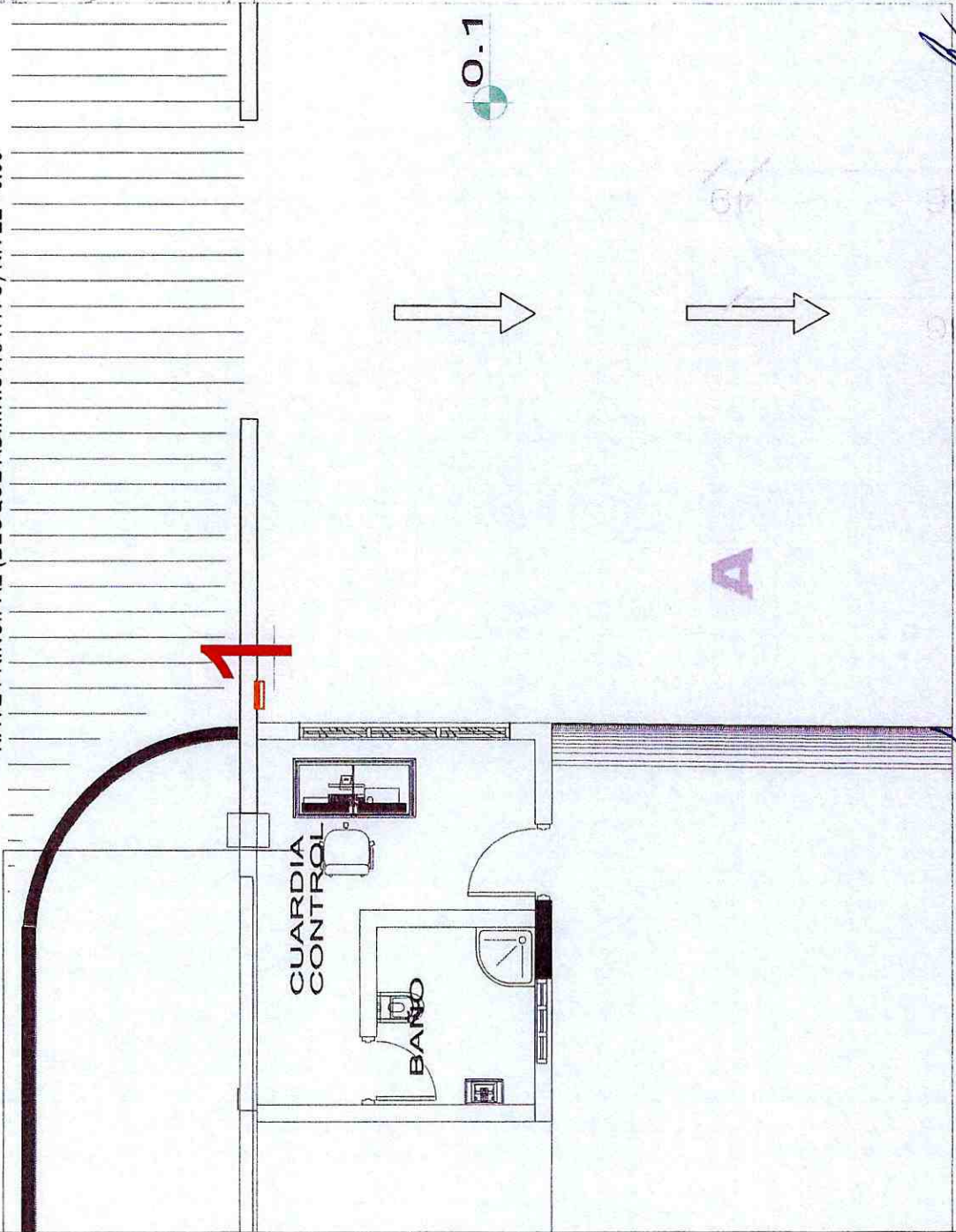

CONTRATISTA

FISCALIZACIÓN

BIERNO AUTONOMO DESCENTRALIZADO DE LA
PROVINCIA DEL PASTAZA

* CONSTRUCCIÓN DE LOS HANGARES DEL GOBIERNO AUTÓNOMO DESCENTRALIZADO PROVINCIAL DE PASTAZA
(GADPPz) I ETAPA, PARROQUIA FÁTIMA, CANTÓN Y PROVINCIA DE PASTAZA *



RUBRO	780	ANEXO: 1
DESCRIPCION	CERRADURA ELECTROMAGNETICA 600LB	
UNIDAD	U	
PERIODO	1 DE JUNIO 2021 A 30 DE JUNIO 2021	

UBICACIÓN

NAVE LAVADO (LAVADO Y ENGRASADO) NIVEL +0.30

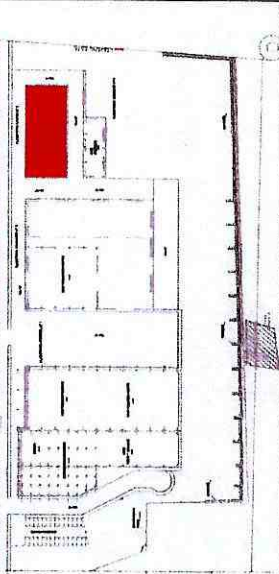

pm_20



112

VULCANIZADOR

[Signature]
FISCALIZACIÓN

[Signature]
CONTRATISTA

GOBIERNO AUTÓNOMO DESCENTRALIZADO DE LA PROVINCIA DEL PASTAZA

" CONSTRUCCIÓN DE LOS HANGARES DEL GOBIERNO AUTÓNOMO DESCENTRALIZADO PROVINCIAL DE PASTAZA (GADPPz) I ETAPA, PARROQUIA FÁTIMA, CANTÓN Y PROVINCIA DE PASTAZA "



RUBRO	781	ANEXO: 1
DESCRIPCION	PULSANTE DE SALIDA PARA CONTROL DE ACCESOS	
UNIDAD	U	
PERIODO	1 DE JUNIO 2021 A 30 DE JUNIO 2021	

PROYECTO:

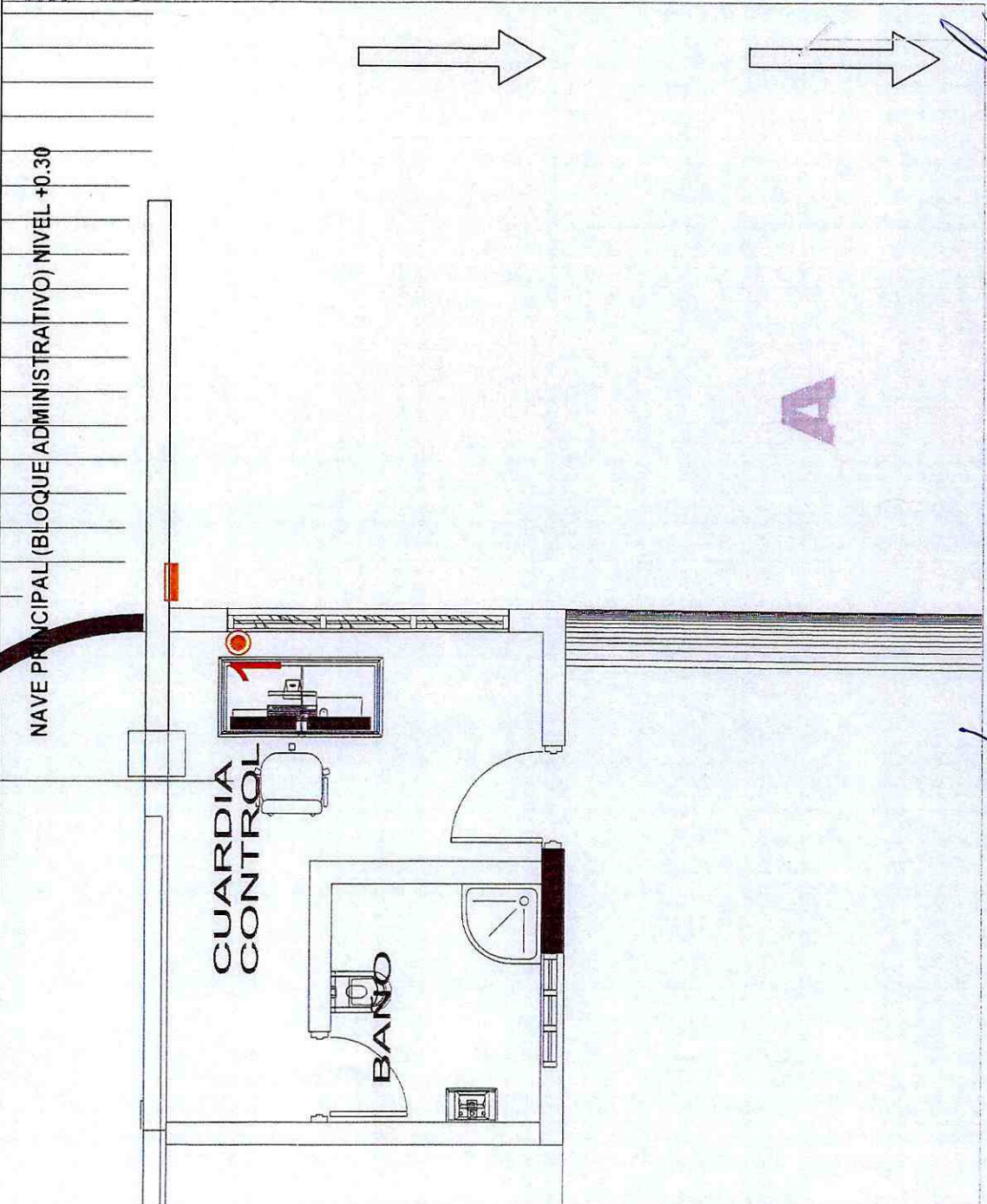

UBICACIÓN

NAVE PRINCIPAL (BLOQUE ADMINISTRATIVO) NIVEL +0.30

GUARDIA CONTROL

BAÑO

A

CONTRATISTA

FISCALIZACIÓN

GOBIERNO AUTÓNOMO DESCENTRALIZADO DE LA PROVINCIA DEL PASTAZA

* CONSTRUCCIÓN DE LOS HANGARES DEL GOBIERNO AUTÓNOMO DESCENTRALIZADO PROVINCIAL DE PASTAZA (GADPPz) I ETAPA, PARROQUIA FATIMA, CANTÓN Y PROVINCIA DE PASTAZA *



RUBRO	781	ANEXO: 1
DESCRIPCION	Pulsante de salida para control de accesos	
UNIDAD	u	
PERIODO	1 DE JUNIO 2021 A 30 DE JUNIO 2021	

NAVE LAVADO (LAVADO Y ENGRASADO) NIVEL +0.30

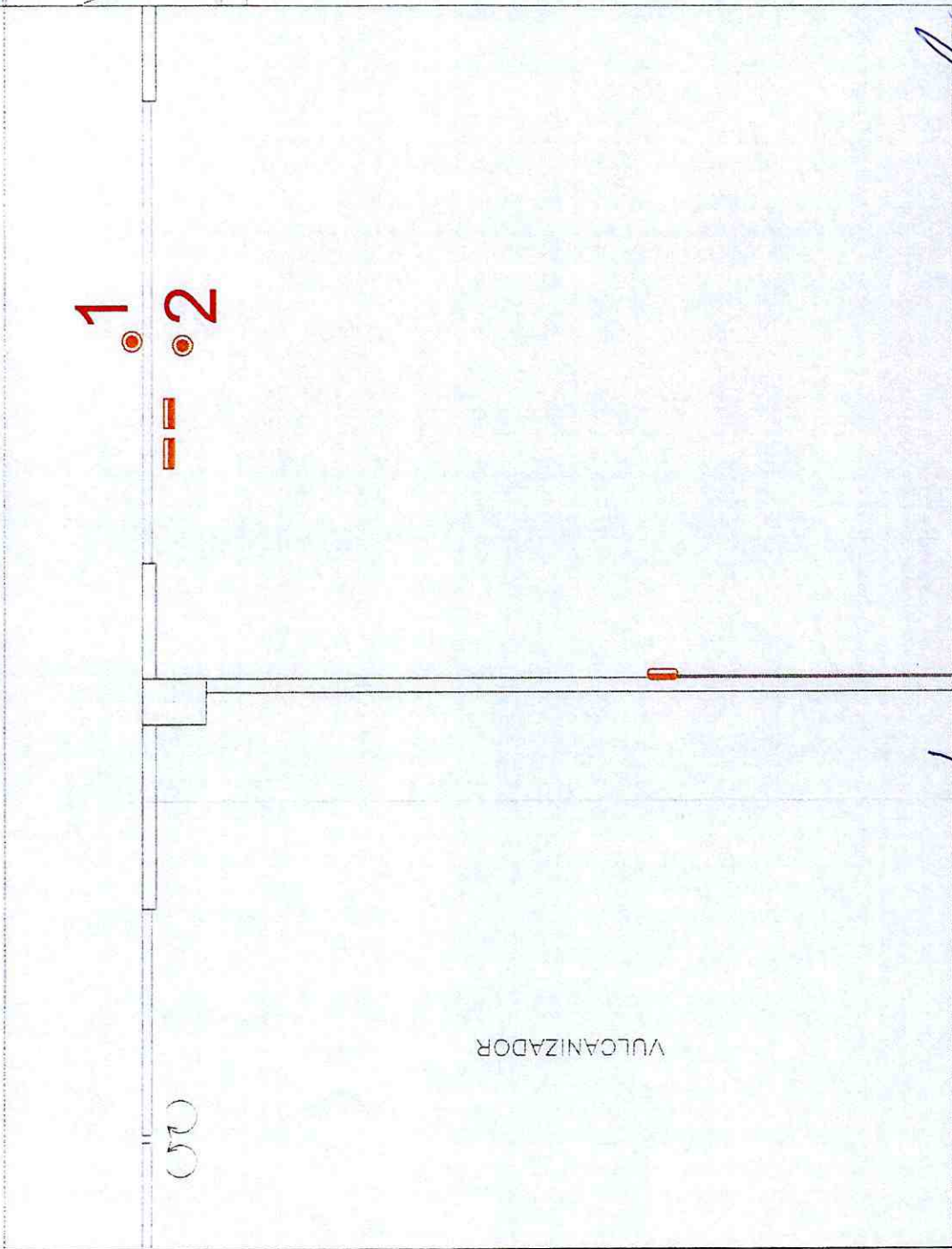

UBICACIÓN

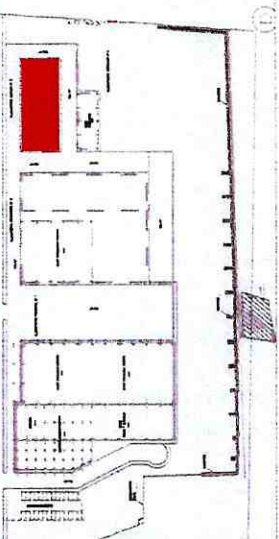

CONTRATISTA

FISCALIZACIÓN

PROYECTO * CONSTRUCCIÓN DE LOS HANGARES DEL GOBIERNO AUTÓNOMO DESCENTRALIZADO PROVINCIAL DE PASTAZA (GADPPz) I ETAPA, PARROQUIA FÁTIMA, CANTÓN Y PROVINCIA DE PASTAZA *
 PLANILLA DE AVANCE DE OBRA No. 23

RUBRO N° 877 ANEXO 1
 DESCRIPCIÓN: CERAmICA COLOR PISO Y PARED ANTIDESLIZANTE 0.30X0.30-INSTAL. Y EmP
 UNIDAD: m2
 PERIODO: 01-may 31-may



CERAmICA COLOR PISO Y PARED ANTIDESLIZANTE 0.30X0.30-INSTAL. Y EmP						
GARITAS 1-2						
DESCRIPCION	LARGO (X)	ANCHO (Y)	ALTO (Z)	No.	SUBTOTAL	TOTAL
A1	2,20	3,10		1,00	6,82	6,82
	0,90	0,20		1,00	0,18	0,18
	1,40	1,06		1,00	1,48	1,48
	0,70	0,15		2,00	0,11	0,21
	1,25	1,89		1,00	2,36	2,36
A2	2,29	2,20		1,00	5,04	5,04
	0,70	0,20		2,00	0,14	0,28
	1,70	1,20		1,00	2,04	2,04
TOTAL					18,41	

RESUMEN DE PLANILLA AL 100%					
DESCRIPCION	CONTRATADO	ANTERIOR	ACTUAL	ACUMULADO	UNIDAD
CERAmICA COLOR PISO Y PARED ANTIDESLIZANTE 0.30X0.30-INSTAL. Y EmP	38,00	-	18,41	18,41	m2

 CONTRATISTA

 FISCALIZACIÓN

**BIENIO AUTÓNOMO DESCENTRALIZADO DE
PROVINCIA DEL PASTAZA**

" CONSTRUCCIÓN DE LOS HANGARES DEL GOBIERNO AUTÓNOMO DESCENTRALIZADO PROVINCIAL DE PASTAZA
(GADPPz) | ETAPA, PARROQUIA FÁTIMA, CANTÓN Y PROVINCIA DE PASTAZA



PROYECTO:			
RUBRO	877	ANEXO:	1
DESCRIPCION	CERAMICA COLOR PISO Y PARED ANTIDESLIZANTE 0.30X0.30-INSTAL. Y Emp		
UNIDAD	m2		
PERIODO	1 DE JUNIO 2021 A 30 DE JUNIO 2021		

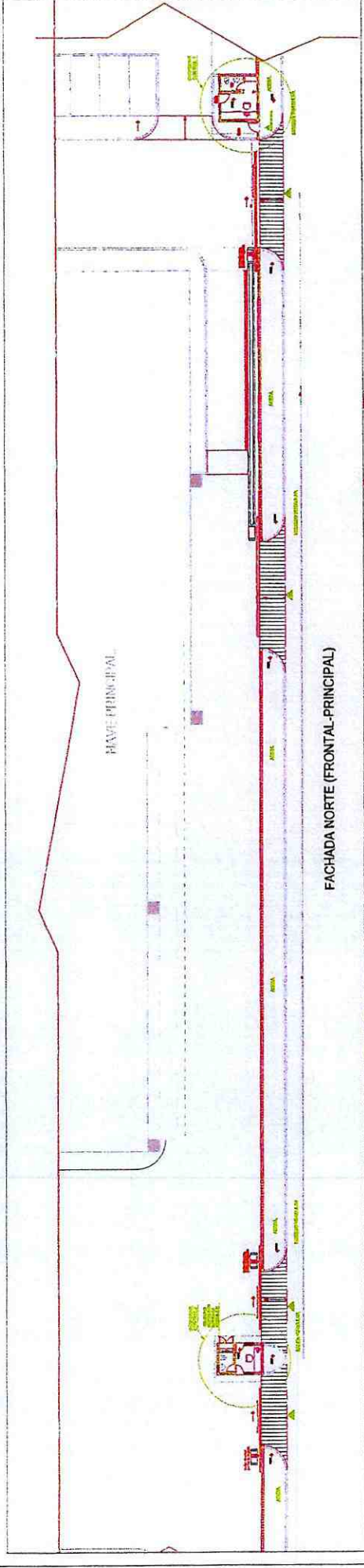

FACHADA NORTE (FRONTAL-PRINCIPAL)

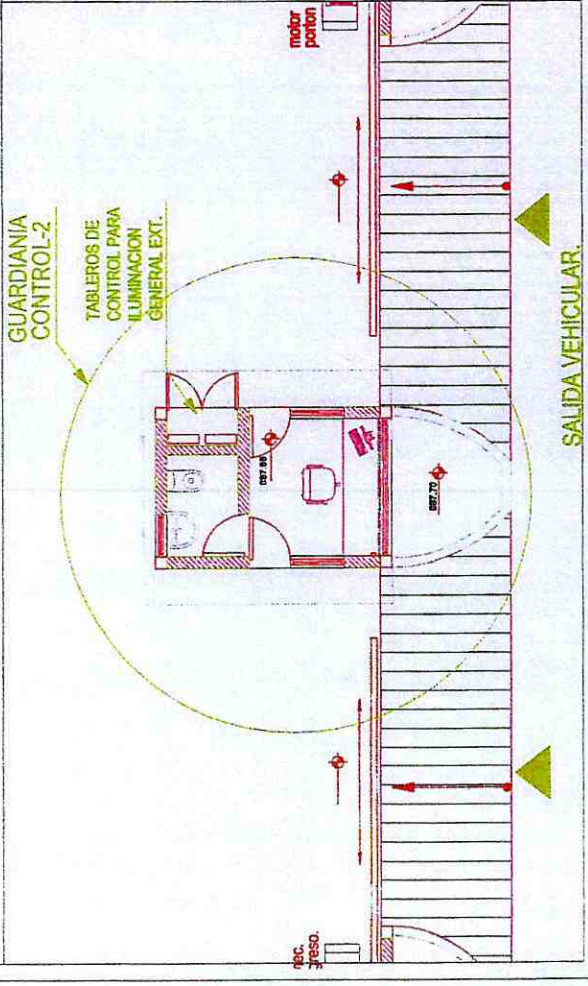
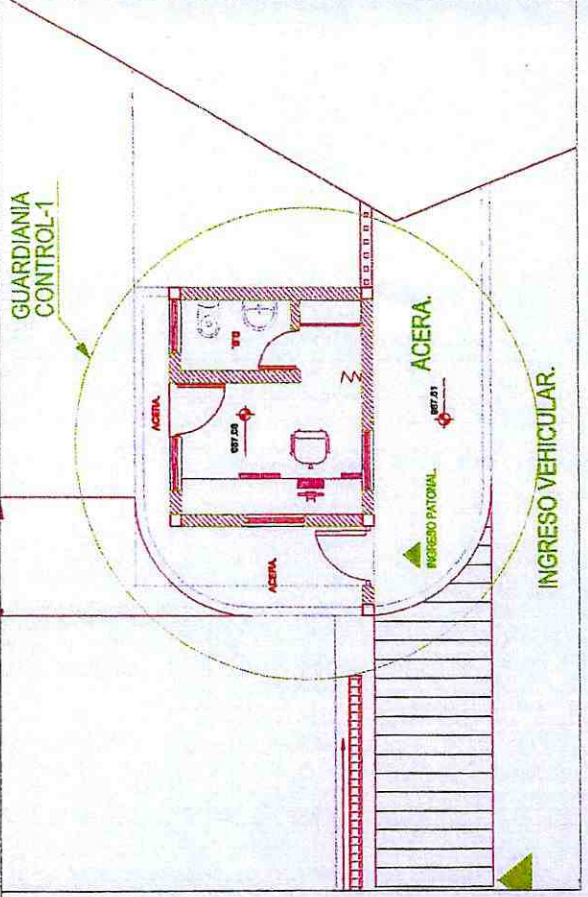

[Signature]
FISCALIZACIÓN

[Signature]
CONTRATISTA

BIEN GOBIERNO AUTONOMO DESCENTRALIZADO DE
 PROVINCIA DEL PASTAZA

" CONSTRUCCIÓN DE LOS HANGARES DEL GOBIERNO AUTÓNOMO DESCENTRALIZADO PROVINCIAL DE PASTAZA
 (GADPPP) I ETAPA, PARROQUIA FÁTIMA, CANTÓN Y PROVINCIA DE PASTAZA"

ANEXO: 2

877 CERAMICA COLOR PISO Y PARED ANTIDESLIZANTE 0.30X0.30-INSTAL. Y Emp

m2

1 DE JUNIO 2021 A 30 DE JUNIO 2021

PROYECTO:

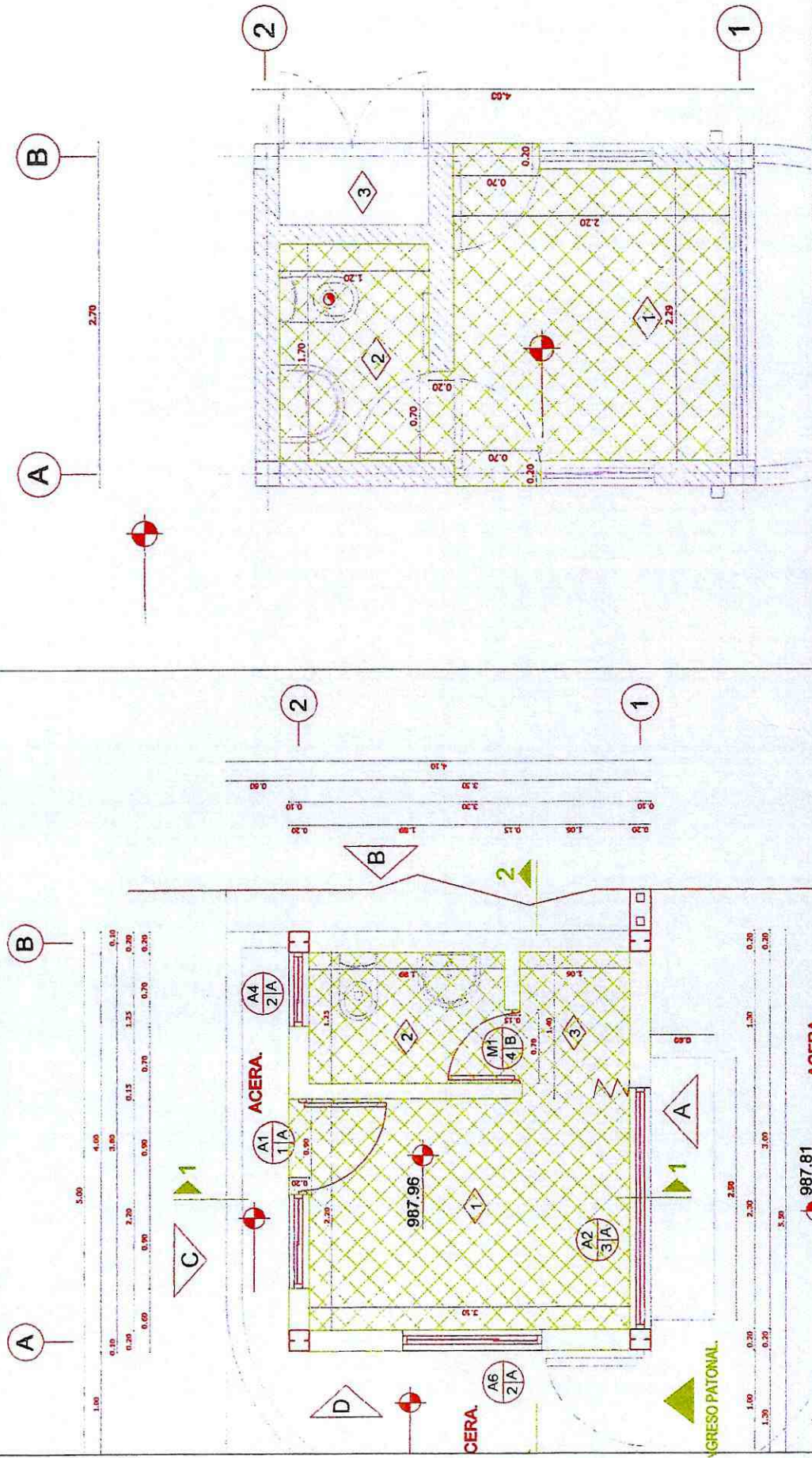

FISCALIZACIÓN

CONTRATISTA

GOBIERNO AUTÓNOMO DESCENTRALIZADO DE LA PROVINCIA DEL PASTAZA

PROYECTO " CONSTRUCCIÓN DE LOS HANGARES DEL GOBIERNO AUTÓNOMO DESCENTRALIZADO PROVINCIAL DE PASTAZA (GADPPz) I ETAPA, PARROQUIA FÁTIMA, CANTÓN Y PROVINCIA DE PASTAZA "

PLANILLA DE AVANCE DE OBRA No. 23

RUBRO N° 887

ANEXO 1

DESCRIPCIÓN: PICADO Y RESANADO DE mAmPOSTERIA PARA INSTALACIONES

UNIDAD: m

PERIODO: 01-jun 30-jun



1 DE 1

PICADO Y RESANE DE INSTALACIONES GARITAS 1-2						
DESCRIPCION	LARGO (X)	ANCHO (Y)	ALTO (Z)	No.	SUBTOTAL	TOTAL
PICADO Y CORCHADO DE TUBERIAS PARA INSTALACIONES						

TUB DE AGUA			2,50	2,00	5,00	5,00
					SUBTOTAL 1	5,00

PICADO Y CORCHADO DE TUBERIAS PARA INSTALACIONES						
--	--	--	--	--	--	--

TUB DE DESAGUE			2,50	2,00	5,00	5,00
					SUBTOTAL 2	5,00

PICADO Y CORCHADO DE TUBERIAS PARA INSTALACIONES ELECTRICAS ELECTRONICAS						
--	--	--	--	--	--	--

TUB DE FUERZA			2,70	8,00	21,60	21,60
TUB DE ILUMINACIÓN			1,85	10,00	18,50	18,50
CANALETA			2,26	1,00	2,26	2,26
					SUBTOTAL 3	42,36

RESUMEN DE PLANILLA AL 100%					
DESCRIPCION	CONTRATADO	ANTERIOR	ACTUAL	ACUMULADO	UNIDAD
PICADO Y RESANADO DE mAmPOSTERIA PARA INSTALACIONES	52,36	-	52,36	52,36	m

CONTRATISTA

FISCALIZACIÓN

**GOBIERNO AUTONOMO DESCENTRALIZADO DE LA
PROVINCIA DEL PASTAZA**

" CONSTRUCCIÓN DE LOS HANGARES DEL GOBIERNO AUTÓNOMO DESCENTRALIZADO PROVINCIAL DE PASTAZA
(GADPPz) | ETAPA, PARROQUIA FÁTIMA, CANTÓN Y PROVINCIA DE PASTAZA."

PROYECTO:			
RUBRO	887	ANEXO:	1
DESCRIPCION	PICADO Y RESANADO DE mAmPOSTERIA PARA INSTALACIONES		
UNIDAD	m		
PERIODO	1 DE JUNIO 2021 A 30 DE JUNIO 2021		

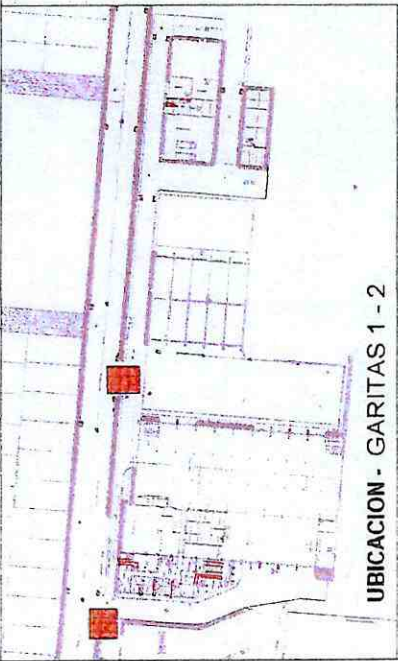

UBICACION - GARITAS 1 - 2

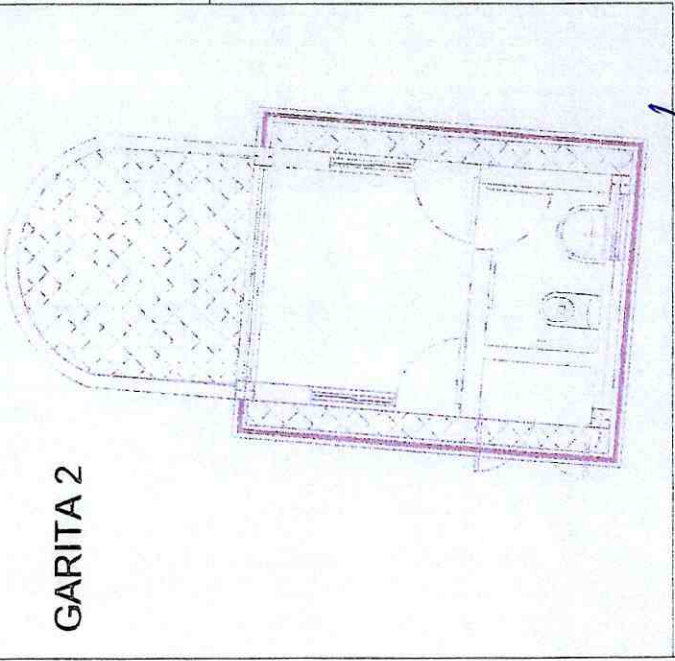

GARITA 2

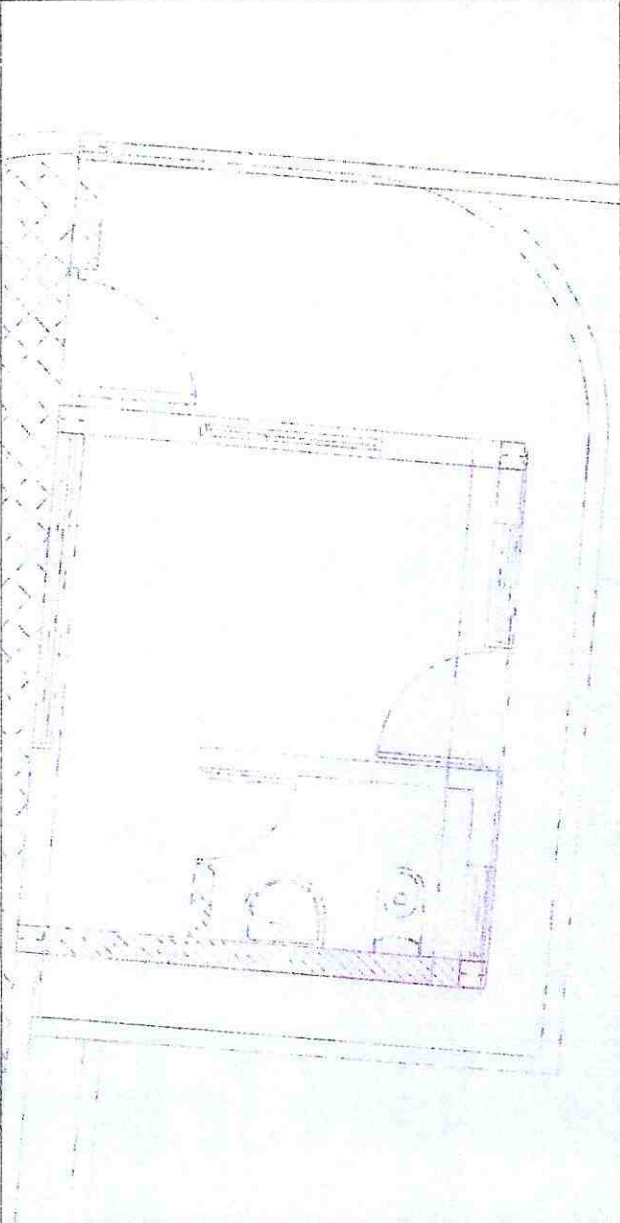

GARITA 1

CONTRATISTA

FISCALIZACIÓN

GOBIERNO AUTÓNOMO DESCENTRALIZADO DE LA PROVINCIA DEL PASTAZA

PROYECTO " CONSTRUCCIÓN DE LOS HANGARES DEL GOBIERNO AUTÓNOMO DESCENTRALIZADO PROVINCIAL DE PASTAZA (GADPPz) I ETAPA, PARROQUIA FÁTIMA, CANTÓN Y PROVINCIA DE PASTAZA "

PLANILLA DE AVANCE DE OBRA No. 23

RUBRO N° 894 ANEXO 1
 DESCRIPCIÓN: PuERTA TAmBORADA 70Cm, ESQuELETO CANELO, mDF 9mm -LACADA-DISEÑO CORPORATIVO
 UNIDAD: u
 PERIODO: 01-jun 30-jun



PAG. 1 DE 1

PuERTA TAmBORADA 70Cm, ESQuELETO CANELO, mDF 9mm -LACADA-DISEÑO CORPORATIVO						
GUARDIA Y CONTROL						
DESCRIPCION	LARGO (X)	ANCHO (Y)	ALTO (Z)	No.	SUBTOTAL	TOTAL
GUARDIA Y CONTROL # 1	0,70		2,10	1,00	1,47	1,47
GUARDIA Y CONTROL # 2	0,70		2,10	1,00	1,47	1,47
GUARDIA Y CONTROL # 3	0,70		2,10	1,00	1,47	1,47
					TOTAL	4,41

RESUMEN DE PLANILLA AL 100%					
DESCRIPCION	CONTRATADO	ANTERIOR	ACTUAL	ACUMULADO	UNIDAD
PuERTA TAmBORADA 70Cm, ESQuELETO CANELO, mDF 9mm - LACADA-DISEÑO CORPORATIVO	4,41	-	4,41	4,41	u

 CONTRATISTA

 FISCALIZACIÓN

**BIERNO AUTONOMO DESCENTRALIZADO DE LA
PROVINCIA DEL PASTAZA**

" CONSTRUCCIÓN DE LOS HANGARES DEL GOBIERNO AUTÓNOMO DESCENTRALIZADO PROVINCIAL DE PASTAZA
(GADPPz) I ETAPA, PARROQUIA FÁTIMA, CANTÓN Y PROVINCIA DE PASTAZA "



RUBRO	894	ANEXO: 1
DESCRIPCION	Puerta Tamborada 70cm, ESQUELETO CANELO, mDF 9mm -LACADA-DISEÑO CORPORATIVO	
UNIDAD	U	
PERIODO	1 DE JUNIO 2021 A 30 DE JUNIO 2021	

PROYECTO:

UBICACION - GUARDIA Y CONTROL # 1 # 2 # 3

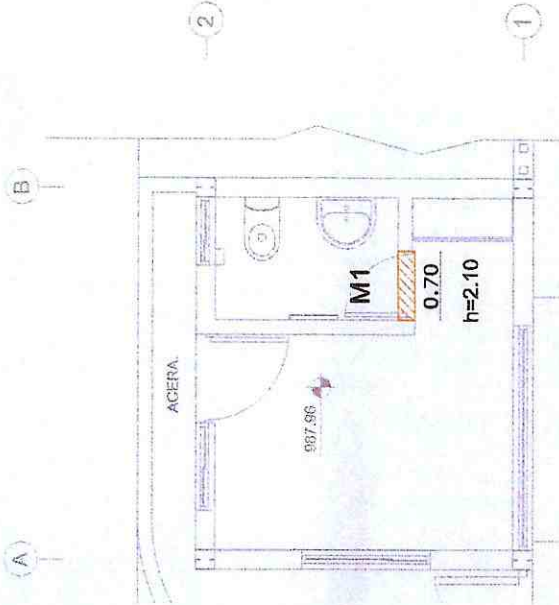
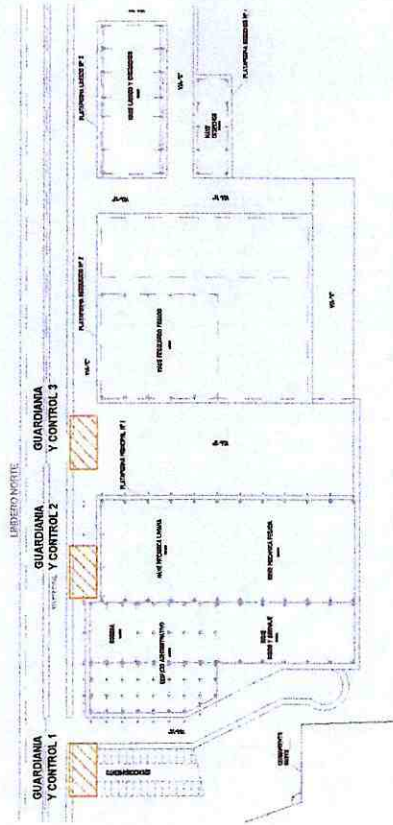

GUARDIANIA Y CONTROL 1 - LAVABO

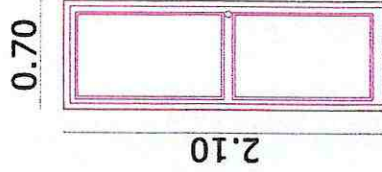

**MARCA-M1 AREA: 1.47 m²
DETALLE PUERTA M1**

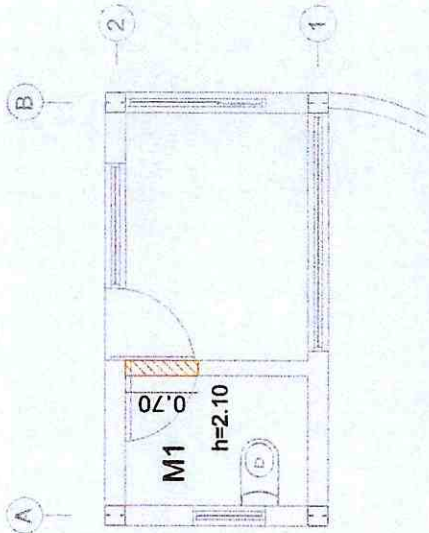

GUARDIANIA Y CONTROL 2 - LAVABO

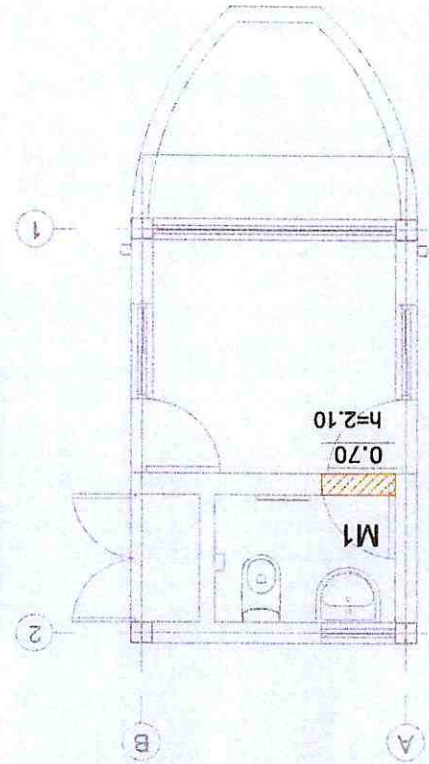

GUARDIANIA Y CONTROL 3 - LAVABO

[Signature]
CONTRATISTA

[Signature]
FISCALIZACIÓN

GOBIERNO AUTÓNOMO DESCENTRALIZADO DE LA PROVINCIA DEL PASTAZA

PROYECTO "CONSTRUCCIÓN DE LOS HANGARES DEL GOBIERNO AUTÓNOMO DESCENTRALIZADO PROVINCIAL DE PASTAZA (GADPPz) I ETAPA, PARROQUIA FÁTIMA, CANTÓN Y PROVINCIA DE PASTAZA"

PLANILLA DE AVANCE DE OBRA No. 23

RUBRO N° 896 ANEXO 1
 DESCRIPCIÓN: INODORO BLANCO (CON ACCESORIOS)
 UNIDAD: u
 PERIODO: 01-jun 30-jun



PAG. 1 DE 1

INODORO BLANCO (CON ACCESORIOS)				
GUARDIA Y CONTROL				
DESCRIPCION	CANTIDAD	DIMENSION	TOTAL	GRAFICO #
GUARDIA Y CONTROL # 1	1,00	-	1,00	ANEXO # 1
GUARDIA Y CONTROL # 2	1,00	-	1,00	ANEXO # 1
			TOTAL	2,00

RESUMEN DE PLANILLA AL 100%					
DESCRIPCION	CONTRATADO	ANTERIOR	ACTUAL	ACUMULADO	UNIDAD
INODORO BLANCO (CON ACCESORIOS)	3,00	-	2,00	2,00	u

 CONTRATISTA

 FISCALIZACIÓN

BIENIO AUTÓNOMO DESCENTRALIZADO DE
PROVINCIA DEL PASTAZA

" CONSTRUCCIÓN DE LOS HANGARES DEL GOBIERNO AUTÓNOMO DESCENTRALIZADO PROVINCIAL DE PASTAZA (GADPPz) | ETAPA, PARROQUIA FÁTIMA, CANTÓN Y PROVINCIA DE PASTAZA "

ANEXO: 1

896

INODORO BLANCO (CON ACCESORIOS)

U

1 DE JUNIO 2021 A 30 DE JUNIO 2021

PROYECTO:

RUBRO

DESCRIPCION

UNIDAD

PERIODO

UBICACION - GUARDIA Y CONTROL # 1 # 2 # 3

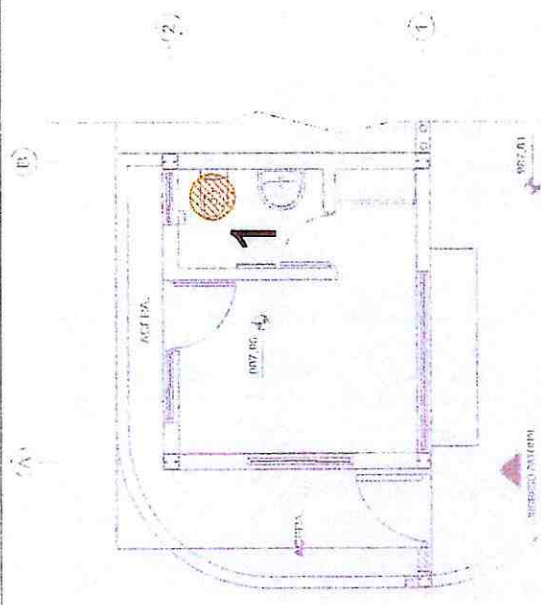
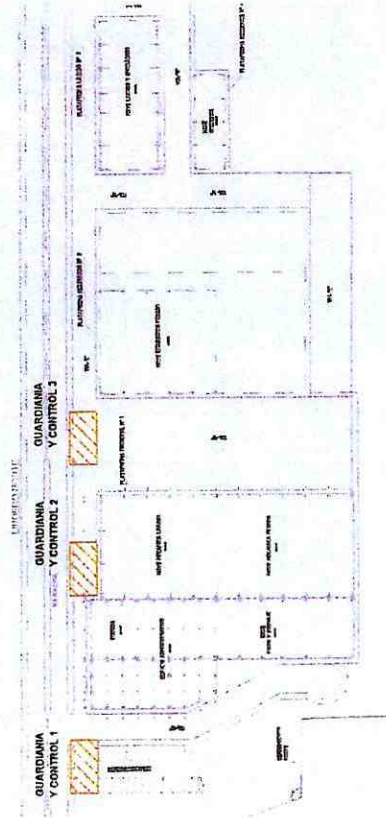

GUARDIANA Y CONTROL 1 - INODORO

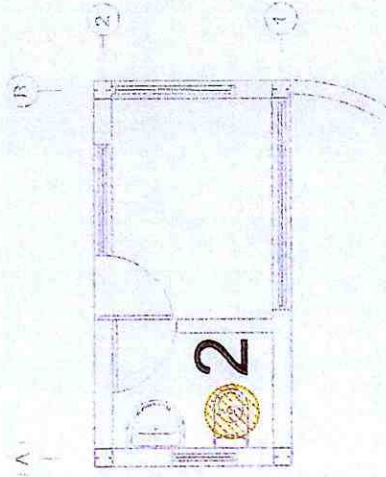

GUARDIANA Y CONTROL 2 - INODORO

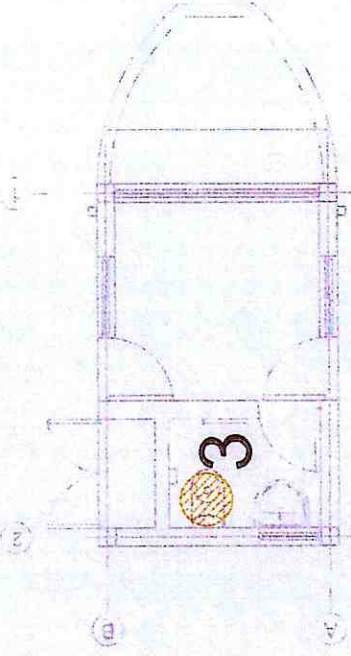

GUARDIANA Y CONTROL 3 - INODORO

CONTRATISTA

FISCALIZACIÓN

PROYECTO " CONSTRUCCIÓN DE LOS HANGARES DEL GOBIERNO AUTÓNOMO DESCENTRALIZADO PROVINCIAL DE PASTAZA (GADPPz) I ETAPA, PARROQUIA FÁTIMA, CANTÓN Y PROVINCIA DE PASTAZA "

PLANILLA DE AVANCE DE OBRA No. 23

RUBRO N° 897 ANEXO 1
 DESCRIPCIÓN: LAVABO BLANCO (CON ACCESORIOS)
 UNIDAD: u
 PERIODO: 01-jun 30-jun



PAG. 1 DE 1

LAVABO BLANCO (CON ACCESORIOS)				
GUARDIA Y CONTROL				
DESCRIPCION	CANTIDAD	DIMENSION	TOTAL	GRAFICO #
GUARDIA Y CONTROL # 1	1,00	-	1,00	ANEXO # 1
GUARDIA Y CONTROL # 2	1,00	-	1,00	ANEXO # 1
			TOTAL	2,00

RESUMEN DE PLANILLA AL 100%					
DESCRIPCION	CONTRATADO	ANTERIOR	ACTUAL	ACUMULADO	UNIDAD
LAVABO BLANCO (CON ACCESORIOS)	3,00	-	2,00	2,00	u

 CONTRATISTA

 FISCALIZACIÓN

PROYECTO: " CONSTRUCCIÓN DE LOS HANGARES DEL GOBIERNO AUTÓNOMO DESCENTRALIZADO PROVINCIAL DE PASTAZA (GADPPz) | ETAPA, PARROQUIA FÁTIMA, CANTÓN Y PROVINCIA DE PASTAZA "



RUBRO	897	ANEXO: 1
DESCRIPCION	LAVABO BLANCO (CON ACCESORIOS)	
UNIDAD	U	
PERIODO	1 DE JUNIO 2021 A 30 DE JUNIO 2021	

UBICACION - GUARDIA Y CONTROL # 1 # 2 # 3

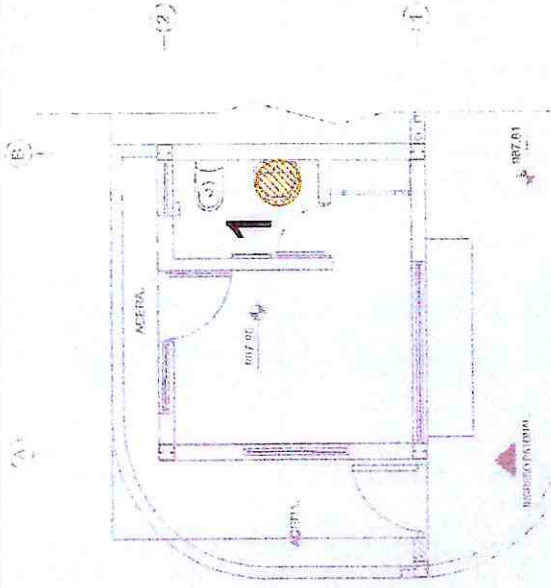
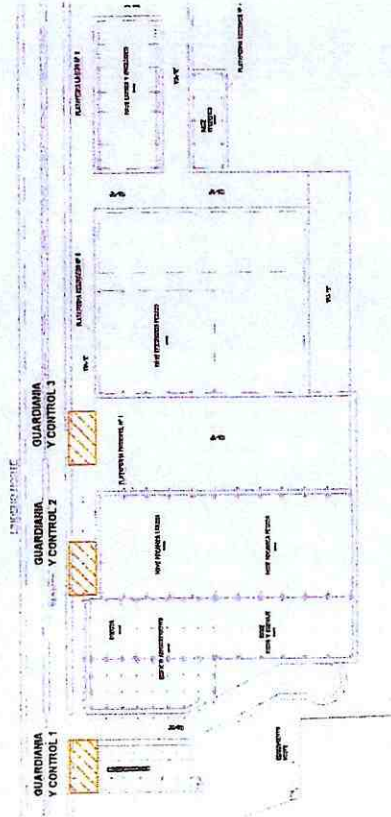

GUARDIANIA Y CONTROL 1 - LAVABO

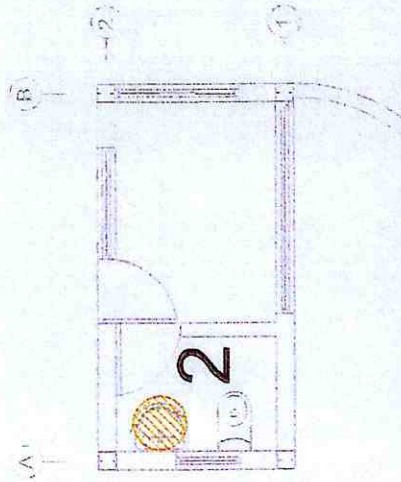

GUARDIANIA Y CONTROL 2 - LAVABO

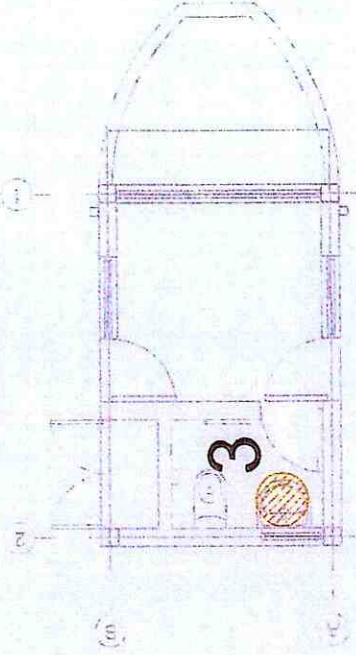

GUARDIANIA Y CONTROL 3 - LAVABO

CONTRATISTA

EJECUTOR

PROYECTO * CONSTRUCCIÓN DE LOS HANGARES DEL GOBIERNO AUTÓNOMO DESCENTRALIZADO PROVINCIAL DE PASTAZA (GADPP2) I ETAPA, PARROQUIA FÁTIMA, CANTÓN Y PROVINCIA DE PLANILLA DE AVANCE DE OBRA No. 23

RUBRO N° 899 ANEXO 1
 DESCRIPCIÓN: ARREGLO Y LIMPIEZA (INCLUYE DESALOJO)
 UNIDAD: m2
 PERIODO: 01-jun 30-jun



ARREGLO Y LIMPIEZA (INCLUYE DESALOJO)						
AREA INTERVENIDA PARA MESETAS Y TALUDES						
DESCRIPCION	LARGO (X)	ANCHO (Y)	ALTO (Z)	No.	SUBTOTAL	TOTAL
AREA	147,91	27,12		1	4011,32	4011,32
TOTAL 1					4.011,32	4.011,32

RESUMEN DE PLANILLA AL 100%					
DESCRIPCION	CONTRATADO	ANTERIOR	ACTUAL	ACUMULADO	UNIDAD
ARREGLO Y LIMPIEZA (INCLUYE DESALOJO)	1.765,78	-	1.765,78	1.765,78	m2

RESUMEN DE PLANILLA DE INCREMENTOS						
DESCRIPCION	CONTRATADO	ANTERIOR	ACTUAL	INCR. ANT.	INCR. ACT.	UNIDAD
ARREGLO Y LIMPIEZA (INCLUYE DESALOJO)	1.765,78	0,00			2.245,54	m2



 CONTRATISTA



 FISCALIZACIÓN

**GOBIERNO AUTÓNOMO DESCENTRALIZADO DE LA
PROVINCIA DEL PASTAZA**

" CONSTRUCCIÓN DE LOS HANGARES DEL GOBIERNO AUTÓNOMO DESCENTRALIZADO PROVINCIAL DE PASTAZA
(GADPPZ) I ETAPA, PARROQUIA FÁTIMA, CANTÓN Y PROVINCIA DE PASTAZA "

PROYECTO:

RUBRO	899	ANEXO: 1
DESCRIPCION	ARREGLO Y LIMPIEZA (INCLUYE DESALOJO)	
UNIDAD	m ²	
PERIODO	1 DE JUNIO 2021 A 30 DE JUNIO 2021	

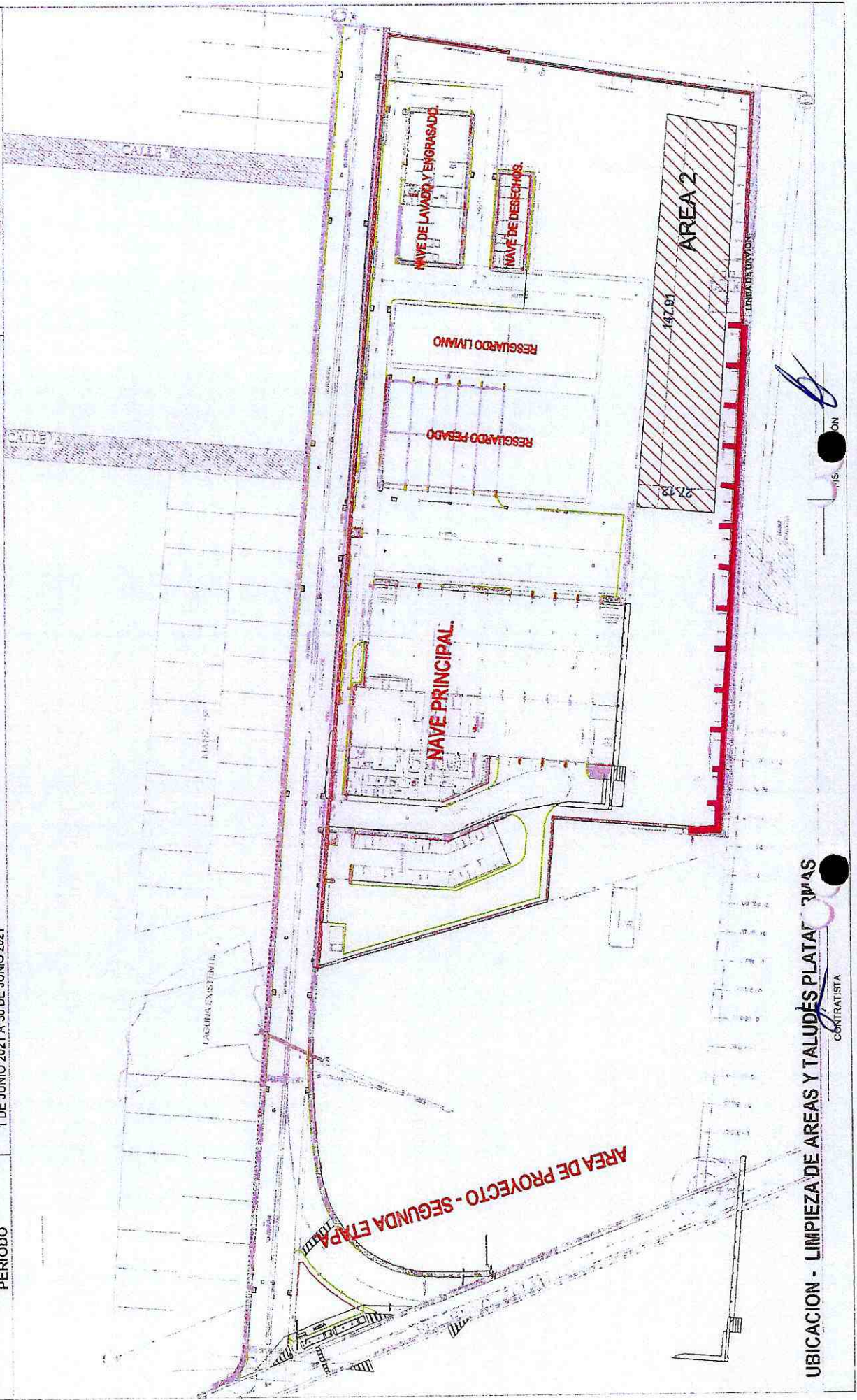

UBICACION - LIMPIEZA DE AREAS Y TALUDES PLATAFORMAS
CONTRATISTA

GOBIERNO AUTÓNOMO DESCENTRALIZADO DE LA PROVINCIA DEL PASTAZA

PROYECTO * CONSTRUCCIÓN DE LOS HANGARES DEL GOBIERNO AUTÓNOMO DESCENTRALIZADO PROVINCIAL DE PASTAZA (GADPPz) I ETAPA, PARROQUIA FÁTIMA, CANTÓN Y PROVINCIA DE PLANILLA DE AVANCE DE OBRA No. 23

RUBRO N° 901 ANEXO 1
 DESCRIPCIÓN: EXCAVACION SIN CLASIFICAR (A mAQuINA)
 UNIDAD: m3
 PERIODO: 01-jun 30-jun



PAG. 1 DE 1

EXCAVACION SIN CLASIFICAR (A mAQuINA)						
EXCAVACION DE CERRAMIENTO PERIMETRAL						
DESCRIPCION	LARGO (X)	ANCHO (Y)	ALTO (Z)	No.	SUBTOTAL	TOTAL
TRAMO 1	28,84	1,20	0,80	1,00	27,69	27,69
	84,21	1,20	0,80	1,00	80,84	80,84
TRAMO 2	323,20	1,20	0,80	1,00	310,27	310,27
TRAMO 3	43,45	1,20	0,80	1,00	41,71	41,71
TOTAL						460,51

RESUMEN DE PLANILLA AL 100%					
DESCRIPCION	CONTRATADO	ANTERIOR	ACTUAL	ACUMULADO	UNIDAD
EXCAVACION SIN CLASIFICAR (A mAQuINA)	671,86	-	460,51	460,51	m3

 CONTRATISTA

 FISCALIZACIÓN

G ERNO AUTONOMO DESCENTRALIZADO DE L.
PROVINCIA DEL PASTAZA

* CONSTRUCCIÓN DE LOS HANGARES DEL GOBIERNO AUTÓNOMO DESCENTRALIZADO PROVINCIAL DE PASTAZA
 (GADPPz) I ETAPA, PARROQUIA FÁTIMA, CANTÓN Y PROVINCIA DE PASTAZA *



ANEXO: 1

RUBRO	901
DESCRIPCIÓN	EXCAVACION SIN CLASIFICAR (A máquina)
UNIDAD	m ³
PERIODO	1 DE JUNIO 2021 A 30 DE JUNIO 2021

CERRAMIENTO MALLA OESTE

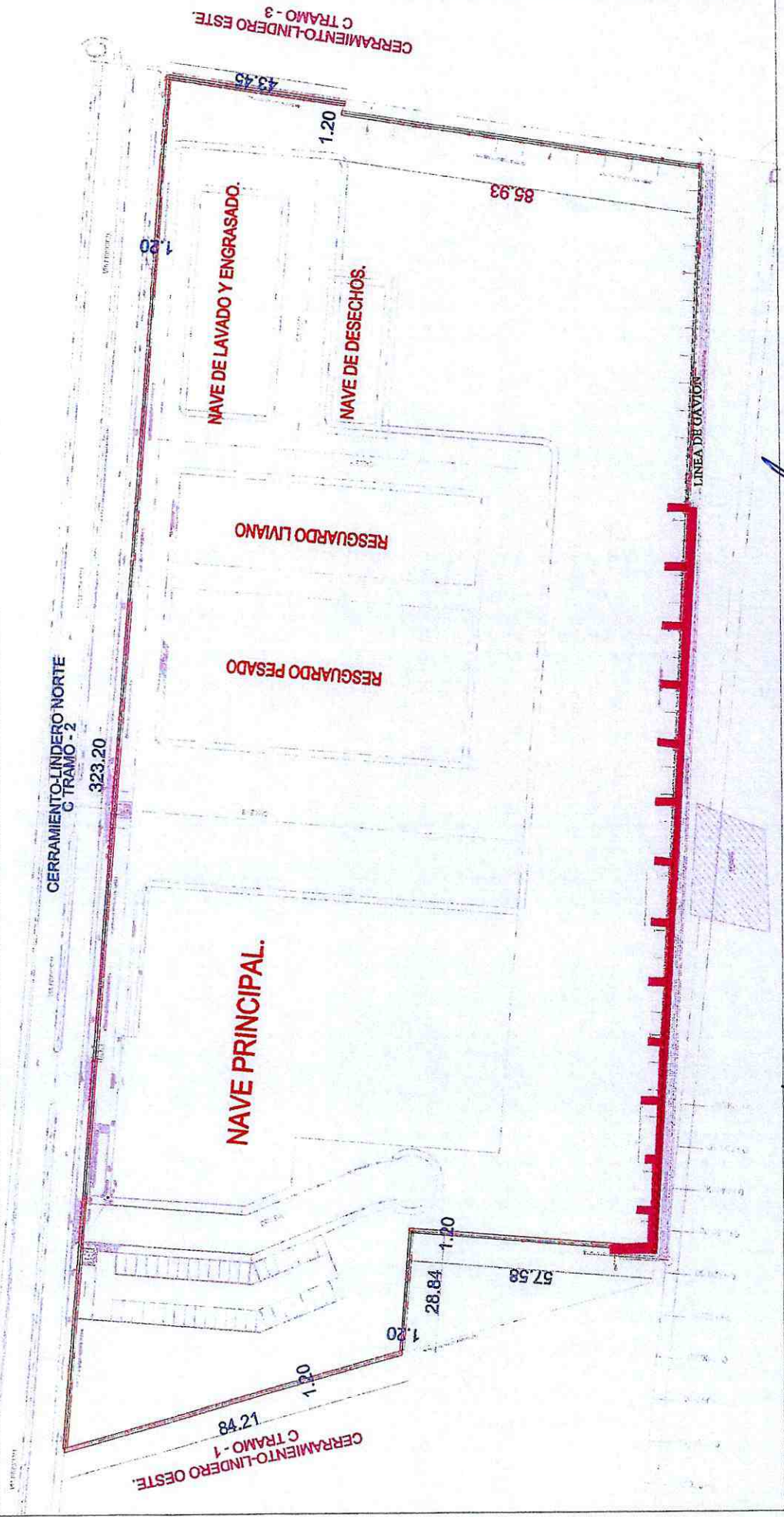

CERRAMIENTO OESTE TRAMO 1

CONTRATISTA

FIRMA

"CONSTRUCCIÓN DE LOS HANGARES DEL GOBIERNO AUTÓNOMO DESCENTRALIZADO PROVINCIAL DE PASTAZA
(GADPPz) I ETAPA, PARROQUIA FÁTIMA, CANTÓN Y PROVINCIA DE PASTAZA."



ANEXO: 2

RUBRO	901
DESCRIPCION	EXCAVACION SIN CLASIFICAR (A maQUINA)
UNIDAD	m ³
PERIODO	1 DE JUNIO 2021 A 30 DE JUNIO 2021

CERRAMIENTO MALLA OESTE

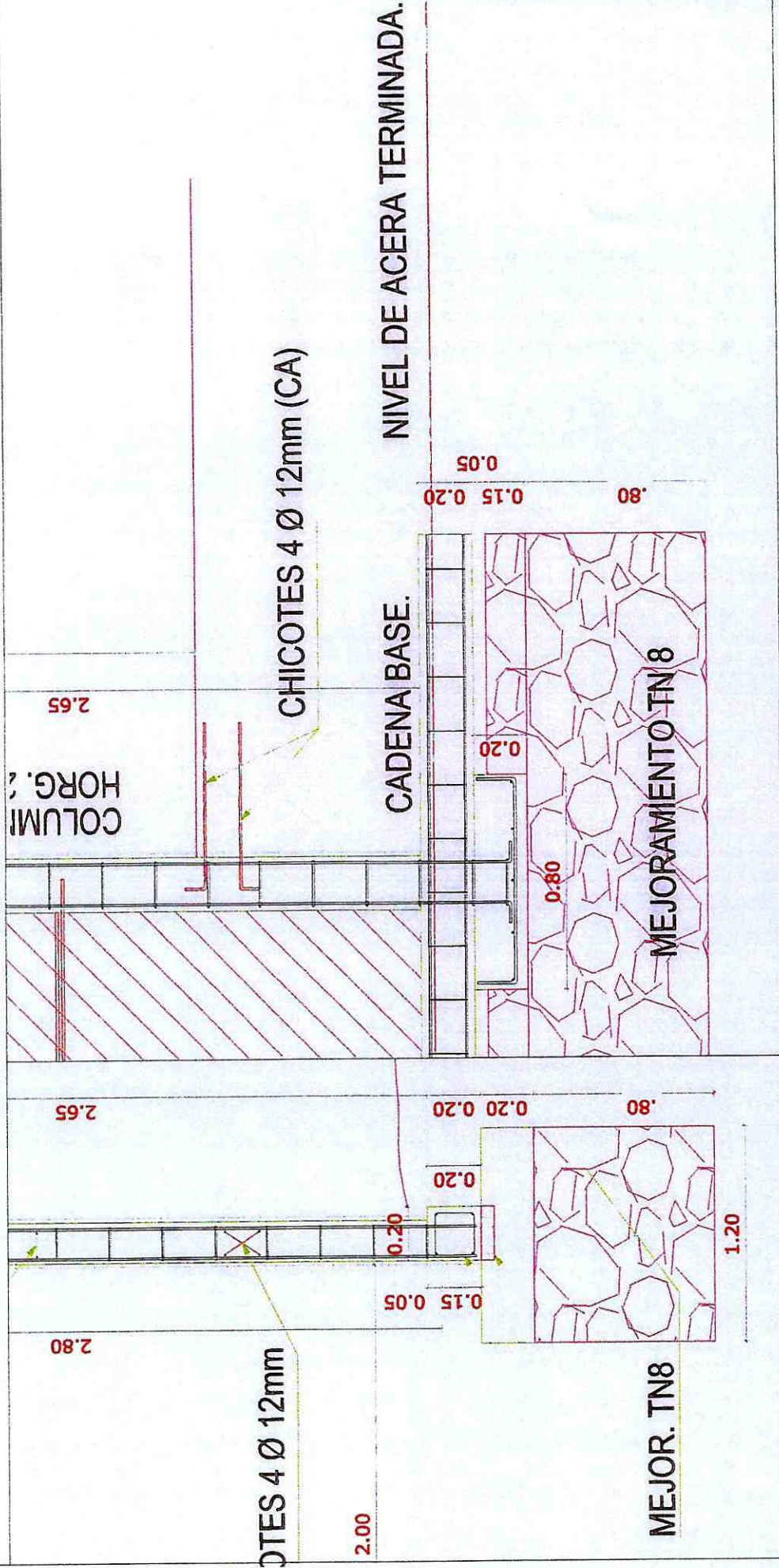

SECCION DE CORTE CERRAMIENTO

FIRMA

CONTRATISTA

GOBIERNO AUTÓNOMO DESCENTRALIZADO DE LA PROVINCIA DEL PASTAZA

PROYECTO " CONSTRUCCIÓN DE LOS HANGARES DEL GOBIERNO AUTÓNOMO DESCENTRALIZADO PROVINCIAL DE PASTAZA (GADPPz) I ETAPA, PARROQUIA FÁTIMA, CANTÓN Y PROVINCIA DE PLANILLA DE AVANCE DE OBRA No. 23

RUBRO N° 903 ANEXO 1
 DESCRIPCIÓN: RELLENO COMPACTADO A mAQUINA CON LASTRE TNm=8" (EN CAPAS DE 20 Cm)
 UNIDAD: m3
 PERIODO: 01-jun 30-jun



PAG. 1 DE 1

RELLENO COMPACTADO A mAQUINA CON LASTRE TNm=8" (EN CAPAS DE 20 Cm)						
EXCAVACION DE CERRAMIENTO PERIMETRAL						
DESCRIPCION	LARGO (X)	ANCHO (Y)	ALTO (Z)	No.	SUBTOTAL	TOTAL
TRAMO 1	28,84	1,20	0,80	1,00	27,69	27,69
	84,21	1,20	0,80	1,00	80,84	80,84
	57,58	1,20	0,80	1,00	55,28	55,28
TRAMO 2	323,20	1,20	0,80	1,00	310,27	310,27
TRAMO 3	43,45	1,20	0,80	1,00	41,71	41,71
TOTAL						515,79

RESUMEN DE PLANILLA AL 100%					
DESCRIPCION	CONTRATADO	ANTERIOR	ACTUAL	ACUMULADO	UNIDAD
RELLENO COMPACTADO A mAQUINA CON LASTRE TNm=8" (EN CAPAS DE 20 Cm)	404,00	-	404,00	404,00	m3

RESUMEN DE PLANILLA DE INCREMENTOS						
DESCRIPCION	CONTRATADO	ANTERIOR	ACTUAL	INCR. ANT.	INCR. ACT.	UNIDAD
RELLENO COMPACTADO A mAQUINA CON LASTRE TNm=8" (EN CAPAS DE 20 Cm)	404,00	0,00			111,79	m3

 CONTRATISTA

 FISCALIZACIÓN

G **BIERNO AUTONOMO DESCENTRALIZADO DE LA PROVINCIA DEL PASTAZA**

"CONSTRUCCIÓN DE LOS HANGARES DEL GOBIERNO AUTÓNOMO DESCENTRALIZADO PROVINCIAL DE PASTAZA (GADPPZ) | ETAPA, PARROQUIA FÁTIMA, CANTÓN Y PROVINCIA DE PASTAZA "

PROYECTO:

903	RELLENO COMPACTADO A MÁQUINA CON LASTRE T _{lim=8"} (EN CAPAS DE 20 Cm)	ANEXO: 1
m ³		
PERIODO	1 DE JUNIO 2021 A 30 DE JUNIO 2021	

CERRAMIENTO MALLA OESTE

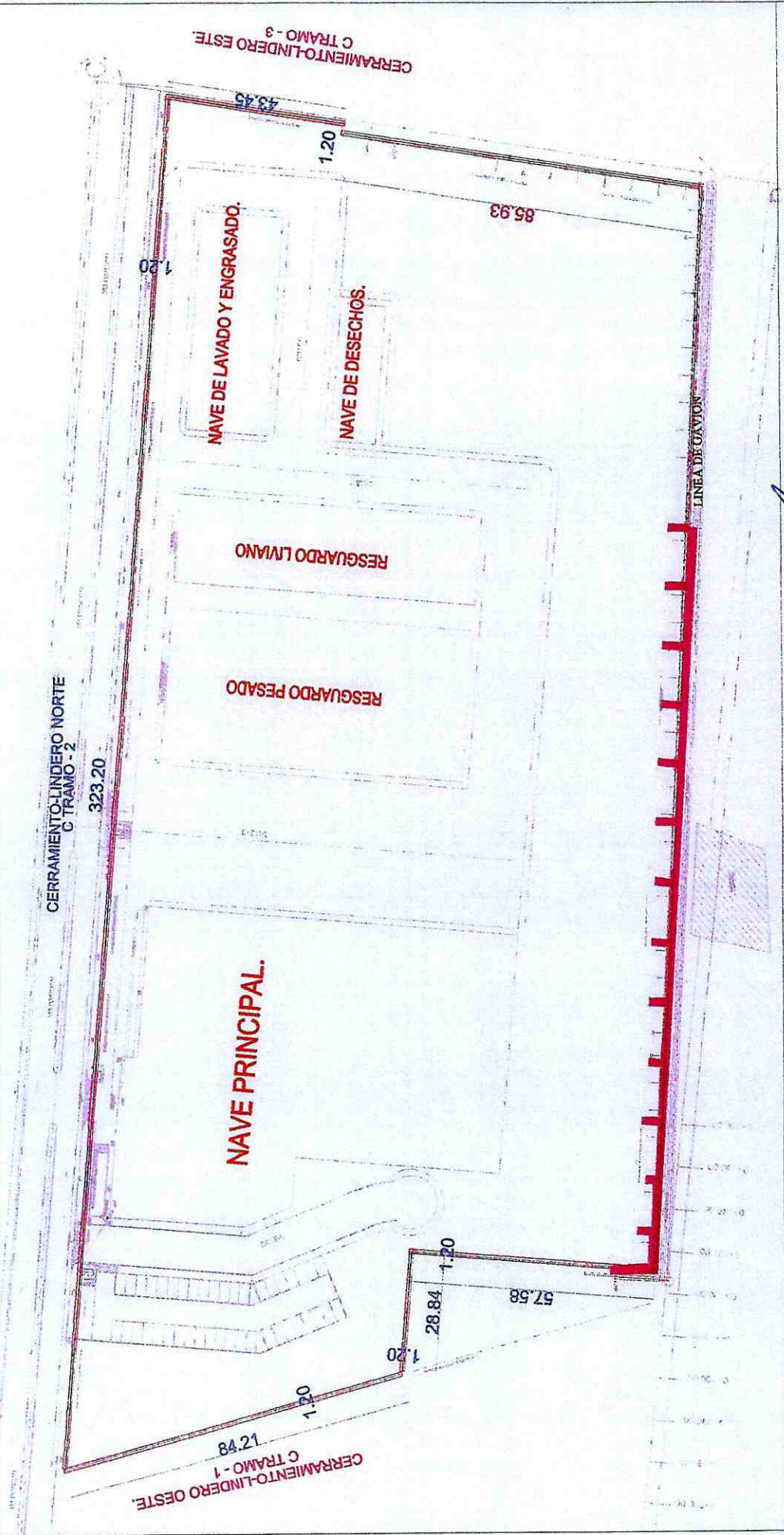

CONTRATISTA

CERRAMIENTO OESTE TRAMO 1

ENCARGADO

GOBIERNO AUTÓNOMO DESCENTRALIZADO DE LA
PROVINCIA DEL PASTAZA

"CONSTRUCCIÓN DE LOS HANGARES DEL GOBIERNO AUTÓNOMO DESCENTRALIZADO PROVINCIAL DE PASTAZA
(GADPPz) I ETAPA, PARROQUIA FÁTIMA, CANTÓN Y PROVINCIA DE PASTAZA"



PROYECTO:

RUBRO	903
DESCRIPCIÓN	RELLENO COMPACTADO A MÁQUINA CON LASTRE TNm=8" (EN CAPAS DE 20 Cm)
UNIDAD	m ³
PERIODO	1 DE JUNIO 2021 A 30 DE JUNIO 2021

ANEXO: 2

CERRAMIENTO MALLA OESTE

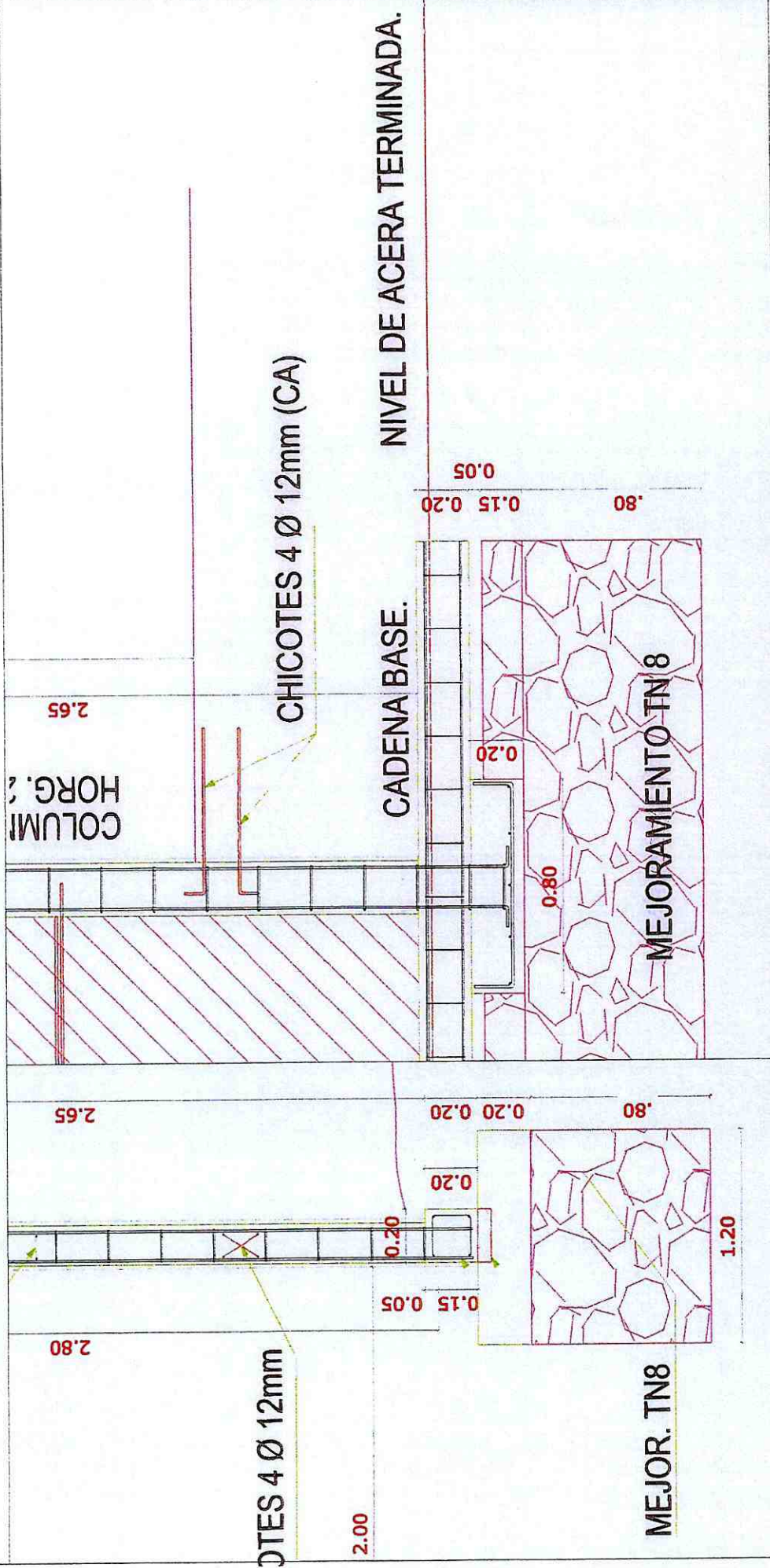

SECCION DE CORTE CERRAMIENTO

CONTRATISTA

FIRMACIÓN

GOBIERNO AUTÓNOMO DESCENTRALIZADO DE LA PROVINCIA DEL PASTAZA

PROYECTO * CONSTRUCCIÓN DE LOS HANGARES DEL GOBIERNO AUTÓNOMO DESCENTRALIZADO PROVINCIAL DE PASTAZA (GADPPz) I ETAPA, PARROQUIA FÁTIMA, CANTÓN Y PROVINCIA DE PLANILLA DE AVANCE DE OBRA No. 23

RUBRO N° 904 ANEXO 1
 DESCRIPCIÓN: DESALOJO MECANICO VOLQUETA TIERRA/ESCOMBROS
 UNIDAD: m³
 PERIODO: 01-jun 30-jun



PAG. 1 DE 1

DESALOJO MECANICO VOLQUETA TIERRA/ESCOMBROS						
EXCAVACION DE CERRAMIENTO PERIMETRAL						
DESCRIPCION	LARGO (X)	ANCHO (Y)	ALTO (Z)	No.	SUBTOTAL	TOTAL
TRAMO 1	28,84	1,20	0,80	1,00	27,69	27,69
	84,21	1,20	0,80	1,00	80,84	80,84
TRAMO 2	323,20	1,20	0,80	1,00	310,27	310,27
TRAMO 3	43,45	1,20	0,80	1,00	41,71	41,71
TOTAL 3					460,51	460,51

RESUMEN DE PLANILLA AL 100%					
DESCRIPCION	CONTRATADO	ANTERIOR	ACTUAL	ACUMULADO	UNIDAD
DESALOJO MECANICO VOLQUETA TIERRA/ESCOMBROS	671,86	-	460,51	460,51	m ³

CONTRATISTA

FISCALIZACIÓN

G. GOBIERNO AUTÓNOMO DESCENTRALIZADO DE LA PROVINCIA DEL PASTAZA

" CONSTRUCCIÓN DE LOS HANGARES DEL GOBIERNO AUTÓNOMO DESCENTRALIZADO PROVINCIAL DE PASTAZA (GADPPZ) I ETAPA, PARROQUIA FÁTIMA, CANTÓN Y PROVINCIA DE PASTAZA "

ANEXO: 1

RUBRO	904
DESCRIPCION	DESALOJO MECANICO VOLQUETA TIERRA ESCOMBROS
UNIDAD	m3
PERIODO	1 DE JUNIO 2021 A 30 DE JUNIO 2021

CERRAMIENTO MALLA OESTE

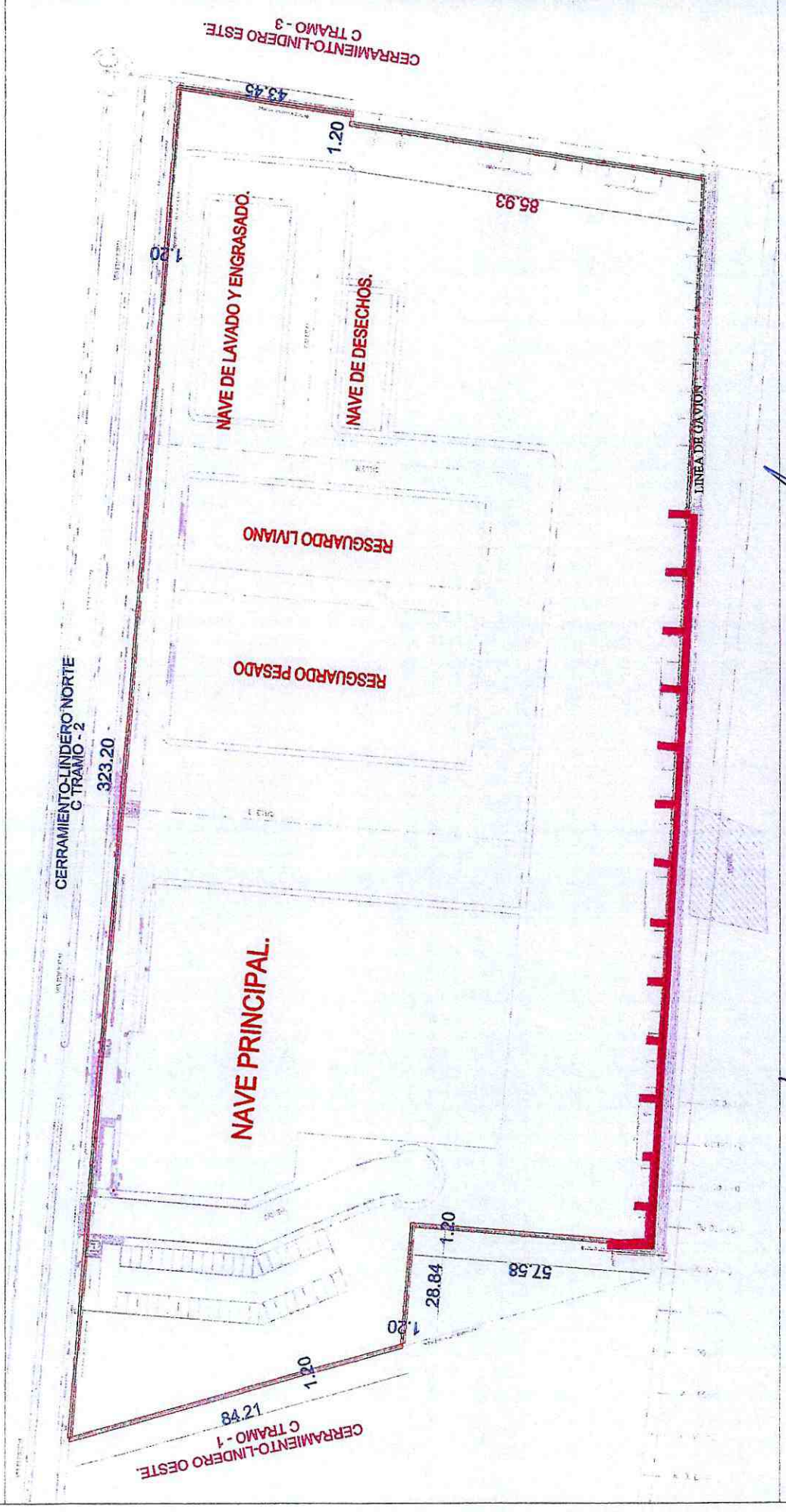

CERRAMIENTO OESTE TRAMO 1

CONTRATISTA

ESCALA

GOBIERNO AUTÓNOMO DESCENTRALIZADO DE LA
PROVINCIA DEL PASTAZA

" CONSTRUCCIÓN DE LOS HANGARES DEL GOBIERNO AUTÓNOMO DESCENTRALIZADO PROVINCIAL DE PASTAZA
(GADPPz) I ETAPA, PARROQUIA FÁTIMA, CANTÓN Y PROVINCIA DE PASTAZA "



PROYECTO:	ANEXO: 2
RUBRO	904
DESCRIPCION	DESALOJO MECANICO VOLQUETA TIERRA/ESCOBROS
UNIDAD	m3
PERIODO	1 DE JUNIO 2021 A 30 DE JUNIO 2021

CERRAMIENTO MALLA OESTE

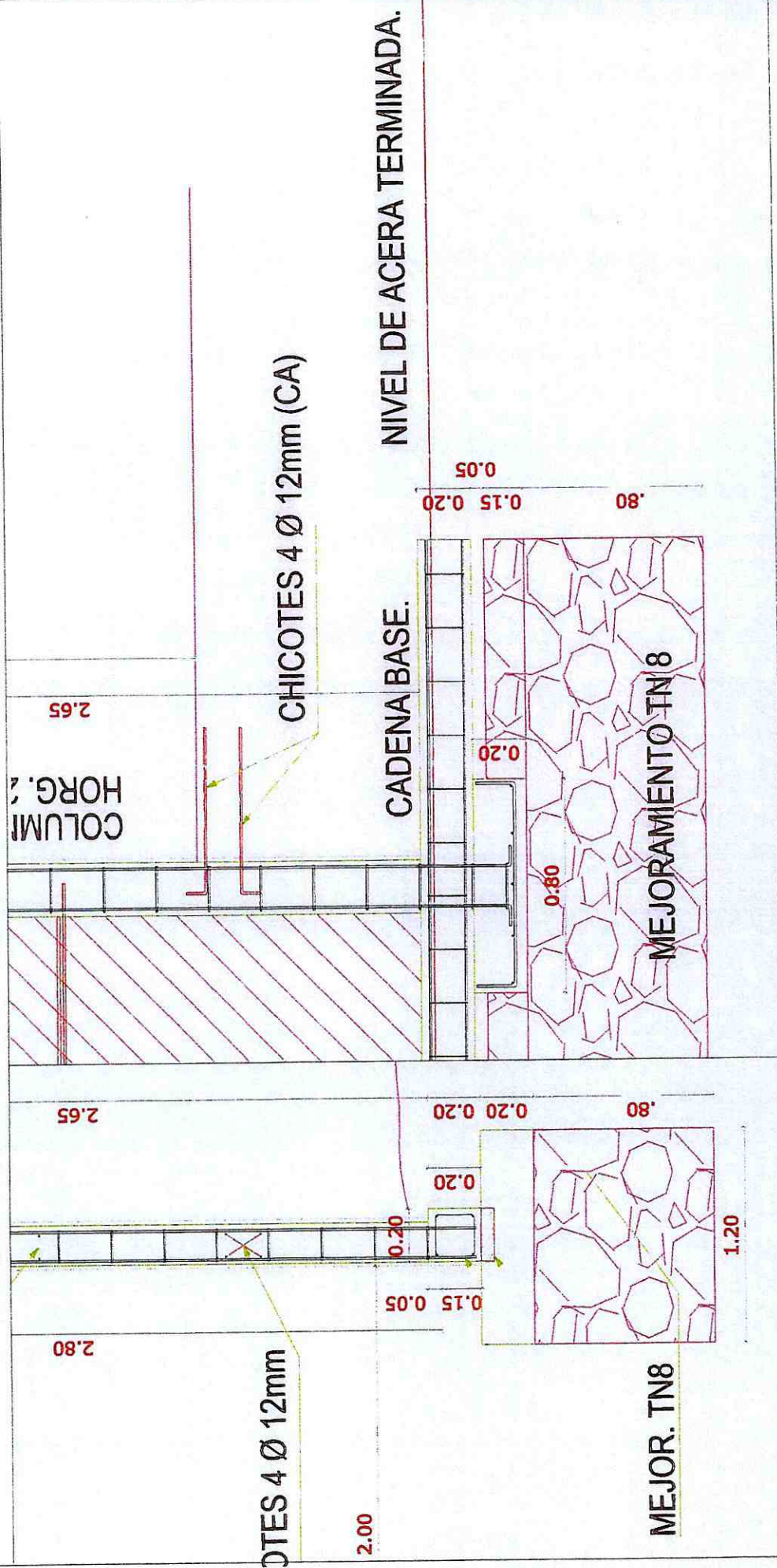

SECCION DE CORTE CERRAMIENTO

[Signature]
FISCALIZACION

[Signature]
CONTRATISTA

PROYECTO " CONSTRUCCIÓN DE LOS HANGARES DEL GOBIERNO AUTÓNOMO DESCENTRALIZADO PROVINCIAL DE PASTAZA (GADPPz) I ETAPA, PARROQUIA FÁTIMA, CANTÓN Y PROVINCIA DE PLANILLA DE AVANCE DE OBRA No. 23

RUBRO N° 905 ANEXO 1
 DESCRIPCIÓN: HORMIGON PREMEZCLADO REPLANTILLO F'C=180 KG/Cm2 INC. BOMBEO Y TRANSPORTE
 UNIDAD: m³
 PERIODO: 01-jun 30-jun



PAG. 1 DE 1

HORMIGON PREMEZCLADO REPLANTILLO F'C=180 KG/Cm2 INC. BOMBEO Y TRANSPORTE						
TRAMPAS DE GRASA DEL PROYECTO						
DESCRIPCION	LARGO (X)	ANCHO (Y)	ALTO (Z)	No.	SUBTOTAL	TOTAL
TRAMPA DE GRASA 1 MEC. LIVIANA						
TRAMPA DE GRASA 1	2,45	0,85	0,05	1,00	0,10	0,10
TRAMPA DE GRASA 2 MEC. PESADA						
TRAMPA DE GRASA 2	3,50	1,20	0,05	1,00	0,21	0,21
TRAMPA DE GRASA 1 MEC. LIVIANA - 3 LAVADO ENGRASADO						
TRAMPA DE GRASA 3	2,45	0,85	0,05	1,00	0,10	0,10
TRAMPA DE GRASA 4 MEC. PESADA						
TRAMPA DE GRASA 4	2,45	0,85	0,05	1,00	0,10	0,10
TOTAL						0,51

RESUMEN DE PLANILLA AL 100%					
DESCRIPCION	CONTRATADO	ANTERIOR	ACTUAL	ACUMULADO	UNIDAD
HORMIGON PREMEZCLADO REPLANTILLO F'C=180 KG/Cm2 INC. BOMBEO Y TRANSPORTE	9,34	8,23	0,51	8,74	m ³

 CONTRATISTA



 FISCALIZACIÓN



PROYECTO:

RUBRO	905	ANEXO: 1
DESCRIPCIÓN	HORMIGÓN PREMEZCLADO REPLANTILLO F' C=180 KG/Cm ² INC. BOMBEO Y TRANSPORTE	
UNIDAD	m ³	
PERIODO	1 DE JUNIO 2021 A 30 DE JUNIO 2021	

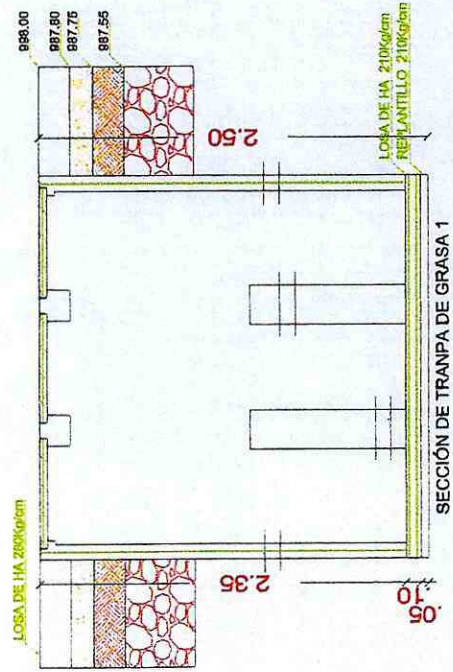
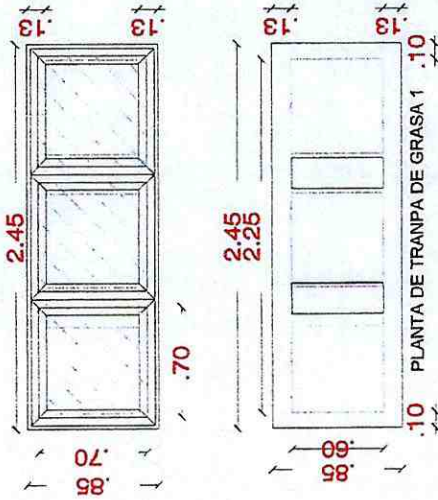
PLANTA DE TRANPA DE GRASA 1
MEC. LIVIANA



PLANTA DE TRANPA DE GRASA 2
MEC. PESADA

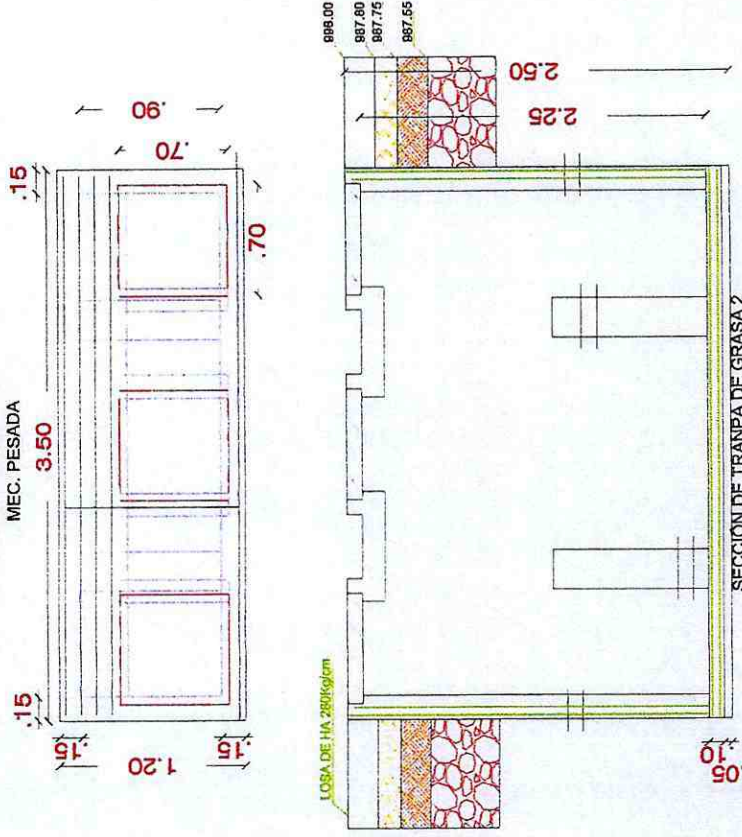

SECCIÓN DE TRANPA DE GRASA 2

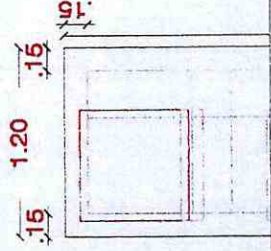

SECCIÓN DE TRANPA DE GRASA 2

CONTRATISTA

FISCALIZACIÓN

**GOBIERNO AUTÓNOMO DESCENTRALIZADO DE LA
PROVINCIA DEL PASTAZA**

" CONSTRUCCION DE LOS HANGARES DEL GOBIERNO AUTÓNOMO DESCENTRALIZADO PROVINCIAL DE PASTAZA
(GADPPz) I ETAPA, PARROQUIA FÁTIMA, CANTÓN Y PROVINCIA DE PASTAZA "



PROYECTO:

RUBRO	905	ANEXO: 2
DESCRIPCION	HORMIGON PREMEZCLADO REPLANTILLO F.C=180 KG/Cm2 INC. BOMBEO Y TRANSPORTE	
UNIDAD	m ²	
PERIODO	1 DE JUNIO 2021 A 30 DE JUNIO 2021	

PLANTA DE TRANPA DE GRASA 3
NAVE DE LAVADO ENGRASADO

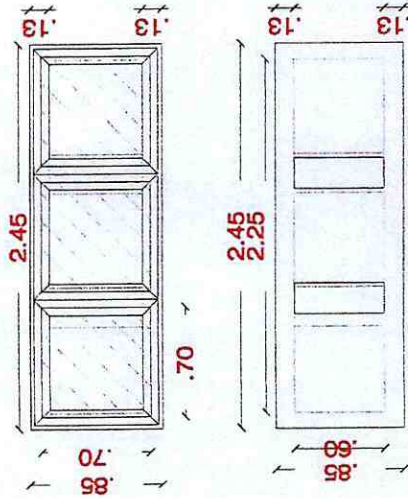

PLANTA DE TRANPA DE GRASA 1

PLANTA DE TRANPA DE GRASA 4
MAMPOSTERIA MEC. PESADA

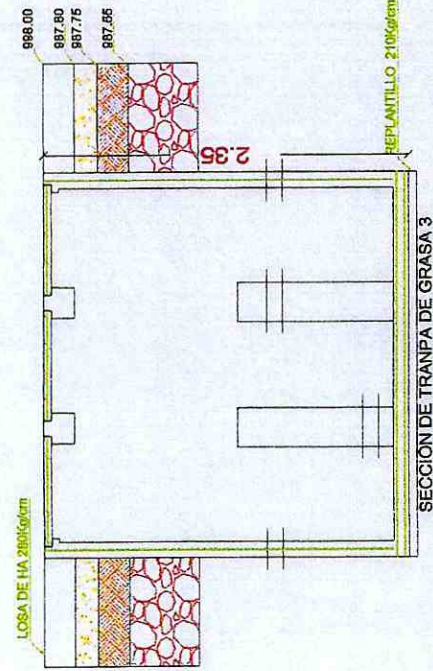
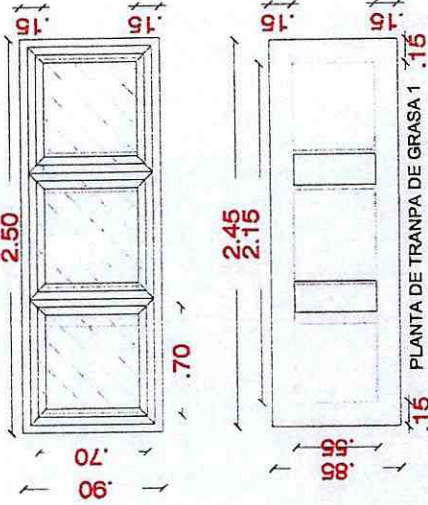

SECCION DE TRANPA DE GRASA 3

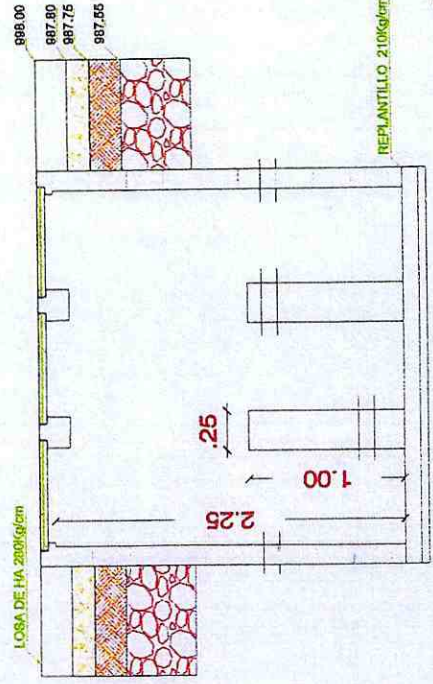

SECCION DE TRANPA DE GRASA 4

CONTRATISTA

FISCALIZACION

PROYECTO * CONSTRUCCIÓN DE LOS HANGARES DEL GOBIERNO AUTÓNOMO DESCENTRALIZADO PROVINCIAL DE PASTAZA (GADPPz) I ETAPA, PARROQUIA FÁTIMA, CANTÓN Y PROVINCIA DE PLANILLA DE AVANCE DE OBRA No. 23

RUBRO N° 907 ANEXO 1
 DESCRIPCIÓN: HORmIGON PREmEZCLADO CADENAS F'C=280 KG/Cm2 INC. ENCOFRADO INC. CONBEO Y TRANSPORTE
 UNIDAD: m3
 PERIODO: 01-jun 30-jun



HORmIGON PREmEZCLADO CADENAS F'C=280 KG/Cm2 INC. ENCOFRADO INC. CONBEO Y TRANSPORTE						
TRAMPAS DE GRASA DEL PROYECTO						
DESCRIPCION	LARGO (X)	ANCHO (Y)	ALTO (Z)	No.	SUBTOTAL	TOTAL
TRAMPA DE GRASA 1 MEC. LIVIANA						
TRAMPA DE GRASA 1	2,45	0,85	0,10	2,00	0,42	0,42
TRAMPA DE GRASA 2 MEC. PESADA						
TRAMPA DE GRASA 2	3,50	1,20	0,10	2,00	0,84	0,84
TRAMPA DE GRASA 1 MEC. LIVIANA - 3 LAVADO ENGRASADO						
TRAMPA DE GRASA 3	2,45	0,85	0,10	2,00	0,42	0,42
TRAMPA DE GRASA 4 MEC. PESADA						
TRAMPA DE GRASA 4	2,45	0,85	0,10	2,00	0,42	0,42
					TOTAL	2,10

HORmIGON PREmEZCLADO CADENAS F'C=280 KG/Cm2 INC. ENCOFRADO INC. CONBEO Y TRANSPORTE						
BASES PARA GENERADORES INTERNOS Y EXTERNOS						
DESCRIPCION	LARGO (X)	ANCHO (Y)	ALTO (Z)	No.	SUBTOTAL	TOTAL
BASE PARA GENERADORES ADM PB						
BASE 1	1,65	1,30	0,20	2,00	0,86	0,86
DESCUENTO	1,25	0,50	0,20	-1,00	-0,13	-0,13
BASES PARA CUARTO ELECTROGENO ADM PB						
BASE 2	3,25	1,30	0,20	2,00	1,69	1,69
BASE PARA GENERADORES EXTERIOR VIA C						
BASE 3	1,65	1,30	0,20	2,00	0,86	0,86
DESCUENTO	1,25	0,50	0,20	-1,00	-0,13	-0,13
BASE PARA GENERADORES LAVADO ENGRASADO						
BASE 4	1,65	1,30	0,20	2,00	0,86	0,86
DESCUENTO	1,25	0,50	0,20	-1,00	-0,13	-0,13
					TOTAL 2	3,88

RESUMEN DE PLANILLA AL 100%					
DESCRIPCION	CONTRATADO	ANTERIOR	ACTUAL	ACUMULADO	UNIDAD
HORmIGON PREmEZCLADO CADENAS F'C=280 KG/Cm2 INC. ENCOFRADO INC. CONBEO Y TRANSPORTE	30,84	19,61	5,98	25,59	m3

 CONTRATISTA



 FISCALIZACIÓN

RUBRO 907
DESCRIPCIÓN HORMIGÓN PREMEZCLADO CADENAS F'c=280 KG/Cm² INC. ENCOFRADO INC. CONBEO Y TRANSPORTE
UNIDAD m³
PERIODO 1 DE JUNIO 2021 A 30 DE JUNIO 2021

ANEXO: 1

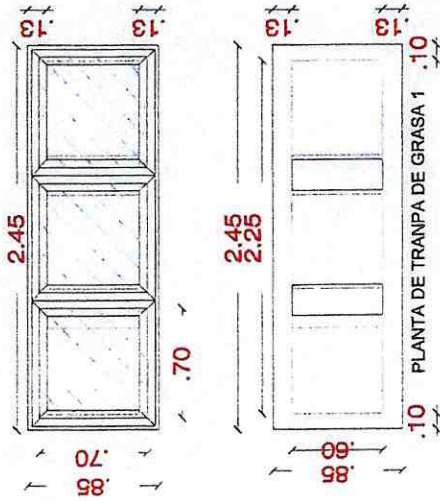

PLANTA DE TRANPA DE GRASA 1
MEC. LIVIANA



PLANTA DE TRANPA DE GRASA 2
MEC. PESADA

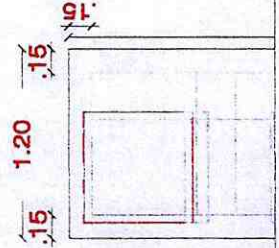
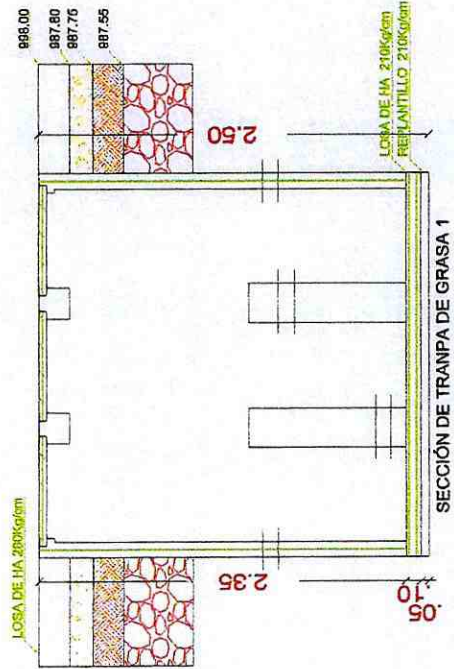
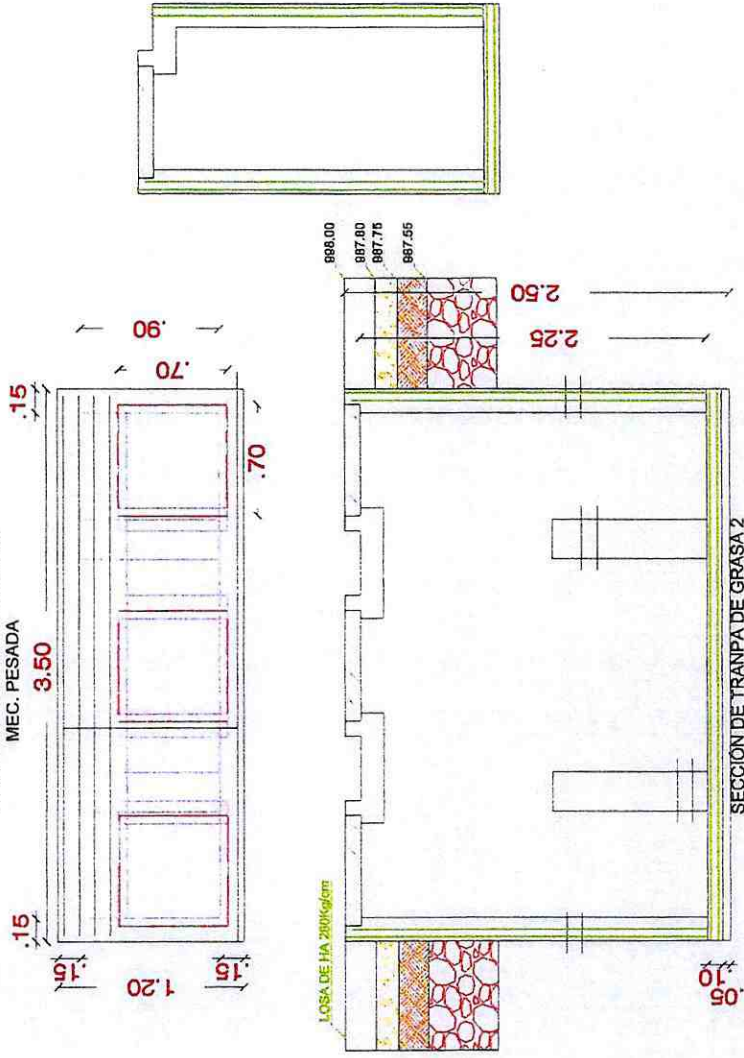



PROYECTO:	ANEXO: 2		
RUBRO	907	HORMIGÓN PREMEZCLADO CADENAS FC=280 KG/CM ² INC. ENCOFRADO INC. CONBEO Y TRANSPORTE	
DESCRIPCIÓN	m ³		
UNIDAD			
PERIODO	1 DE JUNIO 2021 A 30 DE JUNIO 2021		

PLANTA DE TRANPA DE GRASA 3
NAVE DE LAVADO ENGRASADO

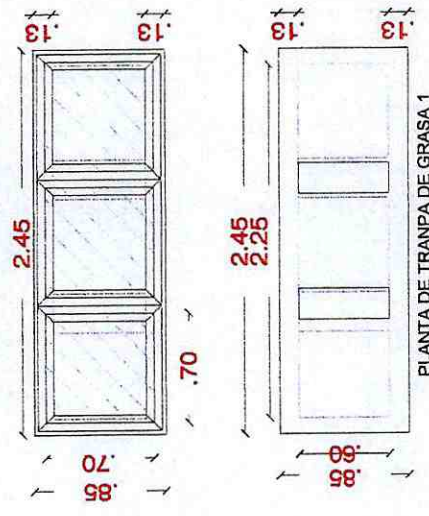

PLANTA DE TRANPA DE GRASA 4
MAMPOSTERÍA MEC. PESADA

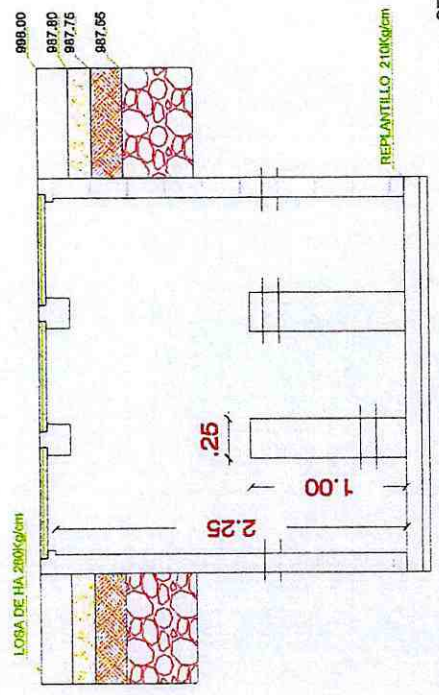
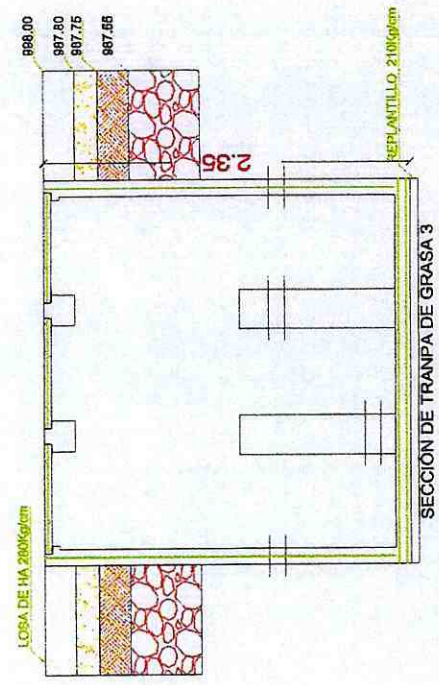
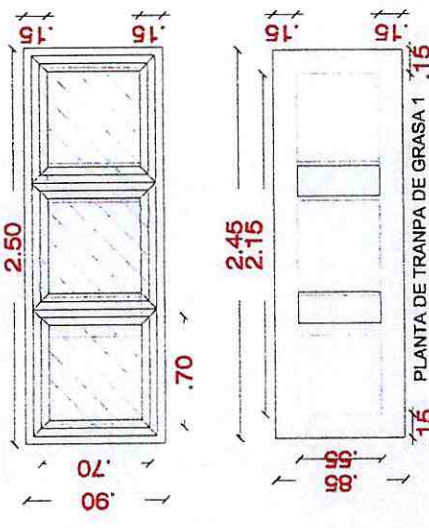

SECCIÓN DE TRANPA DE GRASA 3

SECCIÓN DE TRANPA DE GRASA 4

CONTRATISTA

FISCALIZACIÓN

UBICACION - GARITA # 1

**GOBIERNO AUTONOMO DESCENTRALIZADO DE LA
PROVINCIA DEL PASTAZA**

" CONSTRUCCIÓN DE LOS HANGARES DEL GOBIERNO AUTÓNOMO DESCENTRALIZADO PROVINCIAL DE PASTAZA
(GADPPz) I ETAPA, PARROQUIA FÁTIMA, CANTÓN Y PROVINCIA DE PASTAZA "



ANEXO: 3

RUBRO	907
DESCRIPCION	HORMIGON PREMEZCLADO CADENAS F'C=280 KG/Cm2 INC. ENCOFRADO INC. CONBEO Y TRANSPORTE
UNIDAD	m3
PERIODO	1 DE JUNIO 2021 A 30 DE JUNIO 2021

PROYECTO:

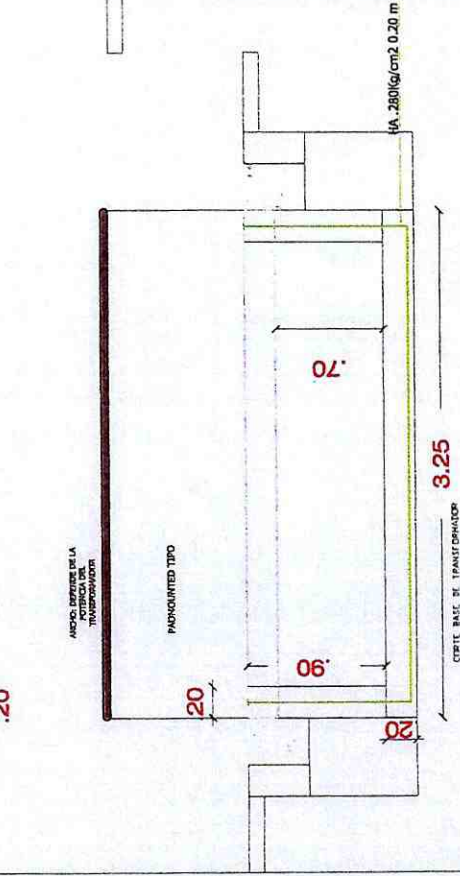
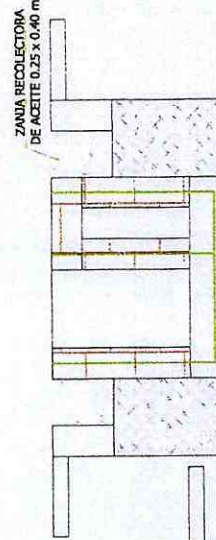
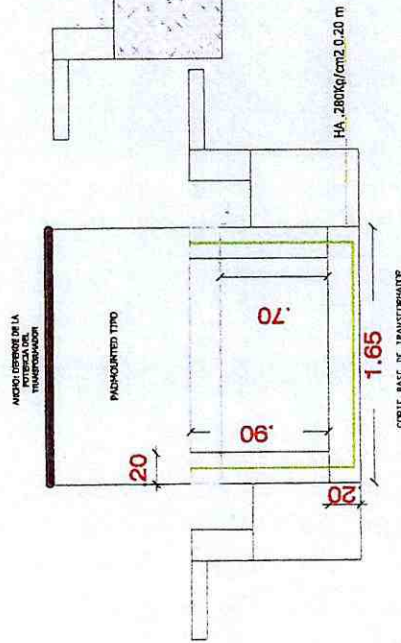
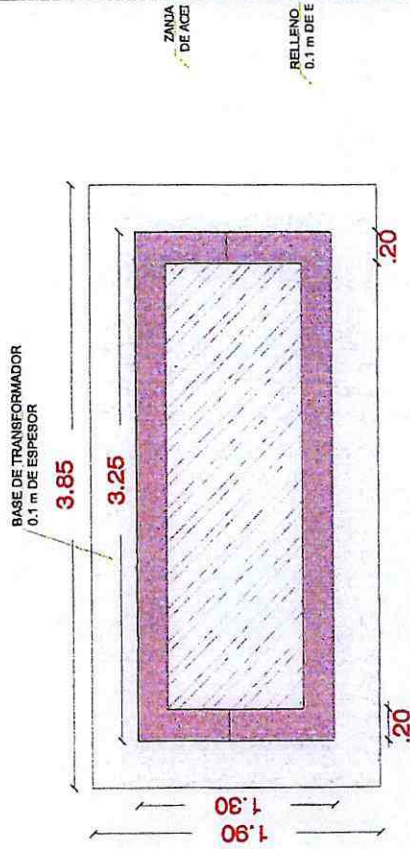
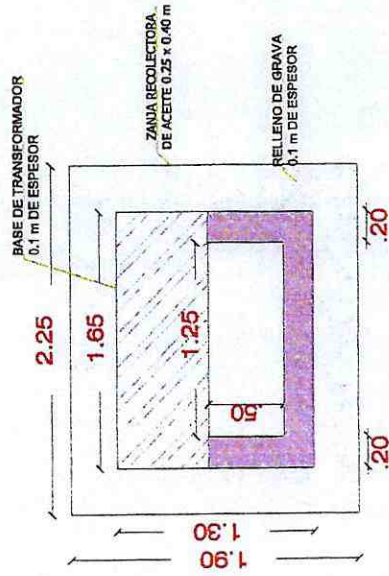

UBICACION - GARITA #1

CONTRATISTA

FISCALIZACIÓN

PROYECTO "CONSTRUCCIÓN DE LOS HANGARES DEL GOBIERNO AUTÓNOMO DESCENTRALIZADO PROVINCIAL DE PASTAZA (GADPPz) I ETAPA, PARROQUIA FÁTIMA, CANTÓN Y PROVINCIA DE PLANILLA DE AVANCE DE OBRA No. 23

RUBRO N° 908 ANEXO 1
 DESCRIPCIÓN: HORMIGON PREMEZCLADO COLUMNAS F'C=280 KG/Cm2 INC. ENCOFRADO, BOMBA Y TRANSPORTE
 UNIDAD: m3
 PERIODO: 01-jun 30-jun



HORMIGON PREMEZCLADO COLUMNAS F'C=280 KG/Cm2 INC. ENCOFRADO, BOMBA Y TRANSPORTE						
TRAMPAS DE GRASA DEL PROYECTO						
DESCRIPCION	LARGO (X)	ANCHO (Y)	ALTO (Z)	No.	SUBTOTAL	TOTAL
TRAMPA DE GRASA 1 MEC. LIVIANA						
TRAMPA DE GRASA PARED 1	0,85	0,10	2,25	2,00	0,38	0,38
TRAMPA DE GRASA PARED 2	2,45	0,13	2,25	2,00	1,43	1,43
ANTEPECHO PARED 1-2	0,55	0,25	1,00	2,00	0,28	0,28
TRAMPA DE GRASA 2 MEC. PESADA						
TRAMPA DE GRASA PARED 1	1,20	0,15	2,25	2,00	0,81	0,81
TRAMPA DE GRASA PARED 2	3,50	0,15	2,25	2,00	2,36	2,36
ANTEPECHO PARED 1-2	0,90	0,25	1,00	2,00	0,45	0,45
TRAMPA DE GRASA 1 MEC. LIVIANA - 3 LAVADO ENGRASADO						
TRAMPA DE GRASA PARED 1	0,85	0,10	2,25	2,00	0,38	0,38
TRAMPA DE GRASA PARED 2	2,45	0,13	2,25	2,00	1,43	1,43
ANTEPECHO PARED 1-2	0,55	0,25	1,00	2,00	0,28	0,28
					TOTAL	7,80

HORMIGON PREMEZCLADO COLUMNAS F'C=280 KG/Cm2 INC. ENCOFRADO, BOMBA Y TRANSPORTE						
BASES PARA GENERADORES INTERNOS Y EXTERNOS						
DESCRIPCION	LARGO (X)	ANCHO (Y)	ALTO (Z)	No.	SUBTOTAL	TOTAL
BASE PARA GENERADORES ADM PB						
PARED 1	1,30	0,20	0,70	2,00	0,36	0,36
PARED 2	1,65	0,20	0,70	3,00	0,69	0,69
BASES PARA CUARTO ELECTROGENO ADM PB						
PARED 1	1,30	0,20	0,70	2,00	0,36	0,36
PARED 2	1,65	0,20	0,70	2,00	0,46	0,46
BASE PARA GENERADORES EXTERIOR VIA C						
PARED 1	1,30	0,20	0,70	2,00	0,36	0,36
PARED 2	1,65	0,20	0,70	3,00	0,69	0,69
BASE PARA GENERADORES LAVADO ENGRASADO						
PARED 1	1,30	0,20	0,70	2,00	0,36	0,36
PARED 2	1,65	0,20	0,70	3,00	0,69	0,69
					TOTAL 2	3,97

RESUMEN DE PLANILLA AL 100%					
DESCRIPCION	CONTRATADO	ANTERIOR	ACTUAL	ACUMULADO	UNIDAD
HORMIGON PREMEZCLADO COLUMNAS F'C=280 KG/Cm2 INC. ENCOFRADO, BOMBA Y TRANSPORTE	89,64	13,76	11,77	25,53	m3

CONTRATISTA

FISCALIZACIÓN

BIERNO AUTONOMO DESCENTRALIZADO DE
PROVINCIA DEL PASTAZA

" CONSTRUCCIÓN DE LOS HANGARES DEL GOBIERNO AUTÓNOMO DESCENTRALIZADO PROVINCIAL DE PASTAZA
(GADPPz) I ETAPA, PARROQUIA FÁTIMA, CANTÓN Y PROVINCIA DE PASTAZA "



PROYECTO:	ANEXO: 1
RUBRO	908
DESCRIPCION	HORMIGÓN PREMEZCLADO COLUMNAS F'C=280 KG/Cm2 INC. ENCOFRADO. BOMBA Y TRANSPORTE
UNIDAD	m3
PERIODO	1 DE JUNIO 2021 A 30 DE JUNIO 2021

PLANTA DE TRANPA DE GRASA 1
MEC. LIVIANA

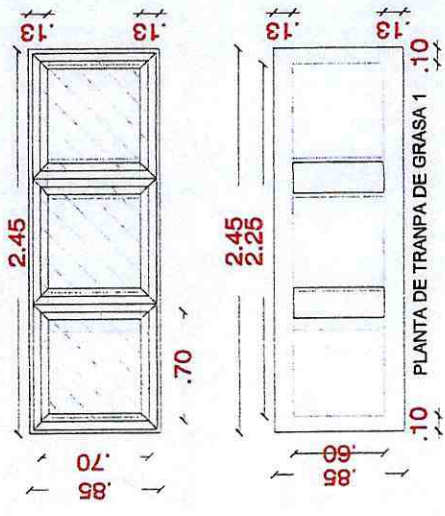

PLANTA DE TRANPA DE GRASA 2
MEC. PESADA

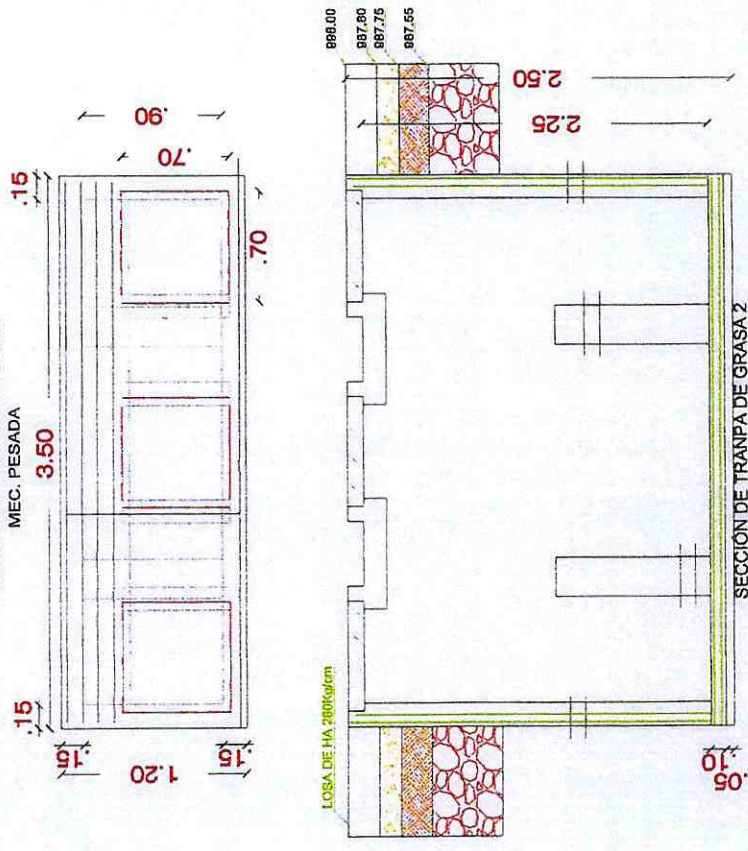

PLANTA DE TRANPA DE GRASA 1
MEC. PESADA

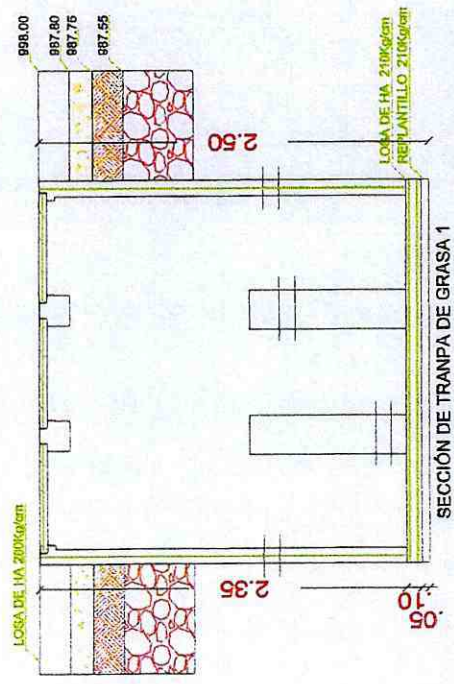

SECCION DE TRANPA DE GRASA 2

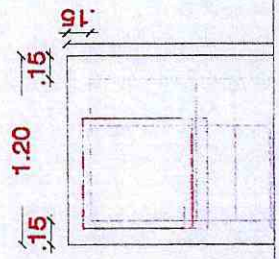

SECCION DE TRANPA DE GRASA 1

CONTRATISTA

UBICACION - GARITA # 1

FISCALIZACION

" CONSTRUCCIÓN DE LOS HANGARES DEL GOBIERNO AUTÓNOMO DESCENTRALIZADO PROVINCIAL DE PASTAZA
(GADPPz) I ETAPA, PARROQUIA FÁTIMA, CANTÓN Y PROVINCIA DE PASTAZA "

PROYECTO:

RUBRO	908
DESCRIPCION	HORMIGON PREMEZCLADO COLUMNAS F/C=280 KG/Cm2 INC. ENCOFRADO, BOMBA Y TRANSPORTE
UNIDAD	m3
PERIODO	1 DE JUNIO 2021 A 30 DE JUNIO 2021

ANEXO: 2

PLANTA DE TRANPA DE GRASA 3
NAVE DE LAVADO ENGRASADO

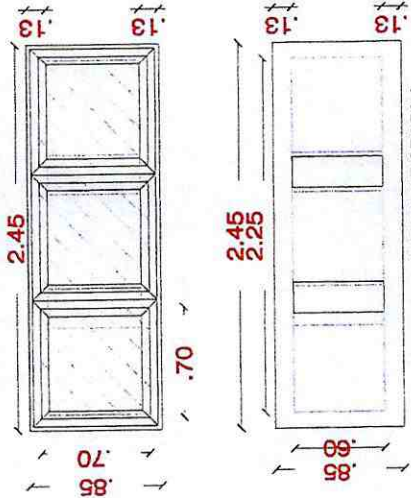

PLANTA DE TRANPA DE GRASA 1

PLANTA DE TRANPA DE GRASA 4
MAMPOSTERIA MEC. PESADA

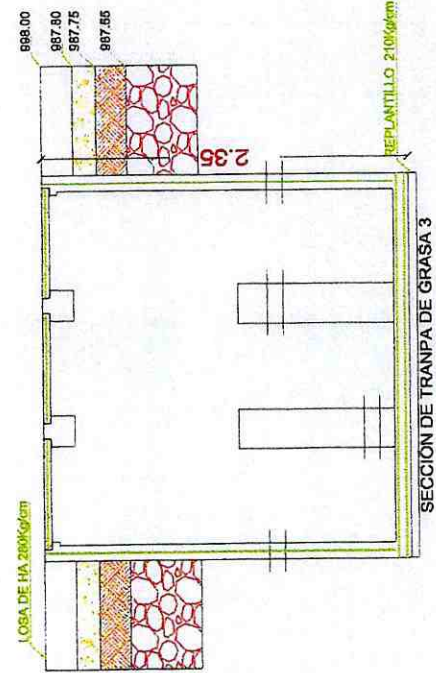
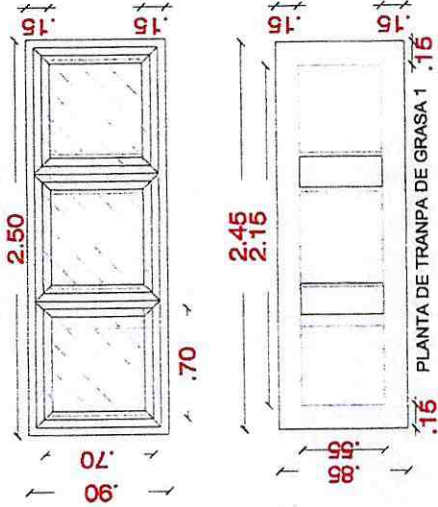

SECCION DE TRANPA DE GRASA 3

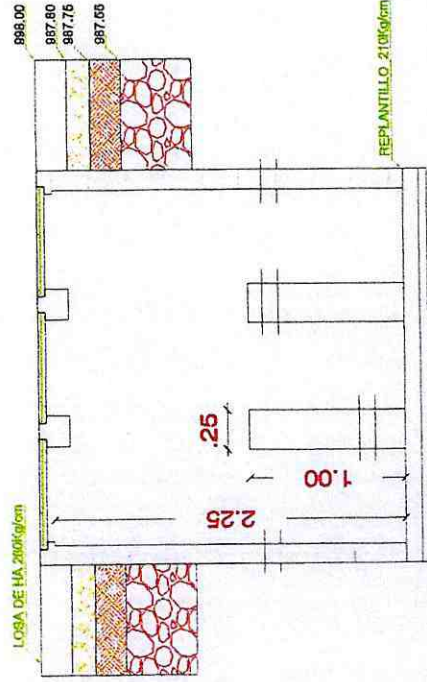

SECCION DE TRANPA DE GRASA 1

UBICACION - GARITA # 1

CONTRATISTA

FISCALIZACION

"CONSTRUCCIÓN DE LOS HANGARES DEL GOBIERNO AUTÓNOMO DESCENTRALIZADO PROVINCIAL DE PASTAZA
(GADPPz) I ETAPA, PARROQUIA FÁTIMA, CANTÓN Y PROVINCIA DE PASTAZA "

PROYECTO:	ANEXO: 3		
RUBRO	908	HORMIGÓN PREMEZCLADO COLUMNAS F'C=280 KG/Cm ² INC. ENCOFRADO, BOMBA Y TRANSPORTE	
DESCRIPCIÓN	m ³		
UNIDAD	1 DE JUNIO 2021 A 30 DE JUNIO 2021		
PERIODO			

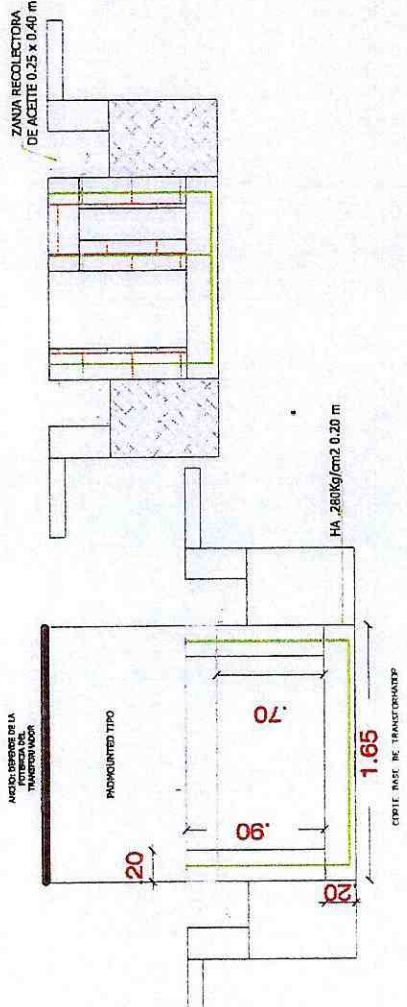
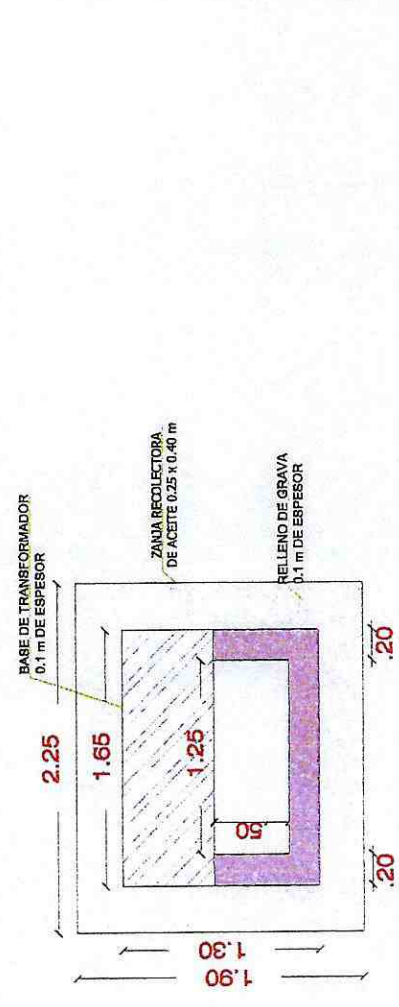
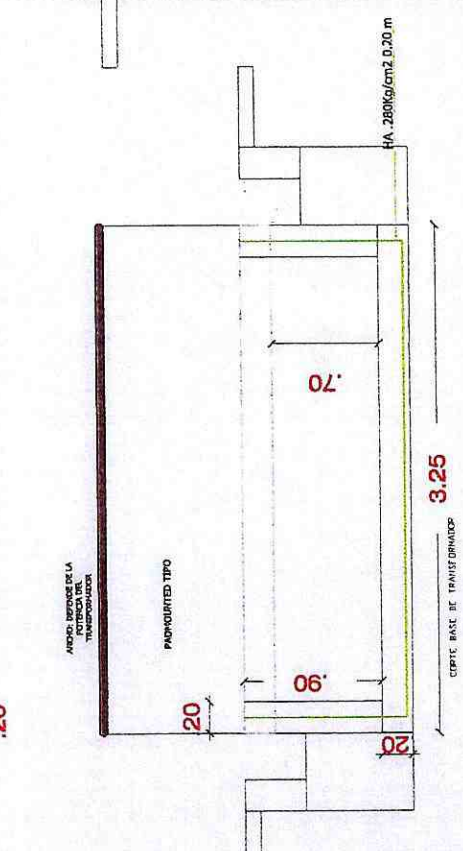
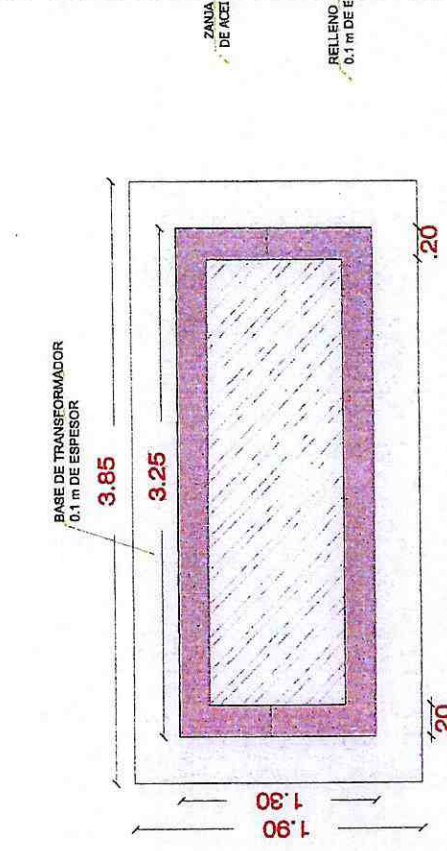

UBICACION - GARITA # 1

CONTRATISTA

FISCALIZACIÓN

GOBIERNO AUTÓNOMO DESCENTRALIZADO DE LA PROVINCIA DEL PASTAZA

PROYECTO * CONSTRUCCIÓN DE LOS HANGARES DEL GOBIERNO AUTÓNOMO DESCENTRALIZADO PROVINCIAL DE PASTAZA (GADPPz) I ETAPA, PARROQUIA FÁTIMA, CANTÓN Y PROVINCIA DE PLANILLA DE AVANCE DE OBRA No. 23

RUBRO N° 909 ANEXO 1
 DESCRIPCIÓN: HORMIGÓN CICLÓPEO (50por ciento H.S. F'C=180 KG/Cm2-50por cientoP)CIm
 UNIDAD: m3
 PERIODO: 01-jun 30-jun



1 DE 1

HORMIGÓN CICLÓPEO (50por ciento H.S. F'C=180 KG/Cm2-50por cientoP)CIm						
CADENAS DE HORMIGON EN CERRAMIENTO DE PTAR						
DESCRIPCION	LARGO (X)	ANCHO (Y)	ALTO (Z)	No.	SUBTOTAL	TOTAL
TRAMO 1	6,36	0,30	0,40	1,00	0,76	0,76
TRAMO 2	3,41	0,30	0,60	1,00	0,61	0,61
TRAMO 3	3,81	0,30	0,90	1,00	1,03	1,03
TRAMO 4	9,44	0,30	0,4	1,00	1,13	1,13
TRAMO 5	3,00	0,30	0,4	1,00	0,36	0,36
TRAMO 6	3,00	0,30	0,4	1,00	0,36	0,36
TRAMO 7	2,98	0,30	0,4	1,00	0,36	0,36
TRAMO 8	7,00	0,30	0,4	1,00	0,84	0,84
TRAMO 9	6,58	0,30	0,4	1,00	0,79	0,79
TOTAL					6,24	6,24

RESUMEN DE PLANILLA DE INCREMENTOS						
DESCRIPCION	CONTRATADO	ANTERIOR	ACTUAL	INCR. ANT.	INCR. ACT.	UNIDAD
HORMIGÓN CICLÓPEO (50por ciento H.S. F'C=180 KG/Cm2-50por cientoP)CIm	43,60	90,41			6,24	m3

CONTRATISTA

FISCALIZACIÓN

**GOBIERNO AUTONOMO DESCENTRALIZADO DE LA
PROVINCIA DEL PASTAZA**

" CONSTRUCCIÓN DE LOS HANGARES DEL GOBIERNO AUTÓNOMO DESCENTRALIZADO PROVINCIAL DE PASTAZA
(GADPPz) I ETAPA, PARROQUIA FÁTIMA, CANTÓN Y PROVINCIA DE PASTAZA "



ANEXO: 1

RUBRO	909
DESCRIPCION	HORMIGÓN CICLÓPEO (50 por ciento H.S. F' C=180 KG/Cm ² -50 por ciento P)C/m
UNIDAD	m ³
PERIODO	1 DE JUNIO 2021 A 30 DE JUNIO 2021

CERRAMIENTO MALLA PTAR



CERRAMIENTO DE PTAR

CONTRATISTA

FIRMA/SEALIZACIÓN

**GOBIERNO AUTÓNOMO DESCENTRALIZADO DE LA
PROVINCIA DEL PASTAZA**

" CONSTRUCCIÓN DE LOS HANGARES DEL GOBIERNO AUTÓNOMO DESCENTRALIZADO PROVINCIAL DE PASTAZA
(GADPPz) I ETAPA, PARROQUIA FÁTIMA, CANTÓN Y PROVINCIA DE PASTAZA "

ANEXO: 2

RUBRO	909
DESCRIPCION	HORMIGÓN CICLÓPEO (50por ciento H.S. F' C=180 KG/Cm ² -50por cientoP/C)Im
UNIDAD	m ³
PERIODO	1 DE JUNIO 2021 A 30 DE JUNIO 2021

CERRAMIENTO MALLA PTAR

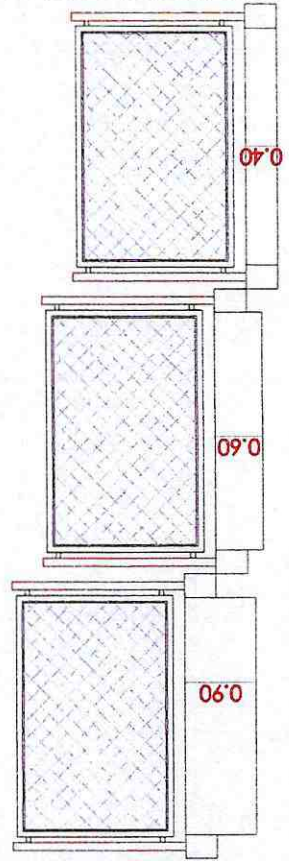
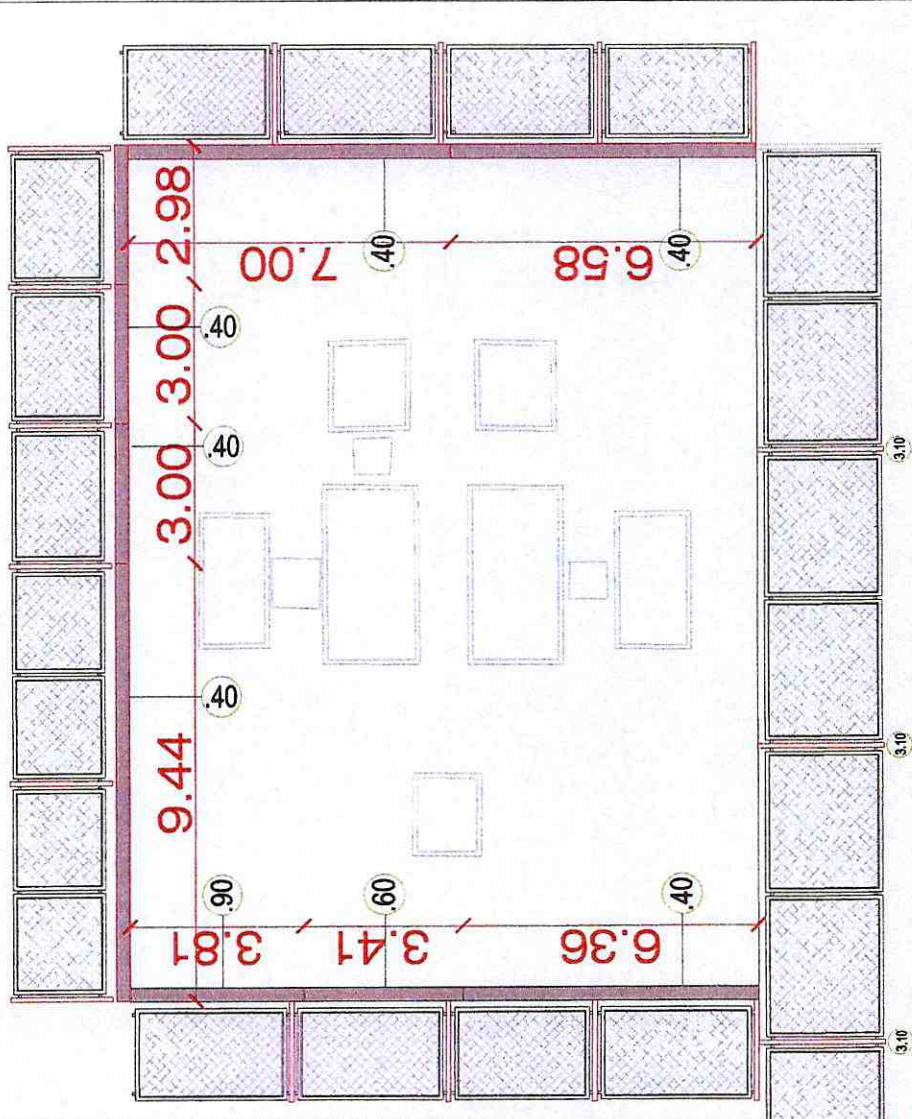

[Signature]
CONTRATISTA

[Signature]
FISCALIZACIÓN

PROYECTO: " CONSTRUCCIÓN DE LOS HANGARES DEL GOBIERNO AUTÓNOMO DESCENTRALIZADO PROVINCIAL DE PASTAZA (GADPPz) | ETAPA, PARROQUIA FÁTIMA, CANTÓN Y PROVINCIA DE PASTAZA "



RUBRO	910	ANEXO: 1
DESCRIPCION	ACERO DE REFUERZO F'Y= 4200 Kg/Cm2	
UNIDAD	Kg	
PERIODO	1 DE JUNIO 2021 A 30 DE JUNIO 2021	

DUCTO DE L ASCENSC

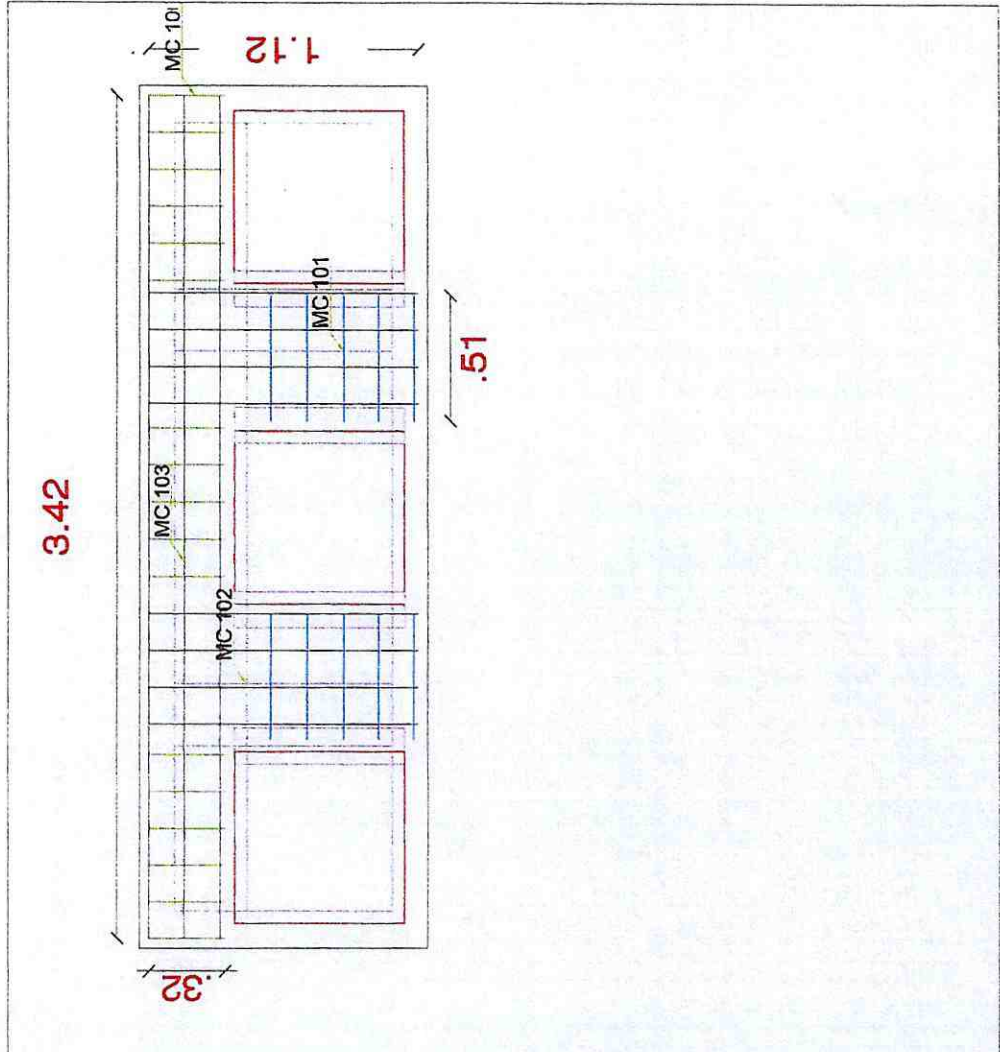
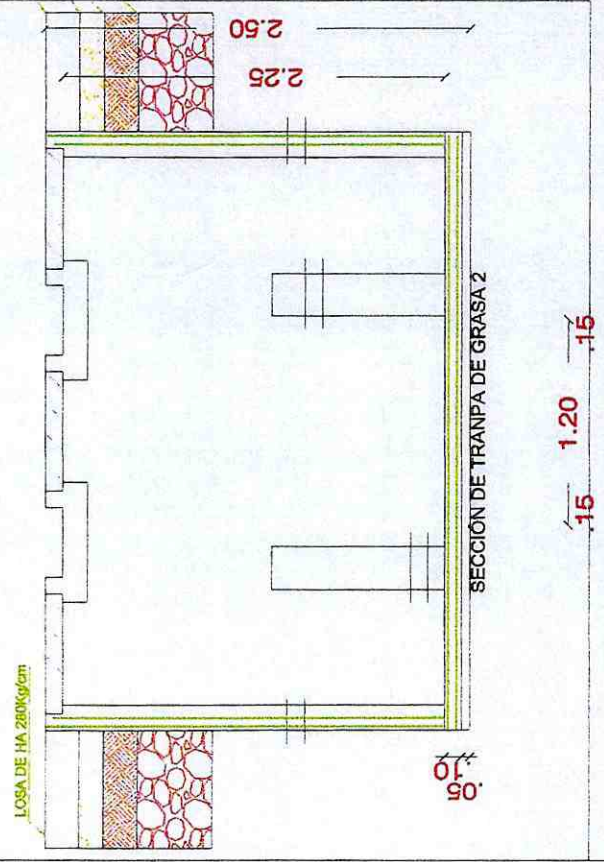
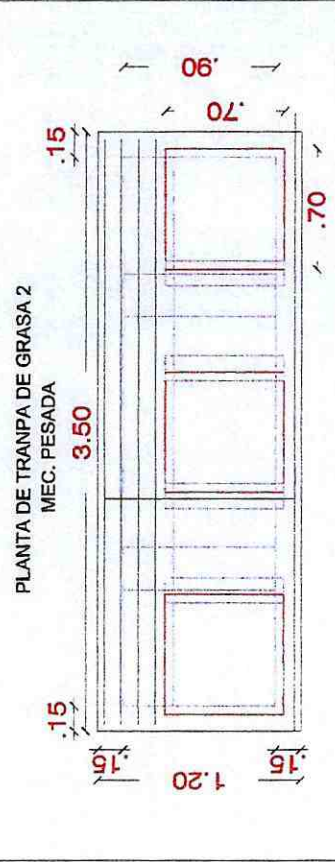

LOCALIZACIÓN

UBICACION - GARITA # 1

CONTRATISTA

**BIENIO AUTÓNOMO DESCENTRALIZADO DE
PROVINCIA DEL PASTAZA**

" CONSTRUCCIÓN DE LOS HANGARES DEL GOBIERNO AUTÓNOMO DESCENTRALIZADO PROVINCIAL DE PASTAZA
(GADPPz) I ETAPA, PARROQUIA FÁTIMA, CANTÓN Y PROVINCIA DE PASTAZA "



PROYECTO:	911	ANEXO: 1
RUBRO	PERFIL ESTRUCTURAL ACERO ASTM A (36, 572, 325, 193, 108) (PROY. MONTAJE GRUA)	
DESCRIPCION		
UNIDAD	Kg	
PERIODO	1 DE JUNIO 2021 A 30 DE JUNIO 2021	

CERRAMIENTO MALLA PTAR

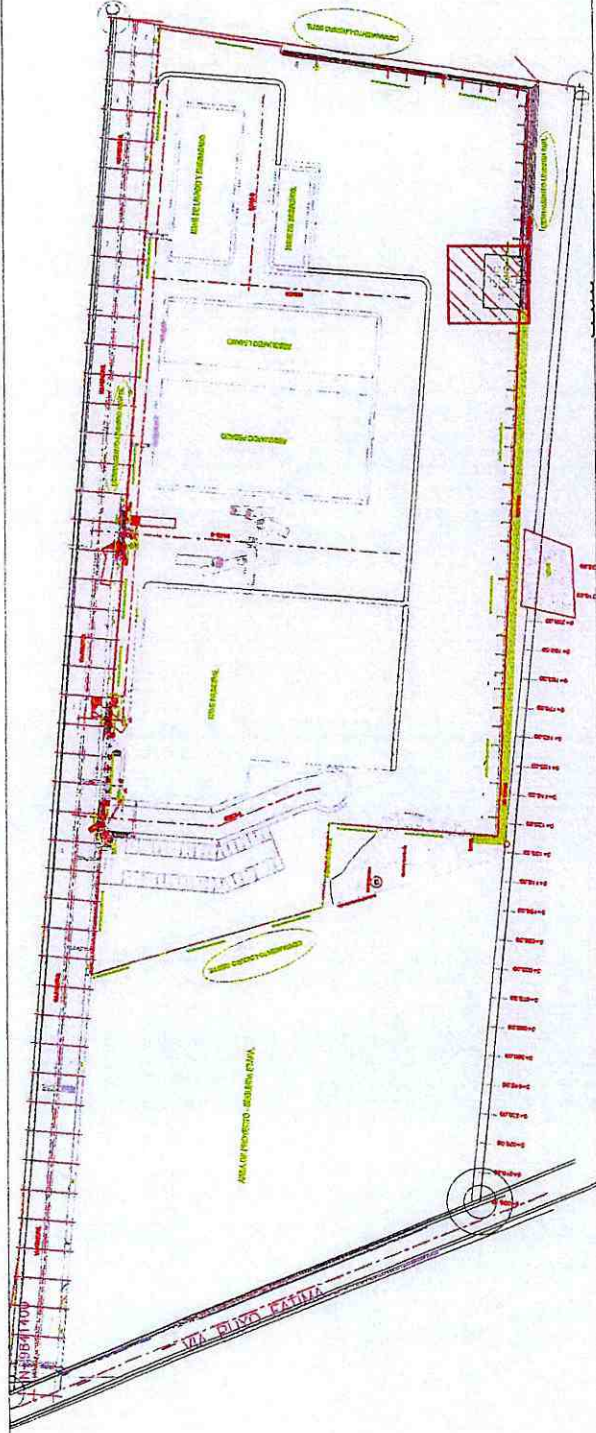

CERRAMIENTO DE PTAR

CONTRATISTA

FISCALIZACIÓN

GOBIERNO AUTÓNOMO DESCENTRALIZADO DE LA PROVINCIA DEL PASTAZA

" CONSTRUCCIÓN DE LOS HANGARES DEL GOBIERNO AUTÓNOMO DESCENTRALIZADO PROVINCIAL DE PASTAZA (GADPPz) | ETAPA, PARROQUIA FÁTIMA, CANTÓN Y PROVINCIA DE PASTAZA "

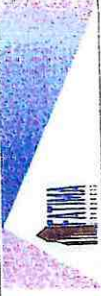

ANEXO: 2

911 PERFIL ESTRUCTURAL ACERO ASTM A (36, 572, 325, 193, 108) (PROY. MONTAJE GRUA)

UNIDAD Kg

PERIODO 1 DE JUNIO 2021 A 30 DE JUNIO 2021

CERRAMIENTO MALLA PTAR

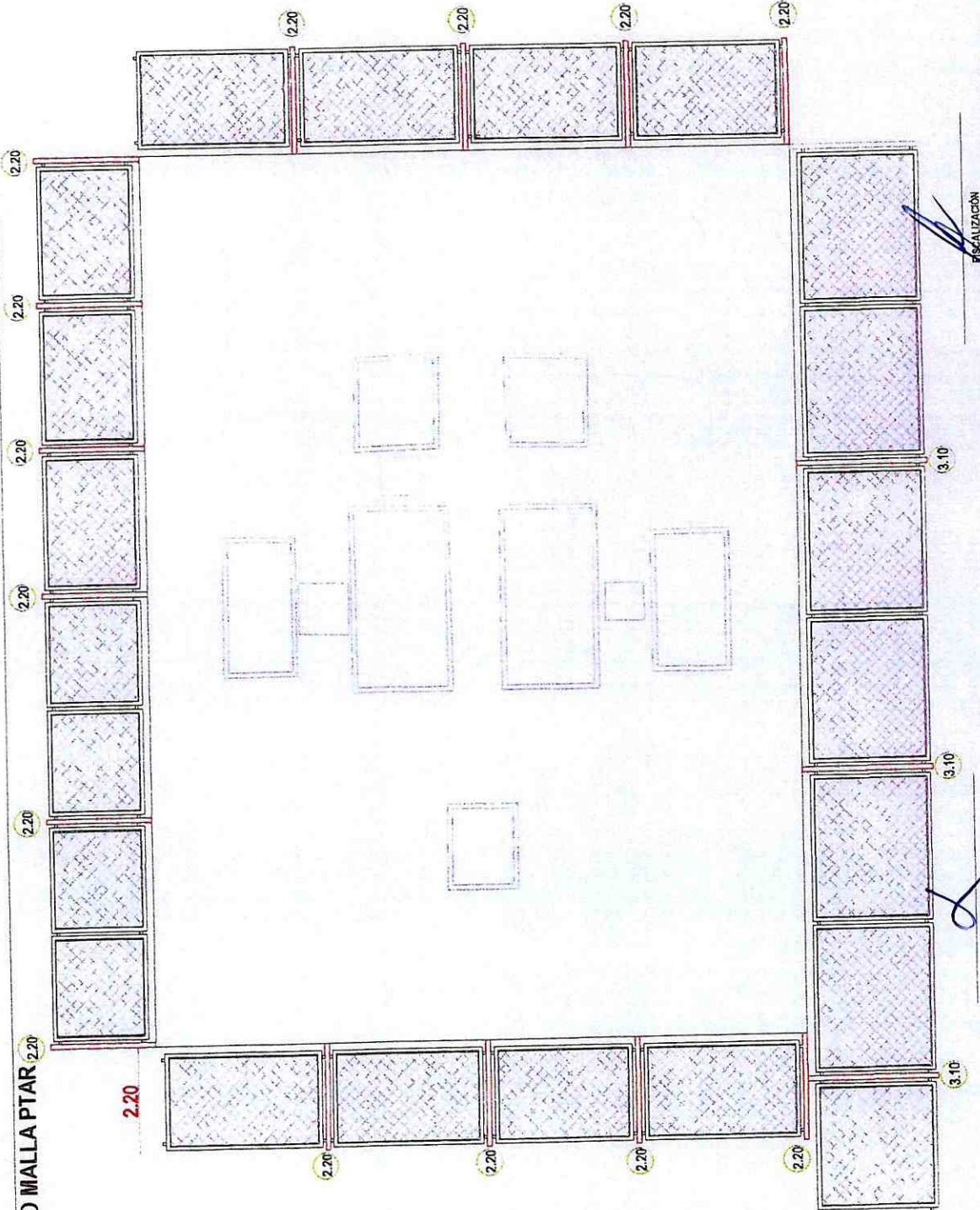

FISCALIZACIÓN

CONTRATISTA

BIERNO AUTONOMO DESCENTRALIZADO DE
PROVINCIA DEL PASTAZA

" CONSTRUCCIÓN DE LOS HANGARES DEL GOBIERNO AUTONOMO DESCENTRALIZADO PROVINCIAL DE PASTAZA
(GADPPz) I ETAPA, PARROQUIA FÁTIMA, CANTÓN Y PROVINCIA DE PASTAZA "



PROYECTO:

RUBRO	912
DESCRIPCION	TRATAMIENTO PINTURA ESTRUCTURA ACERO A36 (FONDO+PINTURA ANTICORROSIVA), A COMPRESOR
UNIDAD	Kg
PERIODO	1 DE JUNIO 2021 A 30 DE JUNIO 2021

ANEXO: 1

CERRAMIENTO MALLA PTAR

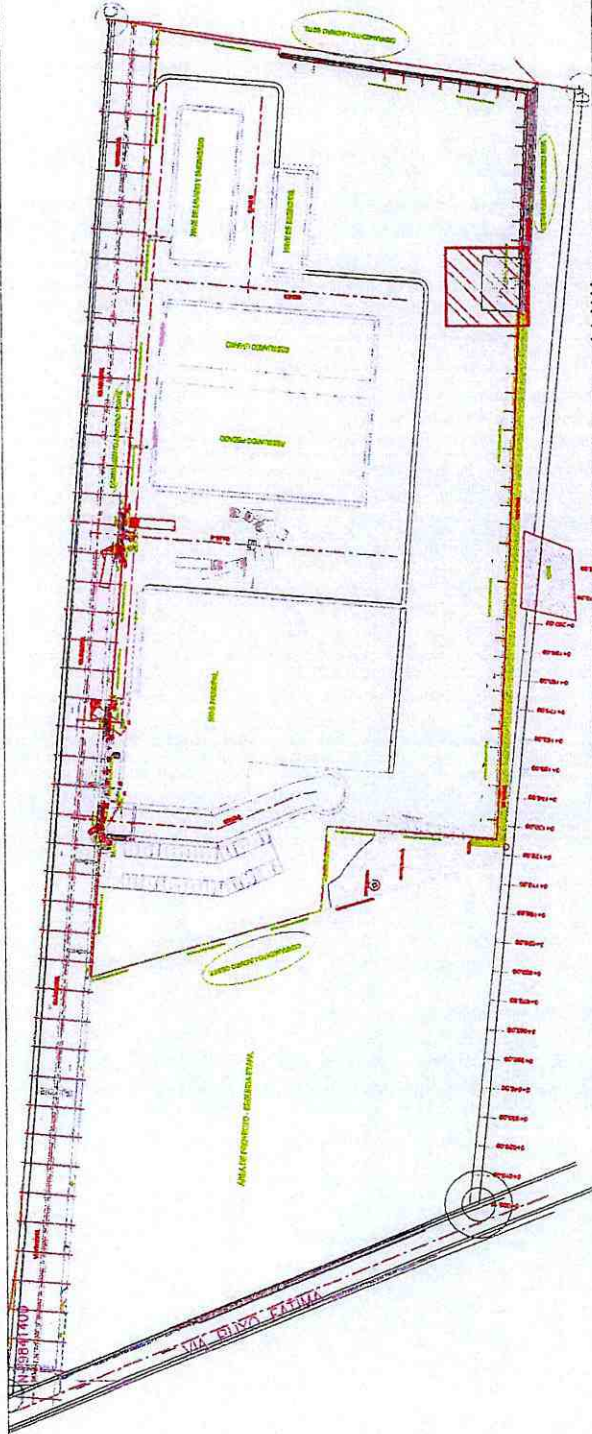

CERRAMIENTO DE PTAR

[Signature]
CONTRATISTA

[Signature]
FISCALIZACIÓN

BIERNO AUTONOMO DESCENTRALIZADO DE
 PROVINCIA DEL PASTAZA

" CONSTRUCCIÓN DE LOS HANGARES DEL GOBIERNO AUTONOMO DESCENTRALIZADO PROVINCIAL DE PASTAZA
 (GADPPz) I ETAPA, PARROQUIA FÁTIMA, CANTÓN Y PROVINCIA DE PASTAZA "



RUBRO	912
DESCRIPCION	TRATAMIENTO PINTURA ESTRUCTURA ACERO A36 (FONDO+PINTURA ANTICORROSIVA), A COMPRESOR
UNIDAD	Kg
PERIODO	1 DE JUNIO 2021 A 30 DE JUNIO 2021

ANEXO: 2

CERRAMIENTO MALLA PTAR

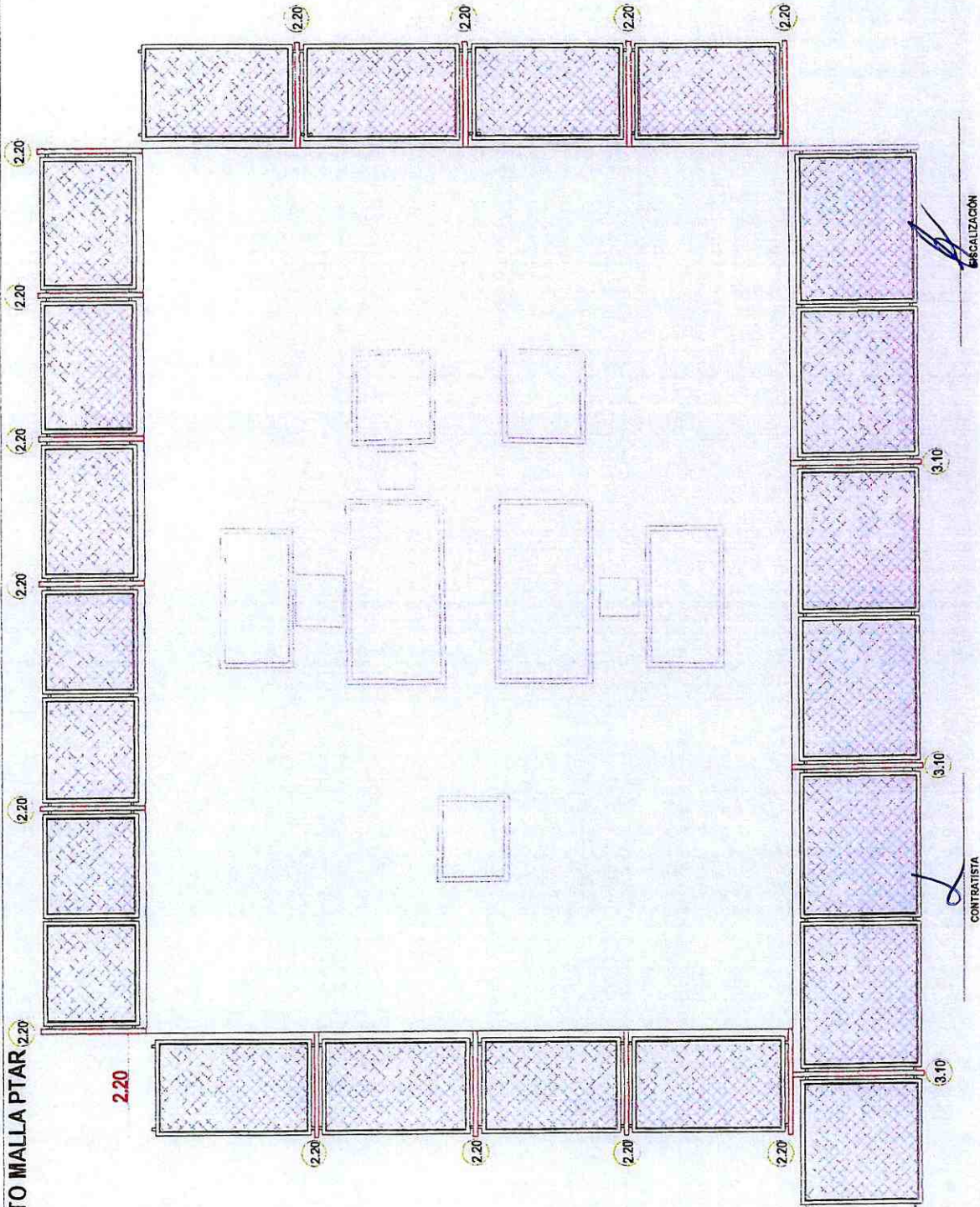

CONTRATISTA

ESCALIZACIÓN

GOBIERNO AUTÓNOMO DESCENTRALIZADO DE LA PROVINCIA DEL PASTAZA

PROYECTO " CONSTRUCCIÓN DE LOS HANGARES DEL GOBIERNO AUTÓNOMO DESCENTRALIZADO PROVINCIAL DE PASTAZA (GADPPz) I ETAPA, PARROQUIA FÁTIMA, CANTÓN Y PROVINCIA DE PASTAZA "

PLANILLA DE AVANCE DE OBRA No. 23

RUBRO N° 246 ANEXO 1
 DESCRIPCIÓN: PICADO Y RESANADO DE mAmPOSTERIA PARA INSTALACIONES
 UNIDAD: m
 PERIODO: 01-jun 30-jun



1 DE 1

PICADO Y RESANE DE INSTALACIONES NAVE DE DESECHOS						
DESCRIPCION	LARGO (X)	ANCHO (Y)	ALTO (Z)	No.	SUBTOTAL	TOTAL
PICADO Y CORCHADO DE TUBERIAS PARA INSTALACIONES						
TUB DE AGUA			2,50	4,00	10,00	10,00
					SUBTOTAL 1	10,00

PICADO Y CORCHADO DE TUBERIAS PARA INSTALACIONES						
TUB DE DESAGUE			2,50	4,00	10,00	10,00
					SUBTOTAL 2	10,00

PICADO Y CORCHADO DE TUBERIAS PARA INSTALACIONES ELECTRICAS ELECTRONICAS						
TUB DE FUERZA			2,70	13,00	35,10	35,10
TUB DE ILUMINACIÓN			1,85	31,00	57,35	57,35
CANALETA			7,55	1,00	7,55	7,55
					SUBTOTAL 3	100,00

RESUMEN DE PLANILLA AL 100%					
DESCRIPCION	CONTRATADO	ANTERIOR	ACTUAL	ACUMULADO	UNIDAD
PICADO Y RESANADO DE mAmPOSTERIA PARA INSTALACIONES	120,00	-	120,00	120,00	m



 CONTRATISTA



 FISCALIZACIÓN

GOBIERNO AUTÓNOMO DESCENTRALIZADO DE LA
PROVINCIA DEL PASTAZA

" CONSTRUCCIÓN DE LOS HANGARES DEL GOBIERNO AUTÓNOMO DESCENTRALIZADO PROVINCIAL DE PASTAZA
(GADPPz) I ETAPA, PARROQUIA FÁTIMA, CANTÓN Y PROVINCIA DE PASTAZA "

PROYECTO:

RUBRO	246
DESCRIPCION	PICADO Y RESANADO DE mAmPOSTERIA PARA INSTALACIONES
UNIDAD	m
PERIODO	1 DE JUNIO 2021 A 30 DE JUNIO 2021

ANEXO: 1



UBICACION - NAVE DE DESECHOS

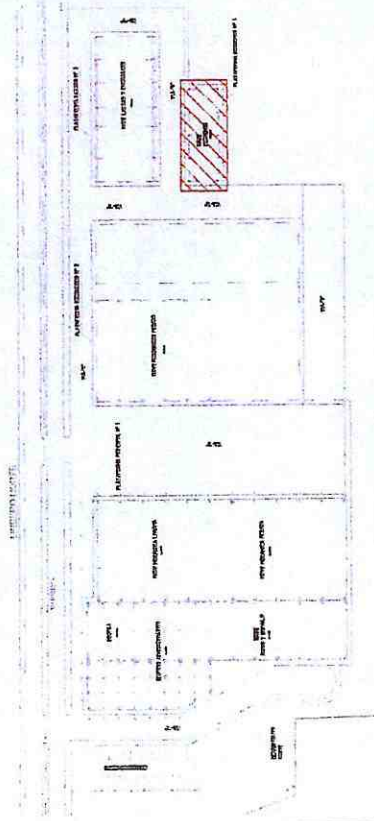

UBICACION - ENLUCIDO EXTERIOR

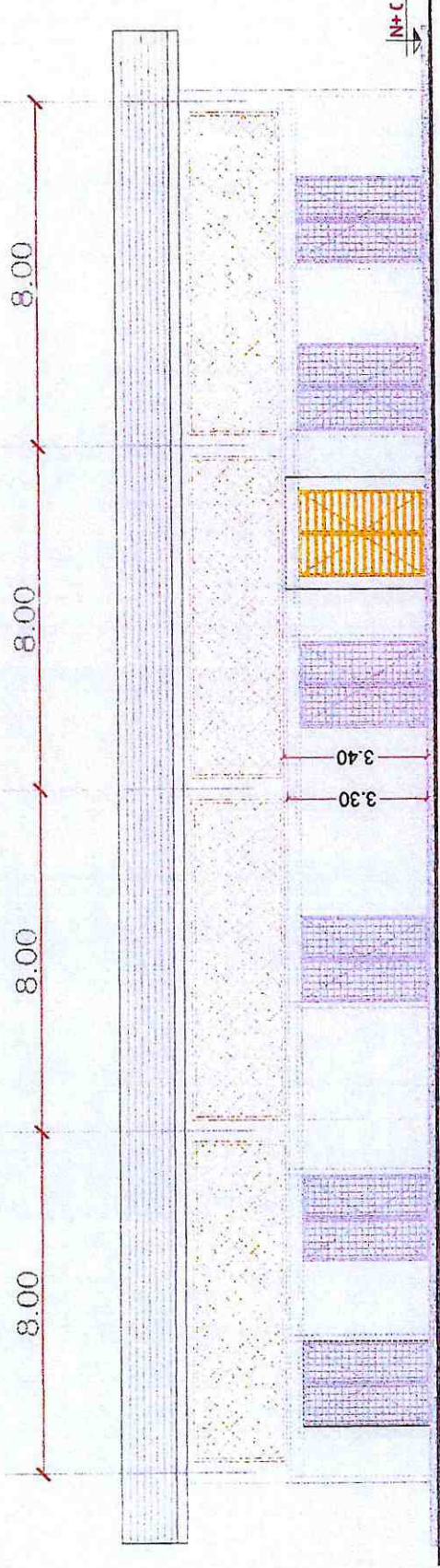
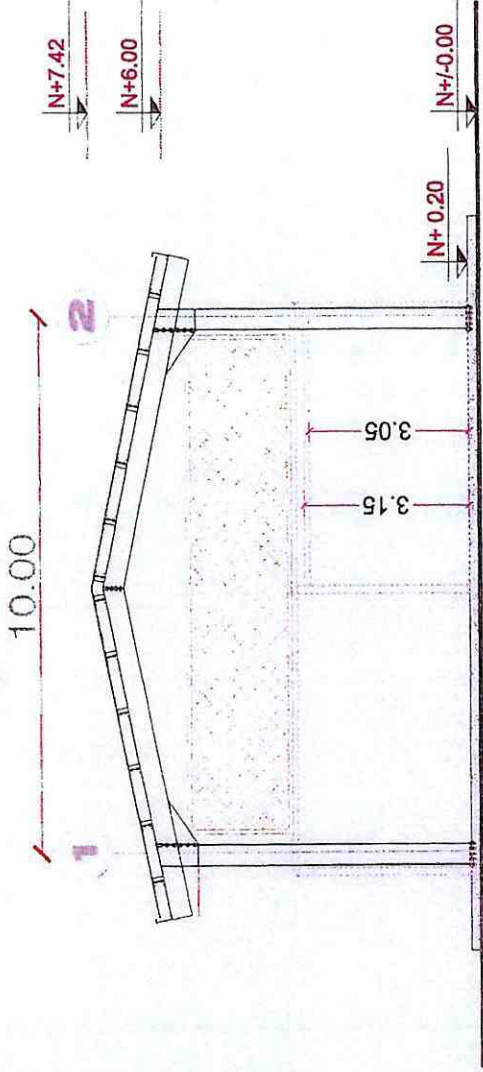

FACHADA NORTE - ENLUCIDO EXTERIOR

CONTRATISTA

FISCALIZACIÓN

G **BIEN GOBIERNO AUTONOMO DESCENTRALIZADO DE**
PROVINCIA DEL PASTAZA

" CONSTRUCCIÓN DE LOS HANGARES DEL GOBIERNO AUTÓNOMO DESCENTRALIZADO PROVINCIAL DE PASTAZA
 (GADPPz) I ETAPA, PARROQUIA FÁTIMA, CANTÓN Y PROVINCIA DE PASTAZA "



PROYECTO:	ANEXO: 2		
RUBRO	246	PICADO Y RESANADO DE mamposteria PARA INSTALACIONES	
DESCRIPCION	m		
UNIDAD			
PERIODO	1	DE JUNIO 2021 A 30 DE JUNIO 2021	

UBICACION - NAVE DE DESECHOS

ENLUCIDO EXTERIOR

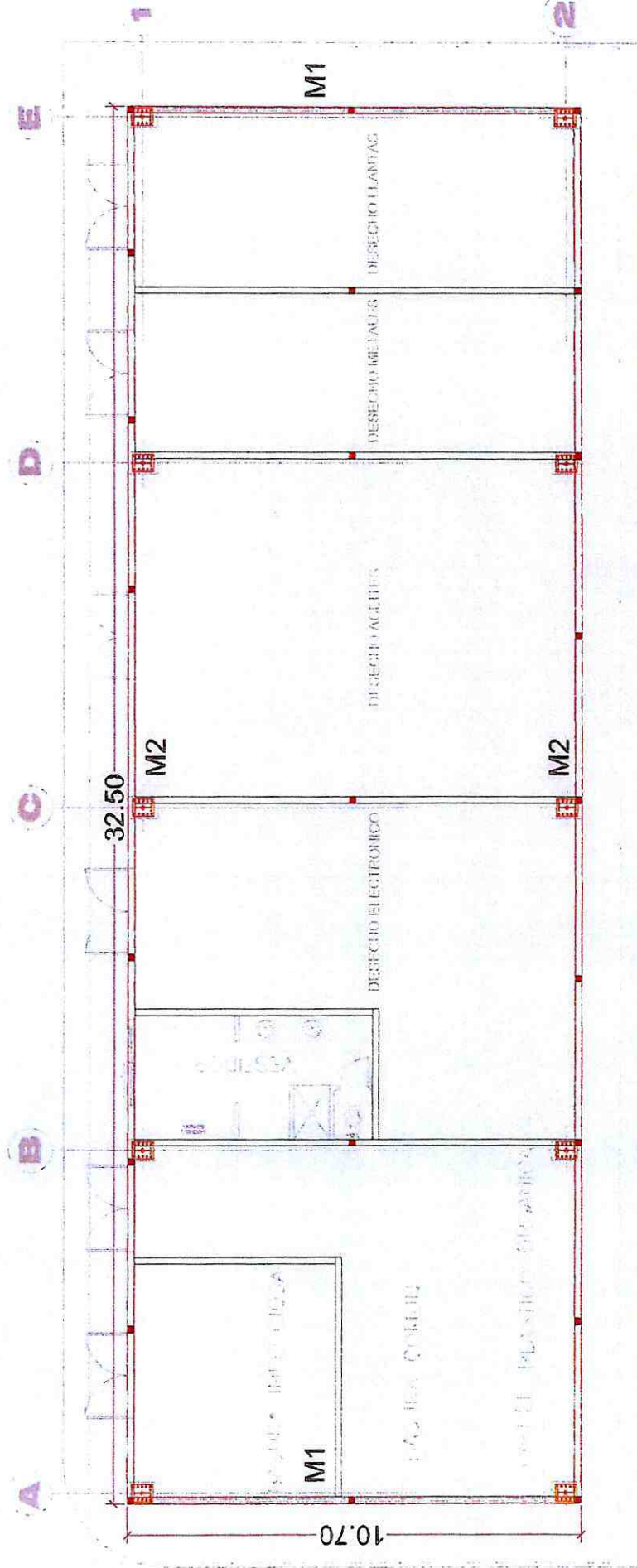

[Signature]
 CONTRATISTA

[Signature]
 LOCALIZACIÓN

PROYECTO "CONSTRUCCIÓN DE LOS HANGARES DEL GOBIERNO AUTÓNOMO DESCENTRALIZADO PROVINCIAL DE PASTAZA (GADPP2) I ETAPA, PARROQUIA FÁTIMA, CANTÓN Y PROVINCIA DE PASTAZA "

PLANILLA DE AVANCE DE OBRA No. 23

RUBRO N° 247 ANEXO 1
 DESCRIPCIÓN: MESON H.A. FC=180 KG/CM2 E=7 CM HIERRO (LAVAMANOS+MESON)
 UNIDAD: m
 PERIODO: 01-jun 30-jun



PAG. 1 DE 1

MESON H.A. FC=180 KG/CM2 E=7 CM HIERRO (LAVAMANOS+MESON)						
NAVE DE DESECHOS						
DESCRIPCION	LARGO (X)	ANCHO (Y)	ALTO (Z)	No.	SUBTOTAL	TOTAL
MESON	3,30			1,00	3,30	3,30
					TOTAL	3,30

RESUMEN DE PLANILLA AL 100%					
DESCRIPCION	CONTRATADO	ANTERIOR	ACTUAL	ACUMULADO	UNIDAD
MESON H.A. FC=180 KG/CM2 E=7 CM HIERRO (LAVAMANOS+MESON)	3,50	-	3,30	3,30	m



 CONTRATISTA



 FISCALIZACIÓN

G ERNO AUTONOMO DESCENTRALIZADO DE
PROVINCIA DEL PASTAZA

* CONSTRUCCIÓN DE LOS HANGARES DEL GOBIERNO AUTÓNOMO DESCENTRALIZADO PROVINCIAL DE PASTAZA
 (GADPPz) I ETAPA, PARROQUIA FÁTIMA, CANTÓN Y PROVINCIA DE PASTAZA *

PROYECTO:

RUBRO	247	ANEXO: 1
DESCRIPCION	MESON H.A. F'C=180 KG/CM2 E=7 CM HIERRO (LAVAMANOS+MESON)	
UNIDAD	m	
PERIODO	1 DE JUNIO 2021 A 30 DE JUNIO 2021	



UBICACION - NAVE DE DESECHOS

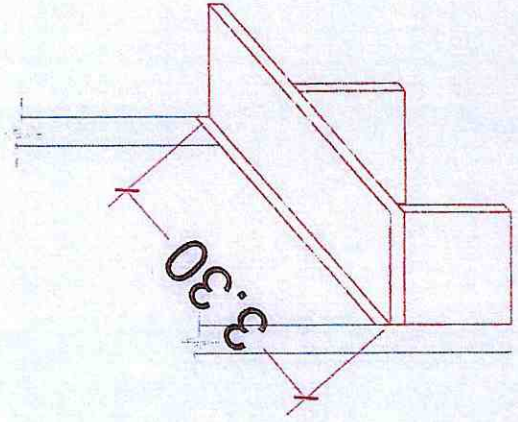
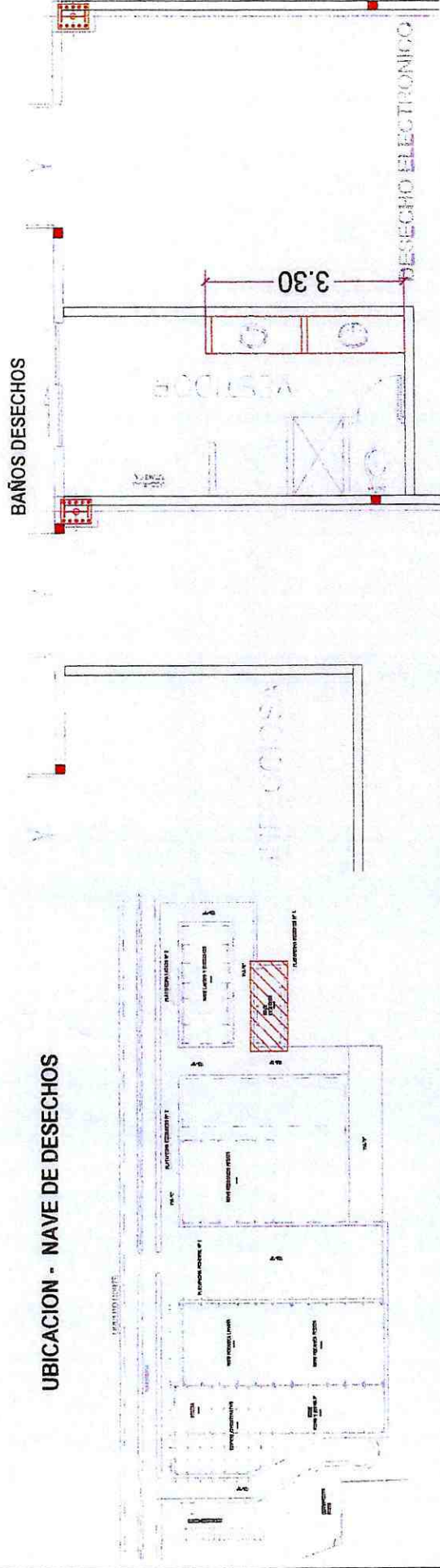

PERSPECTIVA DESECHOS

CONTRATISTA

FISCALIZACIÓN

PROYECTO * CONSTRUCCIÓN DE LOS HANGARES DEL GOBIERNO AUTÓNOMO DESCENTRALIZADO PROVINCIAL DE PASTAZA (GADPPz) I ETAPA, PARROQUIA FÁTIMA, CANTÓN Y PROVINCIA DE PASTAZA *
 PLANILLA DE AVANCE DE OBRA No. 23

RUBRO N° 248 ANEXO 1
 DESCRIPCIÓN: REVESTIMIENTO MESON GRANITO
 UNIDAD: m
 PERIODO: 01-jun 30-jun



PAG. 1 DE 1

REVESTIMIENTO MESON GRANITO						
NAVE DE DESECHOS						
DESCRIPCION	LARGO (X)	ANCHO (Y)	ALTO (Z)	No.	SUBTOTAL	TOTAL
MESON	3,30			1,00	3,30	3,30
	0,88			1,00	0,88	0,88
	0,77			1,00	0,77	0,77
TOTAL						4,95

RESUMEN DE PLANILLA AL 100%					
DESCRIPCION	CONTRATADO	ANTERIOR	ACTUAL	ACUMULADO	UNIDAD
REVESTIMIENTO MESON GRANITO	3,50	-	3,50	3,50	m

RESUMEN DE PLANILLA DE INCREMENTOS						
DESCRIPCION	CONTRATADO	ANTERIOR	ACTUAL	INCR. ANT.	INCR. ACT.	UNIDAD
REVESTIMIENTO MESON GRANITO	3,50	0,00			1,45	m

 CONTRATISTA

 FISCALIZACIÓN

" CONSTRUCCIÓN DE LOS HANGARES DEL GOBIERNO AUTÓNOMO DESCENTRALIZADO PROVINCIAL DE PASTAZA
 (GADPPz) I ETAPA, PARROQUIA FÁTIMA, CANTÓN Y PROVINCIA DE PASTAZA "

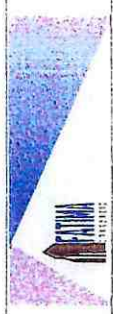

PROYECTO:	ANEXO: 1		
RUBRO	248		
DESCRIPCION	REVESTIMIENTO MESON GRANITO		
UNIDAD	m		
PERIODO	1 DE JUNIO 2021 A 30 DE JUNIO 2021		

UBICACION - NAVE DE DESECHOS

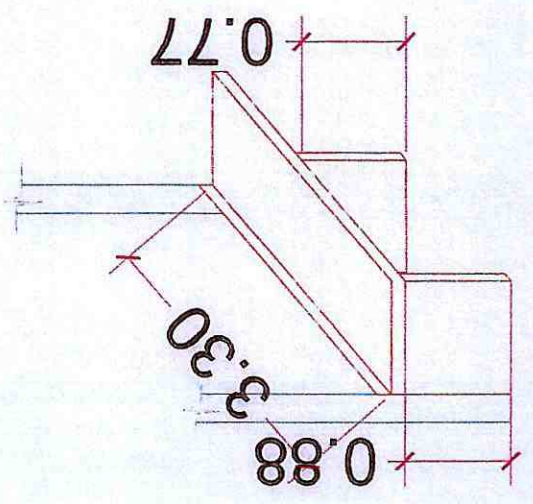
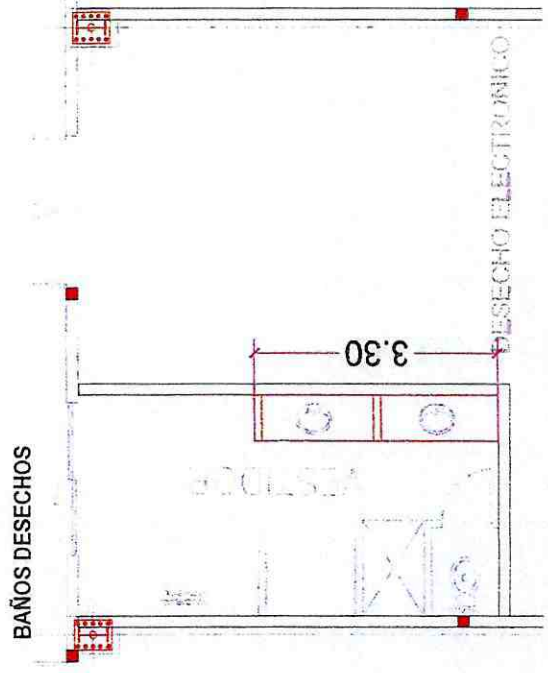
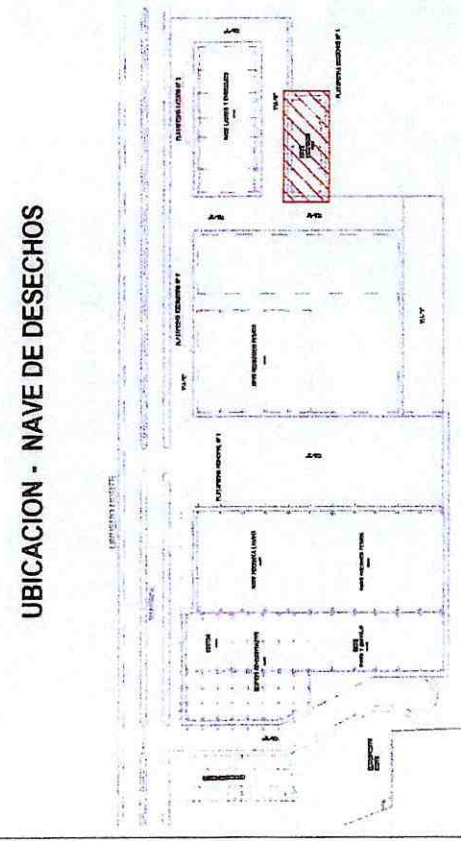

PERSPECTIVA DESECHOS

CONTRATISTA

FISCALIZACIÓN

GOBIERNO AUTÓNOMO DESCENTRALIZADO DE LA PROVINCIA DEL PASTAZA

PROYECTO " CONSTRUCCIÓN DE LOS HANGARES DEL GOBIERNO AUTÓNOMO DESCENTRALIZADO PROVINCIAL DE PASTAZA (GADPP2) I ETAPA, PARROQUIA FÁTIMA, CANTÓN Y PROVINCIA DE PASTAZA "

PLANILLA DE AVANCE DE OBRA No. 23

RUBRO N° 259 ANEXO 1
 DESCRIPCIÓN: PUERTA METÁLICA PANELADA TOOL GALV. 2MM , INC. CERRADURA, BISAGRAS Y PINTURA
 UNIDAD: m2
 PERIODO: 01-jun 30-jun



PAG. 1 DE 1

PUERTA METÁLICA PANELADA TOOL GALV. 2MM , INC. CERRADURA, BISAGRAS Y PINTURA						
NAVE DE DESECHOS						
DESCRIPCION	LARGO (X)	ANCHO (Y)	ALTO (Z)	No.	SUBTOTAL	TOTAL
PUERTA METÁLICA PANELADA TOOL GALV. 2MM , INC. CERRADURA, BISAGRAS Y PINTURA	3,00	2,00		6,00	36,00	36,00

RESUMEN DE PLANILLA AL 100%					
DESCRIPCION	CONTRATADO	ANTERIOR	ACTUAL	ACUMULADO	UNIDAD
PUERTA METÁLICA PANELADA TOOL GALV. 2MM , INC. CERRADURA, BISAGRAS Y PINTURA	40,00	-	36,00	36,00	m2

 CONTRATISTA

 FISCALIZACIÓN

GOBIERNO AUTÓNOMO DESCENTRALIZADO DE PASTAZA
PROVINCIA DEL PASTAZA

" CONSTRUCCIÓN DE LOS HANGARES DEL GOBIERNO AUTÓNOMO DESCENTRALIZADO PROVINCIAL DE PASTAZA (GADPPz) I ETAPA, PARROQUIA FÁTIMA, CANTÓN Y PROVINCIA DE PASTAZA "

PROYECTO:
 RUBRO 259
 DESCRIPCIÓN PUERTA METÁLICA PANELADA TOOL GALV. 2MM , INC. CERRADURA, BISAGRAS Y PINTURA
 UNIDAD m²
 PERIODO 1 DE JUNIO 2021 A 30 DE JUNIO 2021

ANEXO: 1



UBICACION - ENLUCIDO EXTERIOR

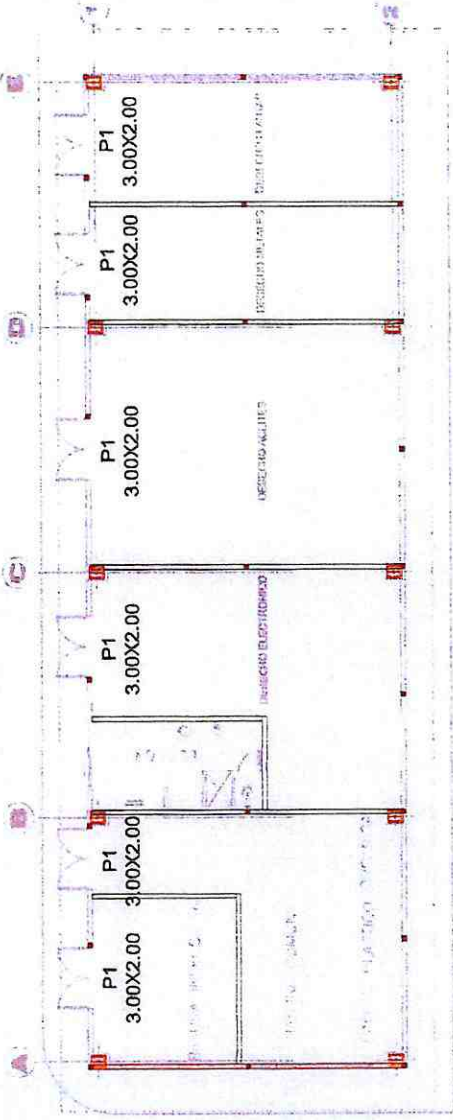

UBICACION - NAVE DE DESECHOS

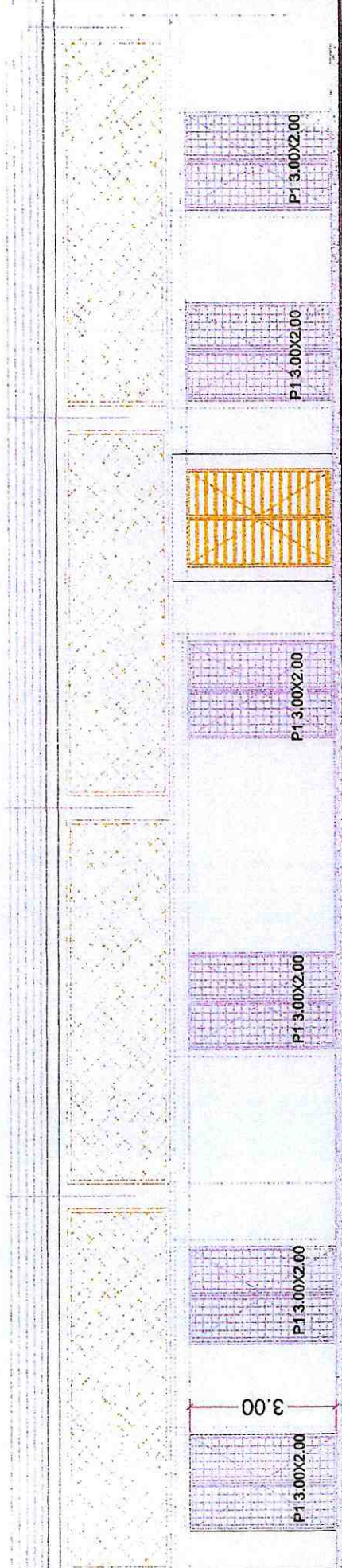
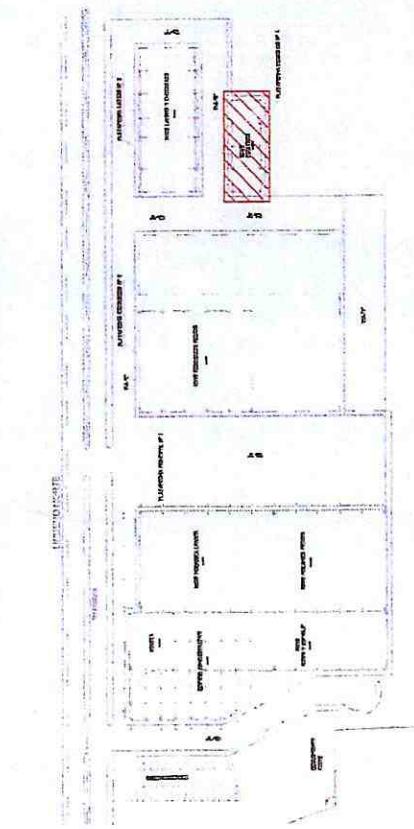

[Signature]
 CONTRATISTA

FACHADA NORTE - ENLUCIDO EXTERIOR

[Signature]
 FISCALIZACIÓN

PROYECTO * CONSTRUCCIÓN DE LOS HANGARES DEL GOBIERNO AUTÓNOMO DESCENTRALIZADO PROVINCIAL DE PASTAZA (GADPPz) I ETAPA, PARROQUIA FÁTIMA, CANTÓN Y PROVINCIA DE PASTAZA *
PLANILLA DE AVANCE DE OBRA No. 23

RUBRO N° 260 ANEXO 1
DESCRIPCIÓN: PUERTAS MODULARES, TAMBORADAS PARA BAÑOS EN ACERO INOXIDABLE E=1MM AISI 304, INCLUYE
UNIDAD: m2
PERIODO: 01-jun 30-jun



PAG. 1 DE 1

PUERTAS MODULARES, TAMBORADAS PARA BAÑOS EN ACERO INOXIDABLE E=1MM AISI 304, INCLUYE ESTRUCTURA Y HER

NAVE DE DESECHOS

DESCRIPCION	LARGO (X)	ANCHO (Y)	ALTO (Z)	No.	SUBTOTAL	TOTAL
PUERTAS MODULARES, TAMBORADAS PARA BAÑOS EN ACERO INOXIDABLE	0,68	1,47		1,00	1,00	1,00

RESUMEN DE PLANILLA AL 100%

DESCRIPCION	CONTRATADO	ANTERIOR	ACTUAL	ACUMULADO	UNIDAD
PUERTAS MODULARES, TAMBORADAS PARA BAÑOS EN ACERO INOXIDABLE E=1MM AISI 304, INCLUYE ESTRUCTURA Y HER	1,00	-	1,00	1,00	m2

CONTRATISTA

FISCALIZACIÓN

G BIENIO AUTONOMO DESCENTRALIZADO DE LA
PROVINCIA DEL PASTAZA

" CONSTRUCCIÓN DE LOS HANGARES DEL GOBIERNO AUTÓNOMO DESCENTRALIZADO PROVINCIAL DE PASTAZA
 (GADPPz) | ETAPA, PARROQUIA FÁTIMA, CANTÓN Y PROVINCIA DE PASTAZA "



PROYECTO:	ANEXO: 1
RUBRO	280
DESCRIPCION	PUERTAS MODULARES, TAMBORADAS PARA BAÑOS EN ACERO INOXIDABLE E=1MM AISI 304, INCLUYE ESTRUCTURA Y HER
UNIDAD	m ²
PERIODO	1 DE JUNIO 2021 A 30 DE JUNIO 2021

UBICACION - NAVE DE DESECHOS

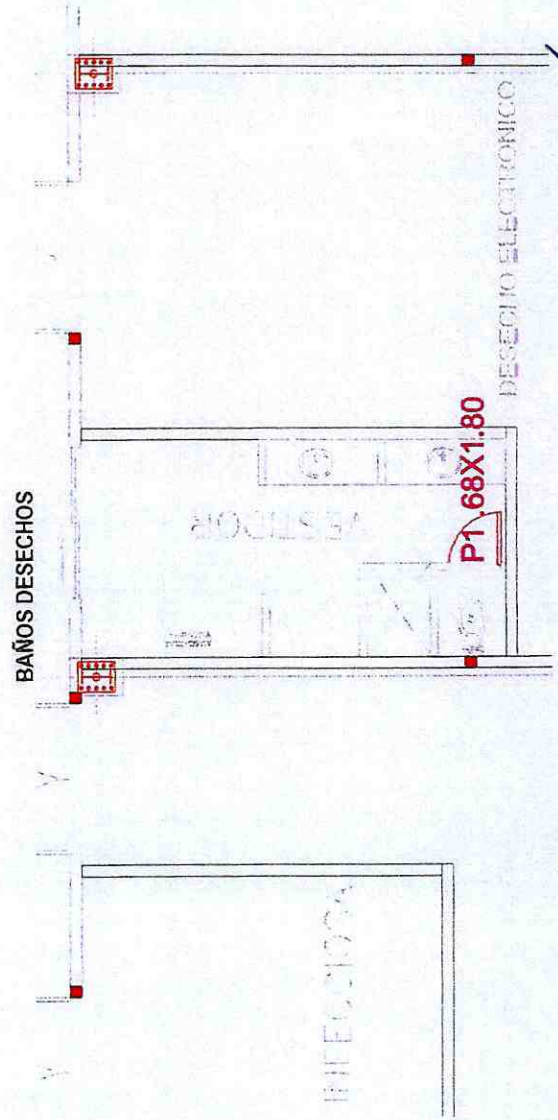
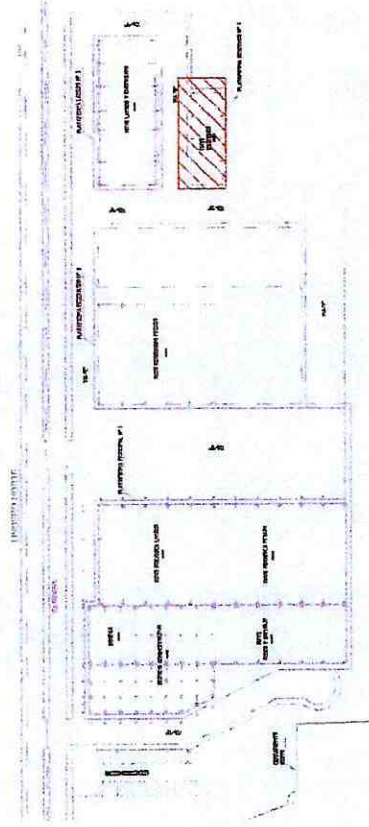

[Signature]
 FISCALIZACIÓN

[Signature]
 CONTRATISTA

GOBIERNO AUTÓNOMO DESCENTRALIZADO DE LA PROVINCIA DEL PASTAZA

PROYECTO " CONSTRUCCIÓN DE LOS HANGARES DEL GOBIERNO AUTÓNOMO DESCENTRALIZADO PROVINCIAL DE PASTAZA (GADPP2) I ETAPA, PARROQUIA FÁTIMA, CANTÓN Y PROVINCIA DE PASTAZA "

PLANILLA DE AVANCE DE OBRA No. 23

RUBRO N° 271 ANEXO 1
 DESCRIPCIÓN: DISPENSOR DE PAPEL HIGIENICO DIAM=275MM, ROLLO 70MM, ABATIBLE,ACERO INOX E=8MM, AISI 304.
 UNIDAD: u
 PERIODO: 01-jun 30-jun



PAG. 1 DE 1

DISPENSOR DE PAPEL HIGIENICO DIAM=275MM, ROLLO 70MM, ABATIBLE,ACERO INOX E=8MM, AISI 304. ACABADO S				
NAVE DE DESECHOS				
DESCRIPCION	CANTIDAD	DIMENSION	TOTAL	GRAFICO #
VESTIDOR	1,00	-	1,00	ANEXO # 1
			TOTAL	1,00

RESUMEN DE PLANILLA AL 100%					
DESCRIPCION	CONTRATADO	ANTERIOR	ACTUAL	ACUMULADO	UNIDAD
DISPENSOR DE PAPEL HIGIENICO DIAM=275MM, ROLLO 70MM, ABATIBLE,ACERO INOX E=8MM, AISI 304. ACABADO S	1,00	-	1,00	1,00	u

 CONTRATISTA

 FISCALIZACIÓN

BIENIO AUTONOMO DESCENTRALIZADO DE
PROVINCIA DEL PASTAZA

" CONSTRUCCIÓN DE LOS HANGARES DEL GOBIERNO AUTÓNOMO DESCENTRALIZADO PROVINCIAL DE PASTAZA
(GADPPPZ) I ETAPA, PARROQUIA FÁTIMA, CANTÓN Y PROVINCIA DE PASTAZA "

RUBRO 271
DESCRIPCIÓN DISPENSADOR DE PAPEL HIGIENICO DIAM=275MM, ROLLO 70MM, ABATIBLE ACERO INOX E-8MM, AISI 304, ACABADO S
UNIDAD U
PERIODO 1 DE JUNIO 2021 A 30 DE JUNIO 2021

ANEXO: 1

UBICACION - NAVE DE DESECHOS

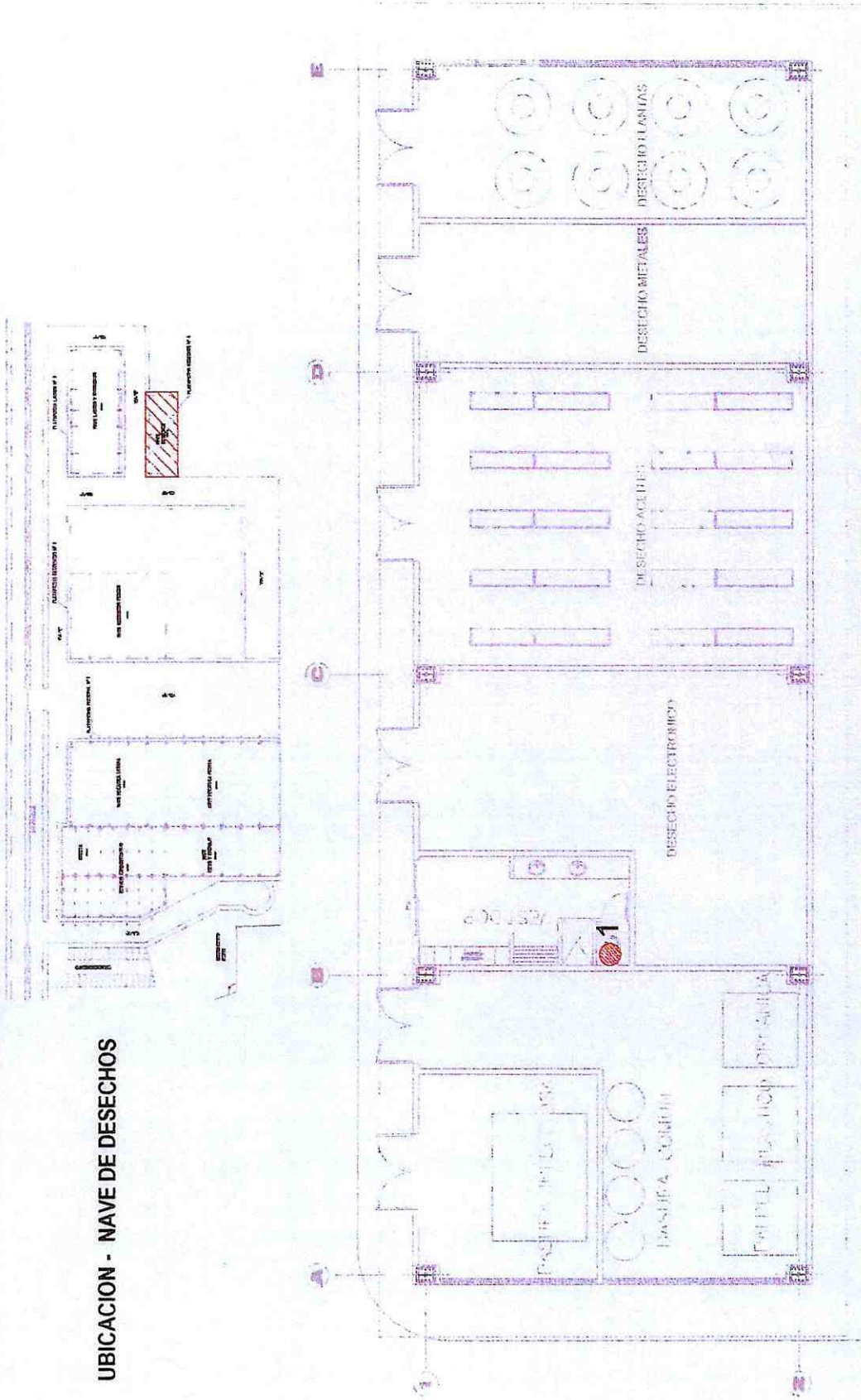

PLANTA ARQUITECTONICA - DISPENSADOR PAPEL HIGIENICO

[Signature]
CONTRATISTA

[Signature]
FISCALIZACIÓN

GOBIERNO AUTÓNOMO DESCENTRALIZADO DE LA PROVINCIA DEL PASTAZA

PROYECTO * CONSTRUCCIÓN DE LOS HANGARES DEL GOBIERNO AUTÓNOMO DESCENTRALIZADO PROVINCIAL DE PASTAZA (GADPPz) I ETAPA, PARROQUIA FÁTIMA, CANTÓN Y PROVINCIA DE PASTAZA *

PLANILLA DE AVANCE DE OBRA No. 23

RUBRO N° 272 ANEXO 1
 DESCRIPCIÓN: DISPENSOR DE PAPEL TOALLA 400-600 UNIDADES, 330X273X130MM, ACERO INOX E=8MM AISI 304,
 UNIDAD: u
 PERIODO: 01-jun 30-jun



PAG. 1 DE 1

DISPENSOR DE PAPEL TOALLA 400-600 UNIDADES, 330X273X130MM, ACERO INOX E=8MM AISI 304, ACABADO SATINAD				
NAVE DE DESECHOS				
DESCRIPCION	CANTIDAD	DIMENSION	TOTAL	GRAFICO #
VESTIDOR	1,00	-	1,00	ANEXO # 1
TOTAL			1,00	

RESUMEN DE PLANILLA AL 100%					
DESCRIPCION	CONTRATADO	ANTERIOR	ACTUAL	ACUMULADO	UNIDAD
DISPENSOR DE PAPEL TOALLA 400-600 UNIDADES, 330X273X130MM, ACERO INOX E=8MM AISI 304, ACABADO SATINAD	1,00	-	1,00	1,00	u



 CONTRATISTA



 FISCALIZACIÓN

" CONSTRUCCIÓN DE LOS HANGARES DEL GOBIERNO AUTÓNOMO DESCENTRALIZADO PROVINCIAL DE PASTAZA
 (GADPPz) I ETAPA, PARROQUIA FÁTIMA, CANTÓN Y PROVINCIA DE PASTAZA "



PROYECTO:	" CONSTRUCCIÓN DE LOS HANGARES DEL GOBIERNO AUTÓNOMO DESCENTRALIZADO PROVINCIAL DE PASTAZA (GADPPz) I ETAPA, PARROQUIA FÁTIMA, CANTÓN Y PROVINCIA DE PASTAZA "		
RUBRO	272	ANEXO:	1
DESCRIPCION	DISPENSADOR DE PAPEL TOALLA 400-600 UNIDADES, 330X273X130MM, ACERO INOX E=8MM AISI 304, ACABADO SATINAD		
UNIDAD	U		
PERIODO	1 DE JUNIO 2021 A 30 DE JUNIO 2021		

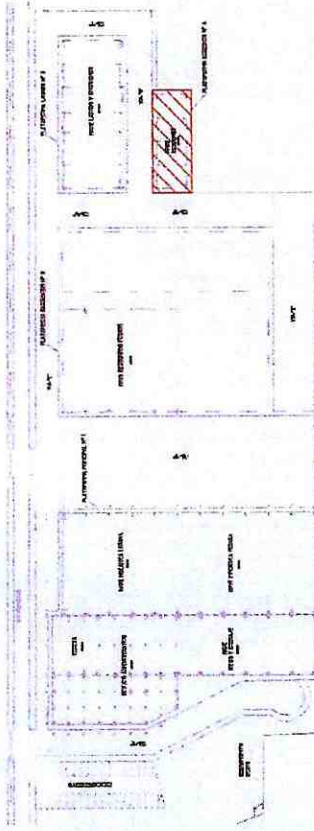

UBICACION - NAVE DE DESECHOS

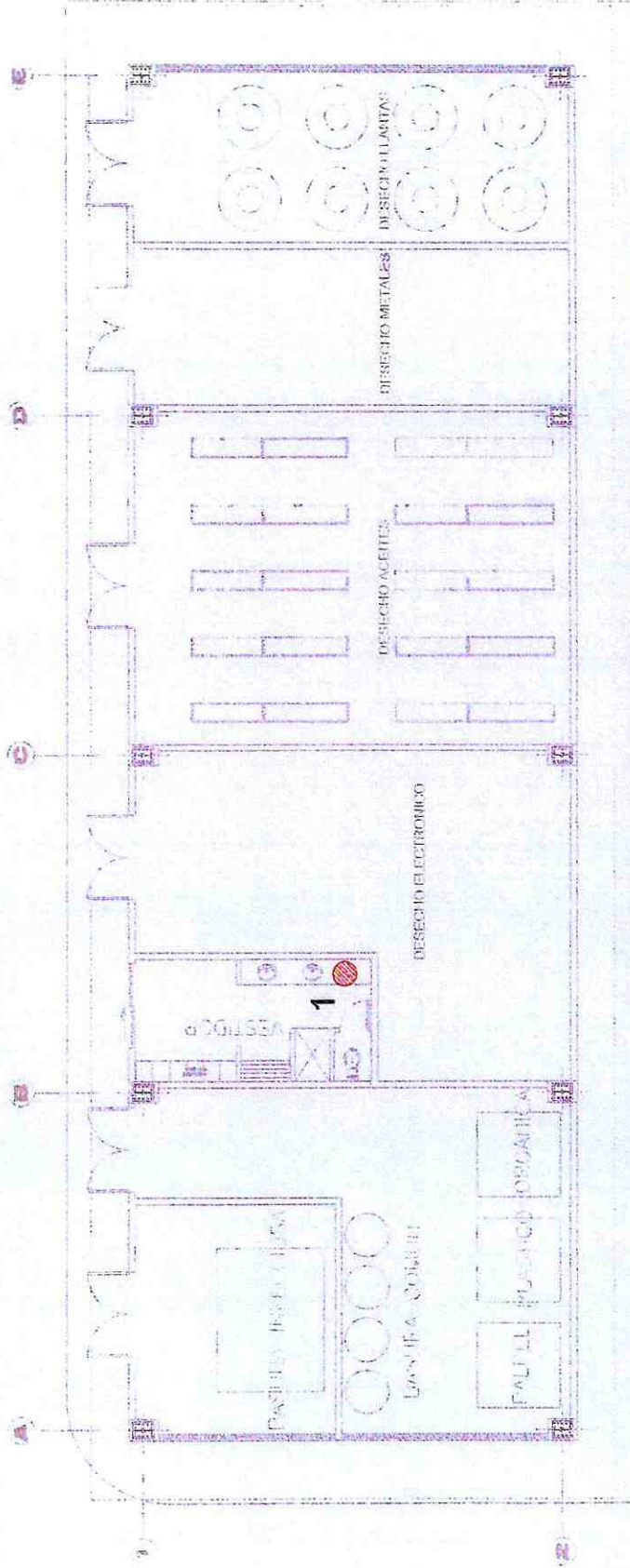

PLANTA ARQUITECTONICA - DISPENSADOR PAPEL TOALLA

[Signature]
 CONTRATISTA

[Signature]
 EJECUCION

PROYECTO "CONSTRUCCIÓN DE LOS HANGARES DEL GOBIERNO AUTÓNOMO DESCENTRALIZADO PROVINCIAL DE PASTAZA (GADPPz) I ETAPA, PARROQUIA FÁTIMA, CANTÓN Y PROVINCIA DE PASTAZA"

PLANILLA DE AVANCE DE OBRA No. 23

RUBRO N° 273 ANEXO 1
 DESCRIPCIÓN: DISPENSADOR DE JABON LIQUIDO ACERO INOX AISI304, ACABADO SATINADO
 UNIDAD: u
 PERIODO: 01-jun 30-jun



PAG. 1 DE 1

DISPENSADOR DE JABON LIQUIDO ACERO INOX AISI304, ACABADO SATINADO				
NAVE DE DESECHOS				
DESCRIPCION	CANTIDAD	DIMENSION	TOTAL	GRAFICO #
VESTIDOR	1,00	-	1,00	ANEXO # 1
			TOTAL	1,00

RESUMEN DE PLANILLA AL 100%					
DESCRIPCION	CONTRATADO	ANTERIOR	ACTUAL	ACUMULADO	UNIDAD
DISPENSADOR DE JABON LIQUIDO ACERO INOX AISI304, ACABADO SATINADO	1,00	-	1,00	1,00	u

 CONTRATISTA

 FISCALIZACIÓN

" CONSTRUCCIÓN DE LOS HANGARES DEL GOBIERNO AUTÓNOMO DESCENTRALIZADO PROVINCIAL DE PASTAZA
 (GADPPz) I ETAPA, PARROQUIA FÁTIMA, CANTÓN Y PROVINCIA DE PASTAZA "



ANEXO: 1	
RUBRO	273
DESCRIPCION	DISPENSADOR DE JABON LIQUIDO ACERO INOX AISI304, ACABADO SATINADO
UNIDAD	U
PERIODO	1 DE JUNIO 2021 A 30 DE JUNIO 2021

UBICACION - NAVE DE DESECHOS

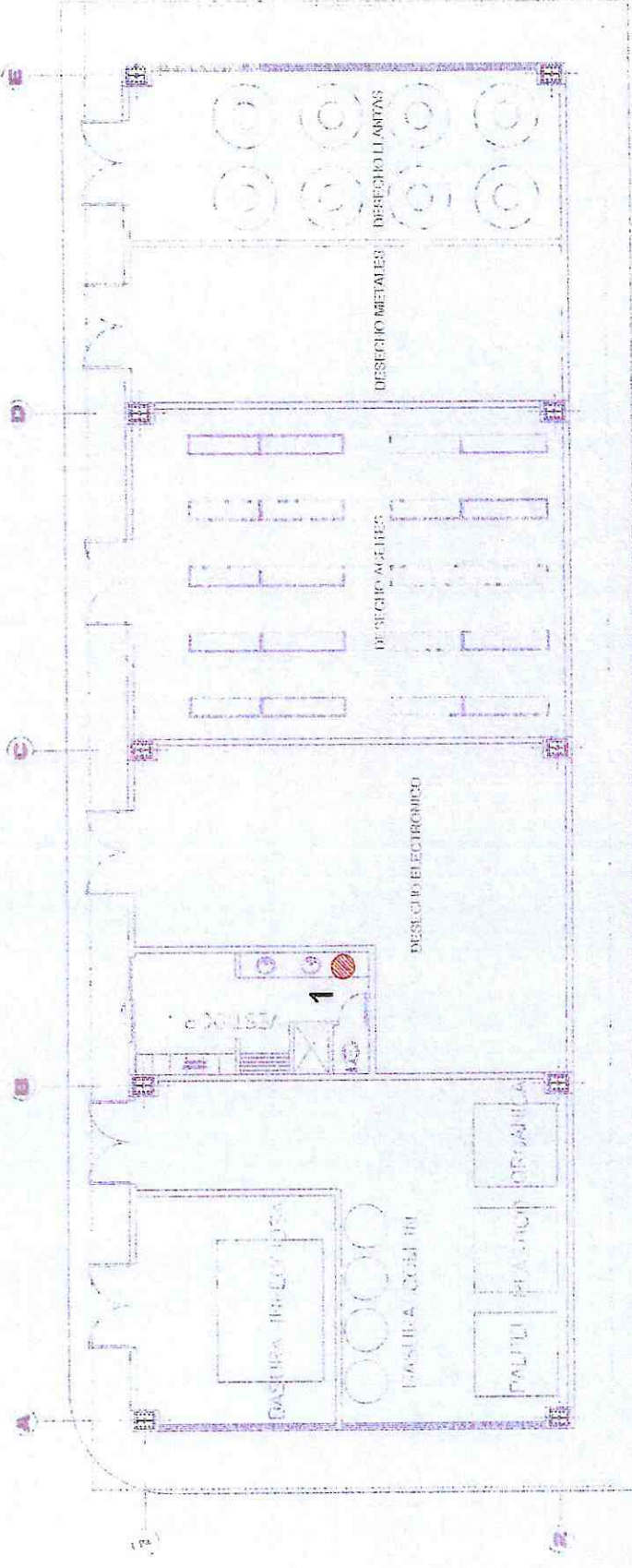
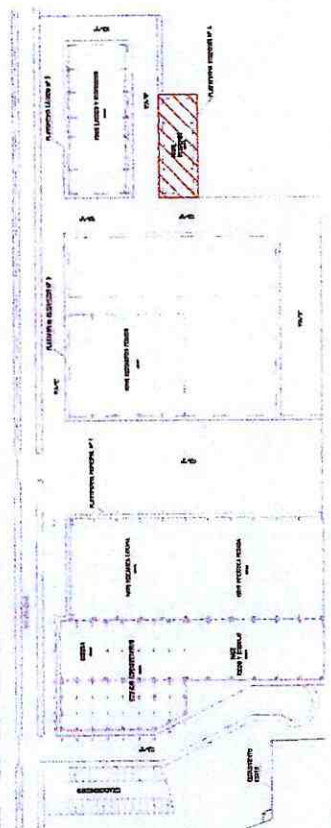

PLANTA ARQUITECTONICA - DISPENSADOR JABON LIQUIDO

CONTRATISTA

FISCALIZACIÓN

PROYECTO " CONSTRUCCIÓN DE LOS HANGARES DEL GOBIERNO AUTÓNOMO DESCENTRALIZADO PROVINCIAL DE PASTAZA (GADPPz) I ETAPA, PARROQUIA FÁTIMA, CANTÓN Y PROVINCIA DE PASTAZA "

PLANILLA DE AVANCE DE OBRA No. 23

RUBRO N° 274 ANEXO 1
 DESCRIPCIÓN: ESPEJO DE VIDRIO FLOTADO 4MM- MARCO DE ALUMINIO
 UNIDAD: m2
 PERIODO: 01-jun 30-jun



PAG. 1 DE 1

ESPEJO DE VIDRIO FLOTADO 4MM- MARCO DE ALUMINIO						
NAVE DE DESECHOS						
DESCRIPCION	LARGO (X)	ANCHO (Y)	ALTO (Z)	No.	SUBTOTAL	TOTAL
A1	3,00		0,90	1,00	2,70	2,70
					TOTAL	2,70

RESUMEN DE PLANILLA AL 100%					
DESCRIPCION	CONTRATADO	ANTERIOR	ACTUAL	ACUMULADO	UNIDAD
ESPEJO DE VIDRIO FLOTADO 4MM- MARCO DE ALUMINIO	2,70	-	2,70	2,70	m2



 CONTRATISTA



 FISCALIZACIÓN

BIENIO AUTONOMO DESCENTRALIZADO DE
 PROVINCIA DEL PASTAZA

" CONSTRUCCIÓN DE LOS HANGARES DEL GOBIERNO AUTÓNOMO DESCENTRALIZADO PROVINCIAL DE PASTAZA
 (GADPPz) I ETAPA, PARROQUIA FÁTIMA, CANTÓN Y PROVINCIA DE PASTAZA "



RUBRO	274	ANEXO: 1
DESCRIPCION	ESPEJO DE VIDRIO FLOTADO 4MM- MARCO DE ALUMINIO	
UNIDAD	U	
PERIODO	1 DE JUNIO 2021 A 30 DE JUNIO 2021	

UBICACION - NAVE DE DESECHOS

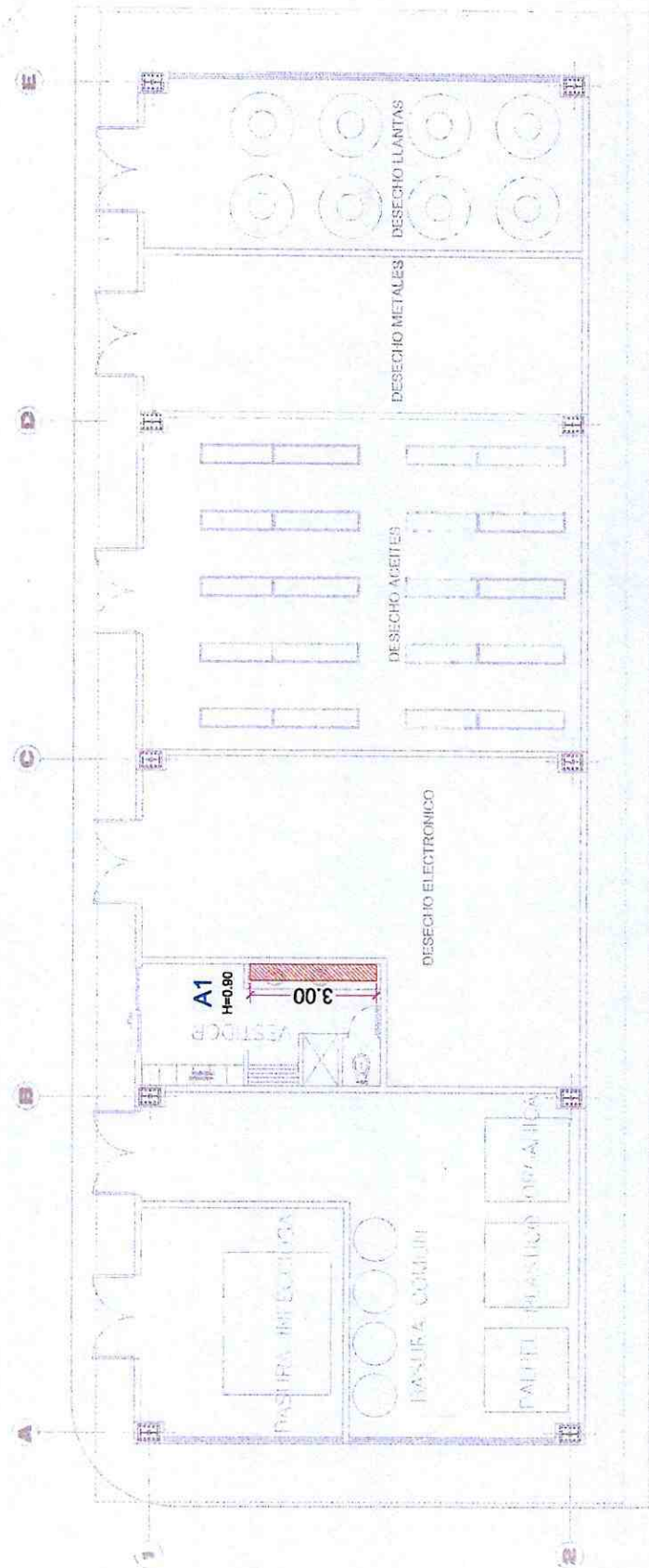
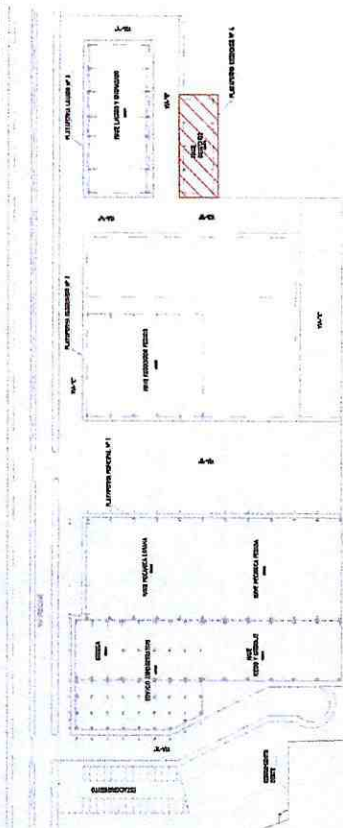

PLANTA ARQUITECTONICA - ESPEJO DE VIDRIO FLOTADO

CONTRATISTA

FISCALIZACION

GOBIERNO AUTÓNOMO DESCENTRALIZADO DE LA PROVINCIA DEL PASTAZA

PROYECTO "CONSTRUCCIÓN DE LOS HANGARES DEL GOBIERNO AUTÓNOMO DESCENTRALIZADO PROVINCIAL DE PASTAZA (GADPPz) I ETAPA, PARROQUIA FÁTIMA, CANTÓN Y PROVINCIA DE PASTAZA "

PLANILLA DE AVANCE DE OBRA No. 23

RUBRO N° 276 ANEXO 1
 DESCRIPCIÓN: BASURERO CILINDRICO A PEDAL D=250MM H=385 PARA BAÑO ACERO INOX. 304
 UNIDAD: u
 PERIODO: 01-jun 30-jun



PAG. 1 DE 1

BASURERO CILINDRICO A PEDAL D=250MM H=385 PARA BAÑO ACERO INOX. 304				
NAVE DE DESECHOS				
DESCRIPCION	CANTIDAD	DIMENSION	TOTAL	GRAFICO #
VESTIDOR	1,00	-	1,00	ANEXO # 1
TOTAL			1,00	

RESUMEN DE PLANILLA AL 100%					
DESCRIPCION	CONTRATADO	ANTERIOR	ACTUAL	ACUMULADO	UNIDAD
BASURERO CILINDRICO A PEDAL D=250MM H=385 PARA BAÑO ACERO INOX. 304	1,00	-	1,00	1,00	u



 CONTRATISTA



 FISCALIZACIÓN

**BIENIO AUTÓNOMO DESCENTRALIZADO DE
PROVINCIA DEL PASTAZA**

" CONSTRUCCIÓN DE LOS HANGARES DEL GOBIERNO AUTÓNOMO DESCENTRALIZADO PROVINCIAL DE PASTAZA
(GADPPz) | ETAPA, PARROQUIA FÁTIMA, CANTÓN Y PROVINCIA DE PASTAZA "

RUBRO	276	ANEXO: 1
DESCRIPCION	BASURERO CILINDRICO A PEDAL D=250MM H=385 PARA BAÑO ACERO INOX. 304	
UNIDAD	U	
PERIODO	1 DE JUNIO 2021 A 30 DE JUNIO 2021	



UBICACION - NAVE DE DESECHOS

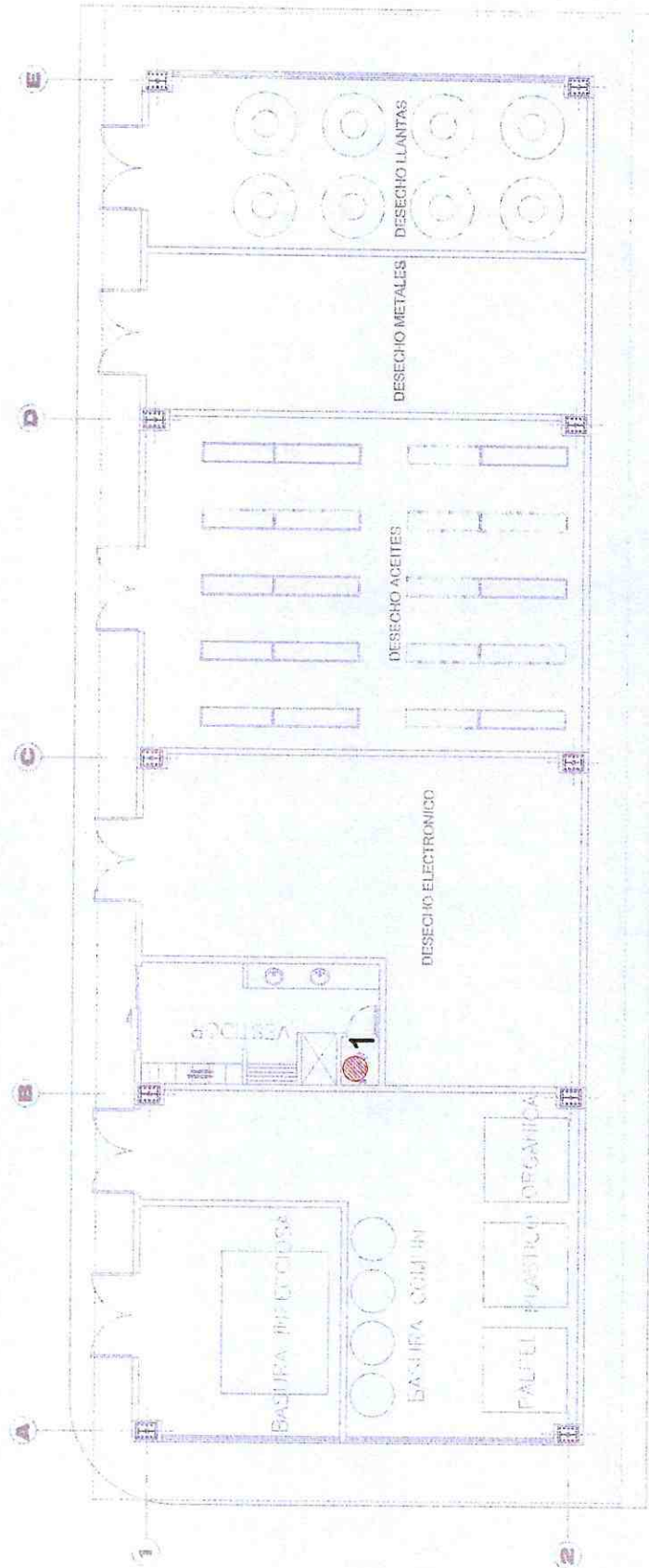

PLANTA ARQUITECTONICA - BASURERO CILINDRICO

CONTRATISTA _____
FISCALIZACIÓN _____

GOBIERNO AUTÓNOMO DESCENTRALIZADO DE LA PROVINCIA DEL PASTAZA

PROYECTO "CONSTRUCCIÓN DE LOS HANGARES DEL GOBIERNO AUTÓNOMO DESCENTRALIZADO PROVINCIAL DE PASTAZA (GADPPz) I ETAPA, PARROQUIA FÁTIMA, CANTÓN Y PROVINCIA DE PASTAZA "

PLANILLA DE AVANCE DE OBRA No. 23

RUBRO N° 277
 DESCRIPCIÓN: DUCHAS CON MEZCLADORA (CON ACCESORIOS)
 UNIDAD: u
 PERIODO: 01-jun 30-jun

ANEXO 1



PAG. 1 DE 1

DUCHAS CON MEZCLADORA (CON ACCESORIOS)				
NAVE DE DESECHOS				
DESCRIPCION	CANTIDAD	DIMENSION	TOTAL	GRAFICO #
VESTIDOR	1,00	-	1,00	ANEXO # 1
TOTAL			1,00	

RESUMEN DE PLANILLA AL 100%					
DESCRIPCION	CONTRATADO	ANTERIOR	ACTUAL	ACUMULADO	UNIDAD
DUCHAS CON MEZCLADORA (CON ACCESORIOS)	1,00	-	1,00	1,00	u



 CONTRATISTA



 FISCALIZACIÓN

BIEN AUTONOMO DESCENTRALIZADO DE PASTAZA
PROVINCIA DEL PASTAZA

" CONSTRUCCIÓN DE LOS HANGARES DEL GOBIERNO AUTÓNOMO DESCENTRALIZADO PROVINCIAL DE PASTAZA (GADPPZ) I ETAPA, PARROQUIA FÁTIMA, CANTÓN Y PROVINCIA DE PASTAZA "



ANEXO: 1

RUBRO	277
DESCRIPCION	DUCHAS CON MEZCLADORA (CON ACCESORIOS)
UNIDAD	U
PERIODO	1 DE JUNIO 2021 A 30 DE JUNIO 2021

UBICACION - NAVE DE DESECHOS

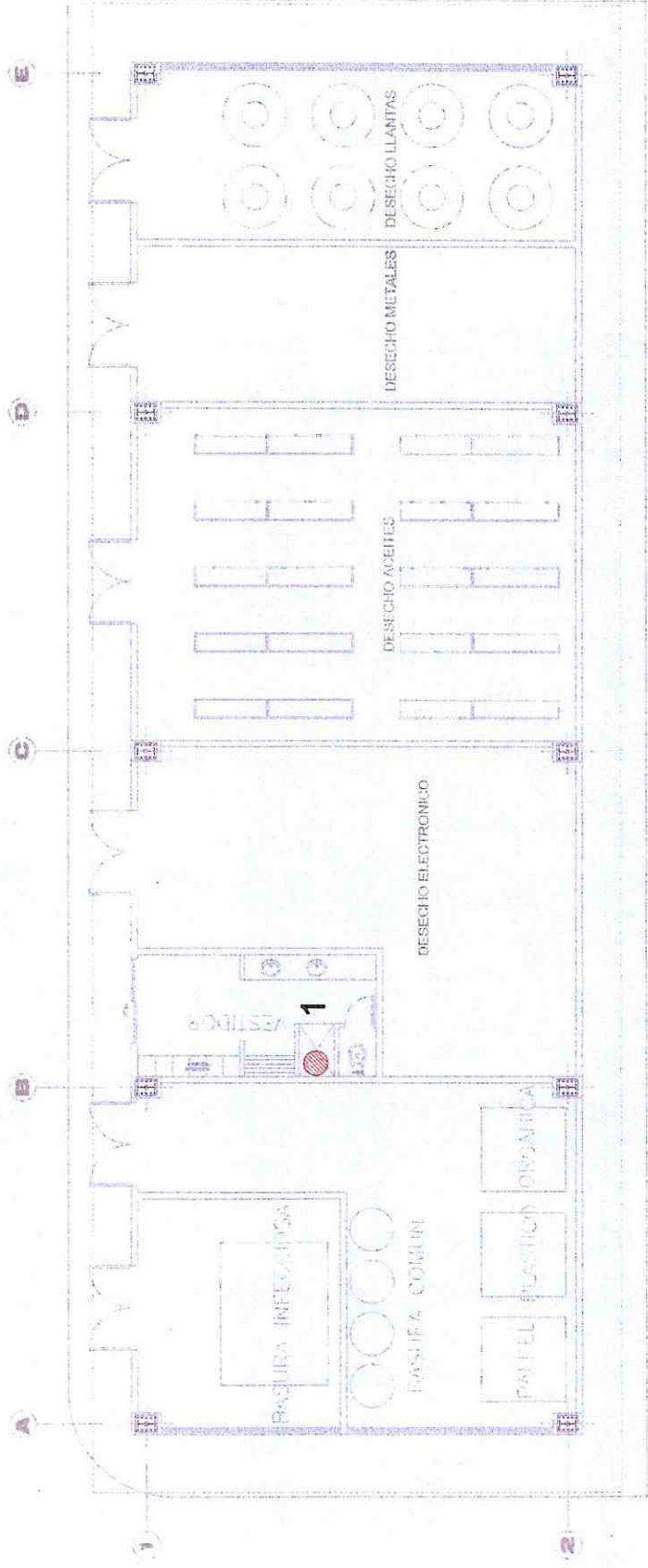
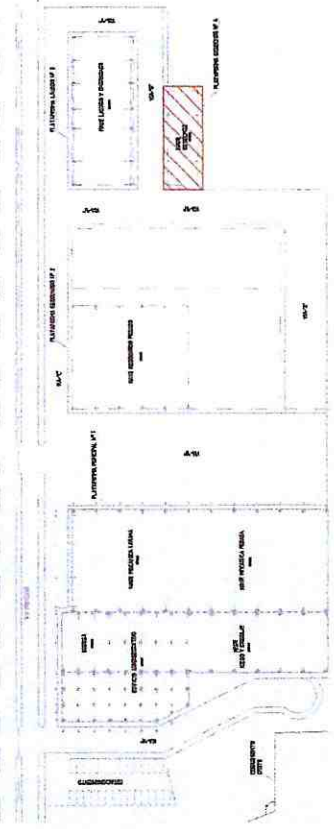

PLANTA ARQUITECTONICA - DUCHAS CON MEZCLADORA

CONTRATISTA

FISCALIZACIÓN

GOBIERNO AUTÓNOMO DESCENTRALIZADO DE LA PROVINCIA DEL PASTAZA

PROYECTO " CONSTRUCCIÓN DE LOS HANGARES DEL GOBIERNO AUTÓNOMO DESCENTRALIZADO PROVINCIAL DE PASTAZA (GADPPz) I ETAPA, PARROQUIA FÁTIMA, CANTÓN Y PROVINCIA DE PLANILLA DE AVANCE DE OBRA No. 23

RUBRO N° RN-4 ANEXO 1
 DESCRIPCIÓN: ACERAS DE H.S. F'C=180KG/CM2 E=7CM, ESCOBILLADA.
 UNIDAD: M2
 PERIODO: 01-jun 30-jun



PAG. 1 DE 1

ACERAS DE H.S. F'C=180KG/CM2 E=7CM, ESCOBILLADA.					
ACERA PORTERIOR DE LA VIA A Y MURO TALUD					
DESCRIPCION	LARGO (X)	AREA (M2)	ANCHO (Y)	No.	TOTAL
ACERAS INTERNAS		173,84		1	173,84
DESCUENTO TAPAS	0,48		0,3	-13	-1,87
SUBTOTAL					171,97
TOTAL					171,97

RESUMEN DE PLANILLA AL 100%					
DESCRIPCION	CONTRATADO	ANTERIOR	ACTUAL	ACUMULADO	UNIDAD
ACERAS DE H.S. F'C=180KG/CM2 E=7CM, ESCOBILLADA.	3.878,20	2.616,27	171,97	2.788,24	M2

 CONTRATISTA

 FISCALIZACIÓN

GOBIERNO AUTÓNOMO DESCENTRALIZADO DE PASTAZA
PROVINCIA DEL PASTAZA

" CONSTRUCCIÓN DE LOS HANGARES DEL GOBIERNO AUTÓNOMO DESCENTRALIZADO PROVINCIAL DE PASTAZA (GADPPz) I ETAPA, PARROQUIA FÁTIMA, CANTÓN Y PROVINCIA DE PASTAZA "

PROYECTO:

RUBRO	RN - 4
DESCRIPCION	ACERAS DE H.S. F'C=180KG/CM2 E=7CM, ESCOBILLADA.
UNIDAD	m ²
PERIODO	1 DE JUNIO 2021 A 30 DE JUNIO 2021

ANEXO: 1

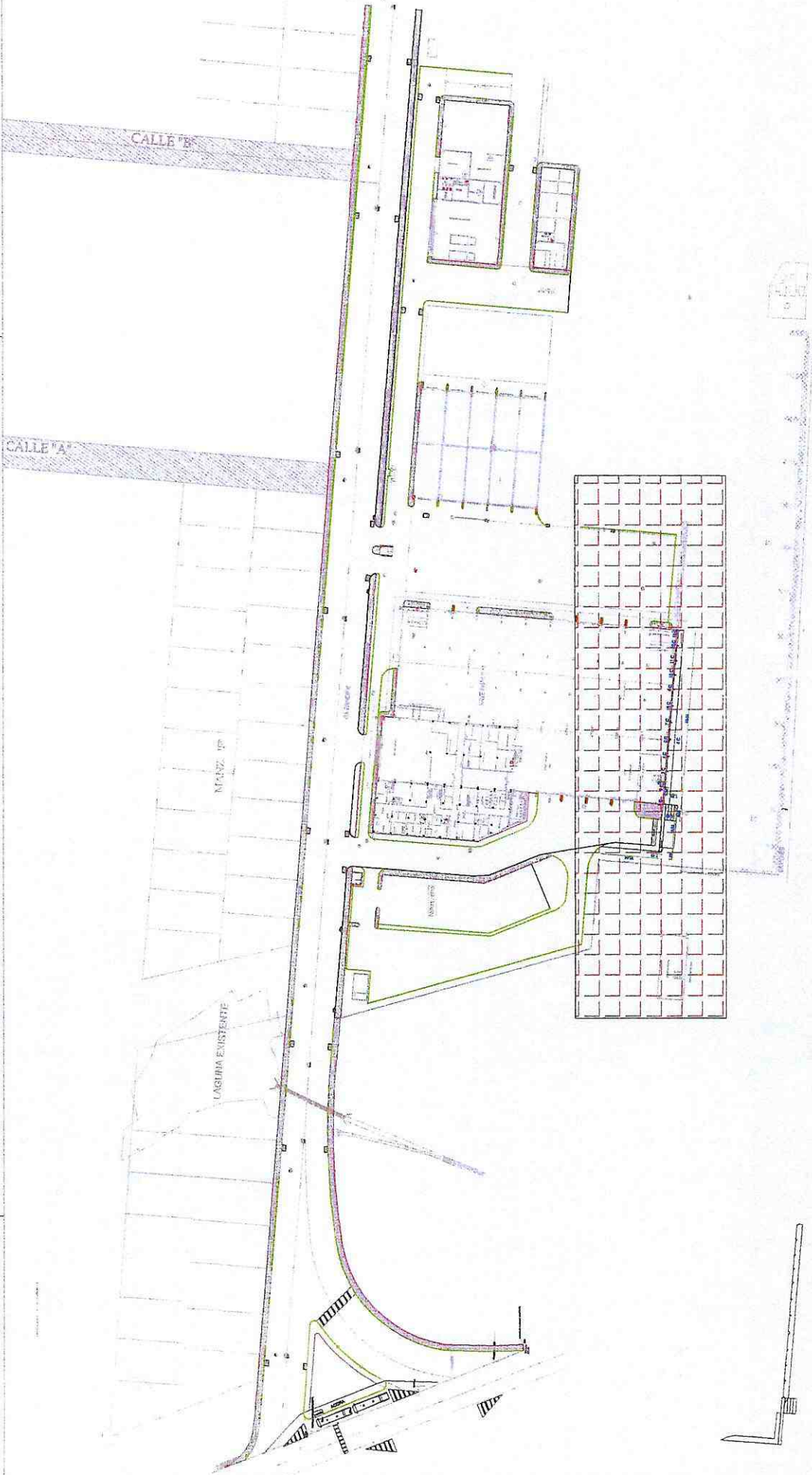

UBICACION - ACERAS EN VIA PRINCIPAL Y ACERAS EN VIAS INTERNAS

[Signature]
FISCALIZACIÓN

[Signature]
CONTRATISTA

**BIENIO AUTÓNOMO DESCENTRALIZADO DE
PROVINCIA DEL PASTAZA**

PROYECTO: "CONSTRUCCIÓN DE LOS HANGARES DEL GOBIERNO AUTÓNOMO DESCENTRALIZADO PROVINCIAL DE PASTAZA
(GADPPPZ) I ETAPA, PARROQUIA FÁTIMA, CANTÓN Y PROVINCIA DE PASTAZA "

RUBRO	RN - 4	ANEXO: 2
DESCRIPCIÓN	ACERAS DE H.S. F'C=180KG/CM2 E=7CM, ESCOBILLADA.	
UNIDAD	m ²	
PERIODO	1 DE JUNIO 2021 A 30 DE JUNIO 2021	



**PLANTA DE CAJAS DE REVISIÓN SANITARIO PLUVIAL EN VIA
PRINCIPAL**

CONTRATISTA  FISCALIZACIÓN 

G **BIERNO AUTONOMO DESCENTRALIZADO DE**
PROVINCIA DEL PASTAZA

" CONSTRUCCIÓN DE LOS HANGARES DEL GOBIERNO AUTÓNOMO DESCENTRALIZADO PROVINCIAL DE PASTAZA
 (GADPPZ) I ETAPA, PARROQUIA FÁTIMA, CANTÓN Y PROVINCIA DE PASTAZA "

PROYECTO:	
RUBRO	RN-7
DESCRIPCION	SUMINISTRO E INSTALACIÓN DE MOTOR ELÉCTRICO DE 500KG EN PUERTA DE INGRESO DE CERRAMIENTO
UNIDAD	U
PERIODO	1 DE JUNIO 2021 A 30 DE JUNIO 2021

ANEXO: 1

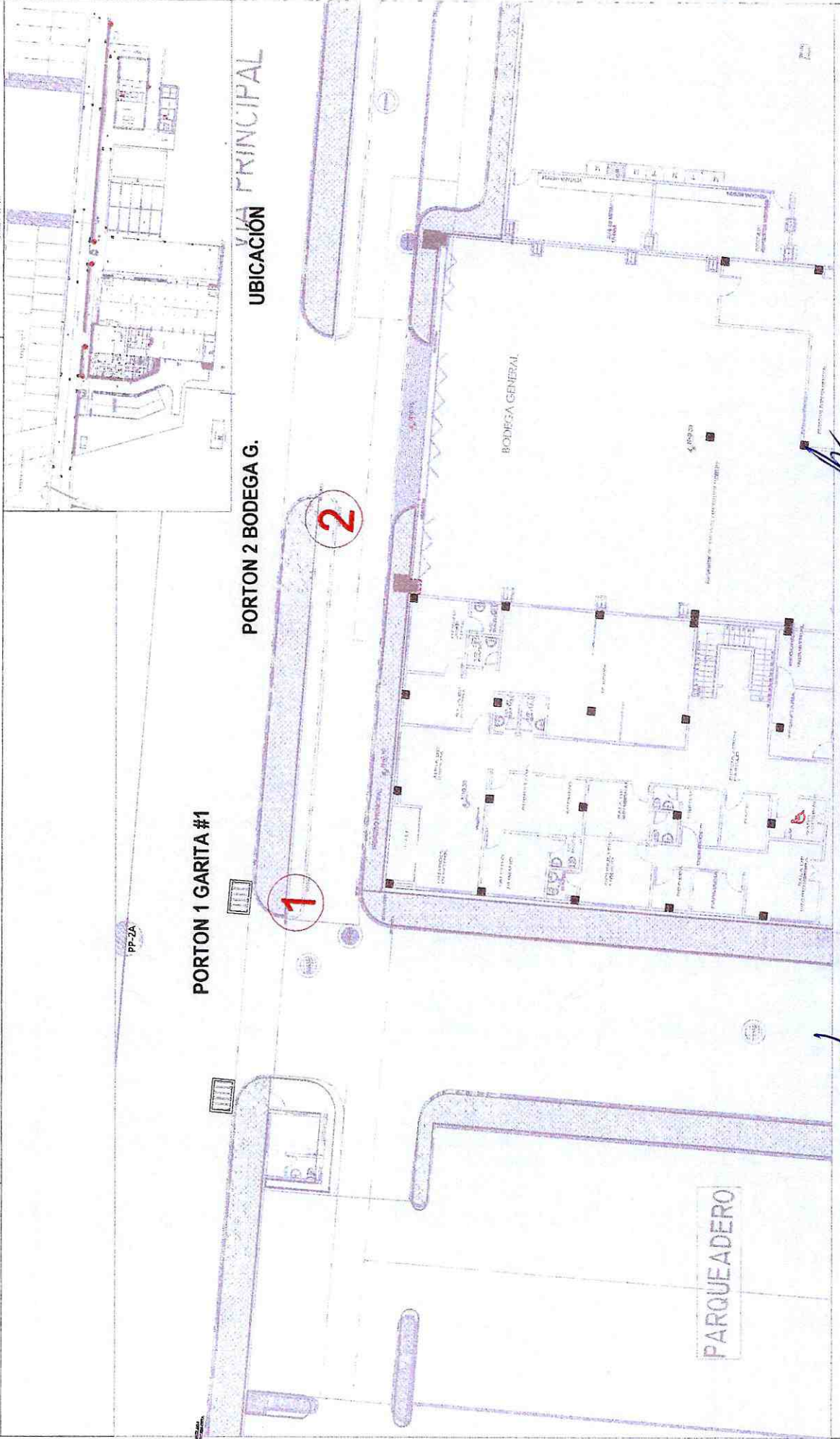

CONTRATISTA

UBICACION - GARITA #1

FISCALIZACION

Gobierno Autónomo Descentralizado de la Provincia del Pastaza

PROYECTO: "CONSTRUCCIÓN DE LOS HANGARES DEL GOBIERNO AUTÓNOMO DESCENTRALIZADO PROVINCIAL DE PASTAZA (GADPPz) (ETAPA, PARROQUIA FÁTIMA, CANTÓN Y PROVINCIA DE PASTAZA)"

RUBRO	RN-7	ANEXO: 2
DESCRIPCION	SUMINISTRO E INSTALACIÓN DE MOTOR ELÉCTRICO DE 500KG EN PUERTA DE INGRESO DE CERRAMIENTO	
UNIDAD	U	
PERIODO	1 DE JUNIO 2021 A 30 DE JUNIO 2021	

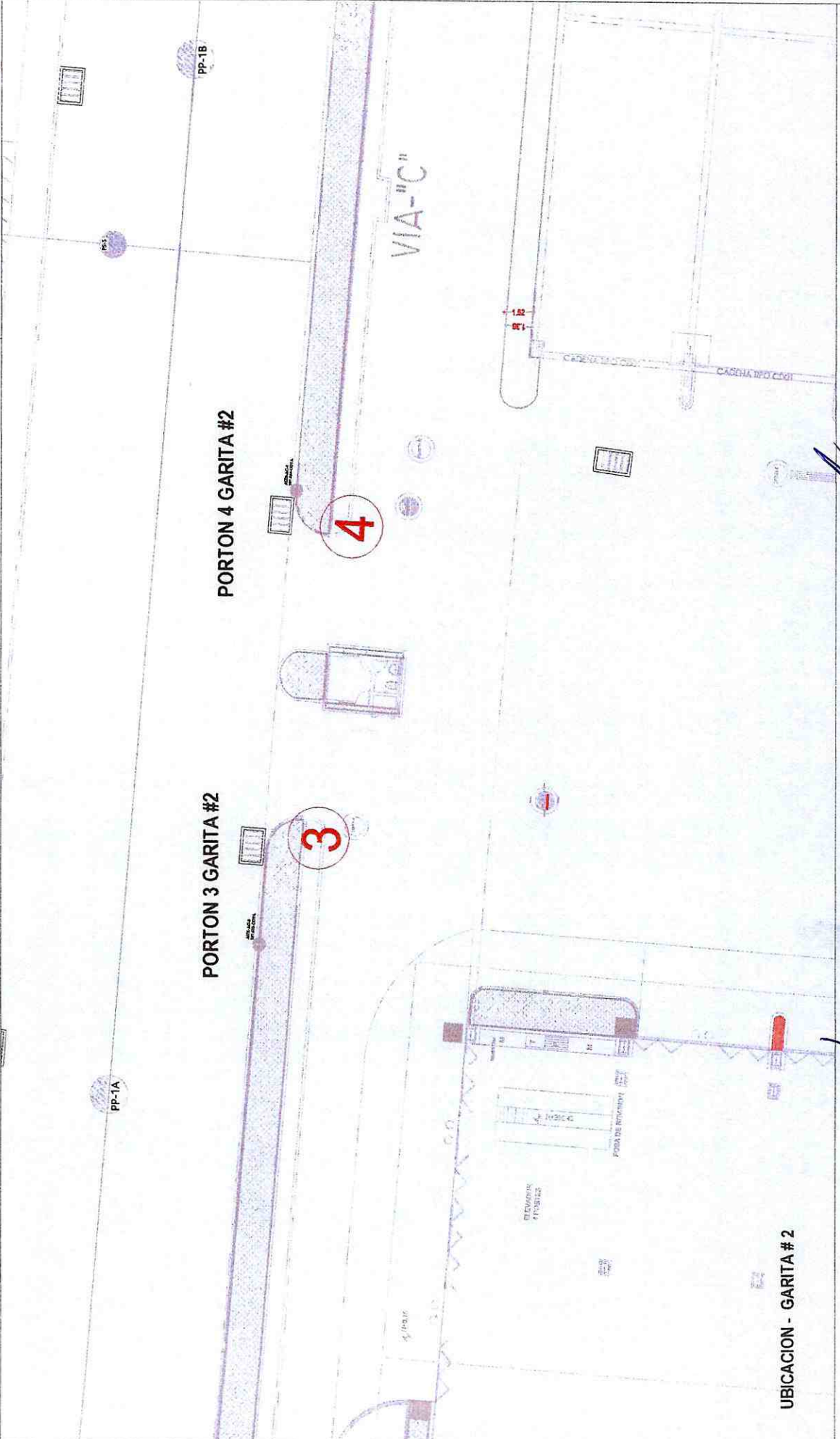

UBICACION - GARITA # 2

CONTRATISTA

FISCALIZACIÓN

GOBIERNO AUTÓNOMO DESCENTRALIZADO DE LA PROVINCIA DEL PASTAZA

PROYECTO " CONSTRUCCIÓN DE LOS HANGARES DEL GOBIERNO AUTÓNOMO DESCENTRALIZADO PROVINCIAL DE PASTAZA (GADPPz) I ETAPA, PARROQUIA FÁTIMA, CANTÓN Y PROVINCIA DE PASTAZA "

PLANILLA DE AVANCE DE OBRA No. 23

RUBRO N° RN-9 ANEXO 1
 DESCRIPCIÓN: TOPES PARA ESTACIONAMIENTO H.S = 180 KG/CM2 . INCLUYE PINTURA REFLECTIVA
 UNIDAD: U
 PERIODO: 01-jun 30-jun



TOPES PARA ESTACIONAMIENTO H.S = 180 KG/CM2 . INCLUYE PINTURA REFLECTIVA						
PORTONES DE INGRESO						
DESCRIPCION	LARGO (X)	ANCHO (Y)	ALTO (Z)	No.	SUBTOTAL	TOTAL
PORTON DE INGRESO				88,00	88,00	88,00
SUBTOTAL					88,00	

RESUMEN DE PLANILLA AL 100%					
DESCRIPCION	CONTRATADO	ANTERIOR	ACTUAL	ACUMULADO	UNIDAD
SUMINISTRO E INSTALACIÓN DE MOTOR ELÉCTRICO DE 500KG EN PUERTA DE INGRESO DE CERRAMIENTO	88,00	-	88,00	88,00	U



 CONTRATISTA



 FISCALIZACIÓN

G BIENIO AUTÓNOMO DESCENTRALIZADO DE LA
PROVINCIA DEL PASTAZA

" CONSTRUCCIÓN DE LOS HANGARES DEL GOBIERNO AUTÓNOMO DESCENTRALIZADO PROVINCIAL DE PASTAZA
 (GADPP2) | ETAPA, PARROQUIA FÁTIMA, CANTÓN Y PROVINCIA DE PASTAZA "

PROYECTO:	RN-9	ANEXO: 1
RUBRO	TOPES PARA ESTACIONAMIENTO H.S = 180 KG/CM2 . INCLUYE PINTURA REFLECTIVA	
DESCRIPCION	U	
UNIDAD		
PERIODO	1 DE JUNIO 2021 A 30 DE JUNIO 2021	

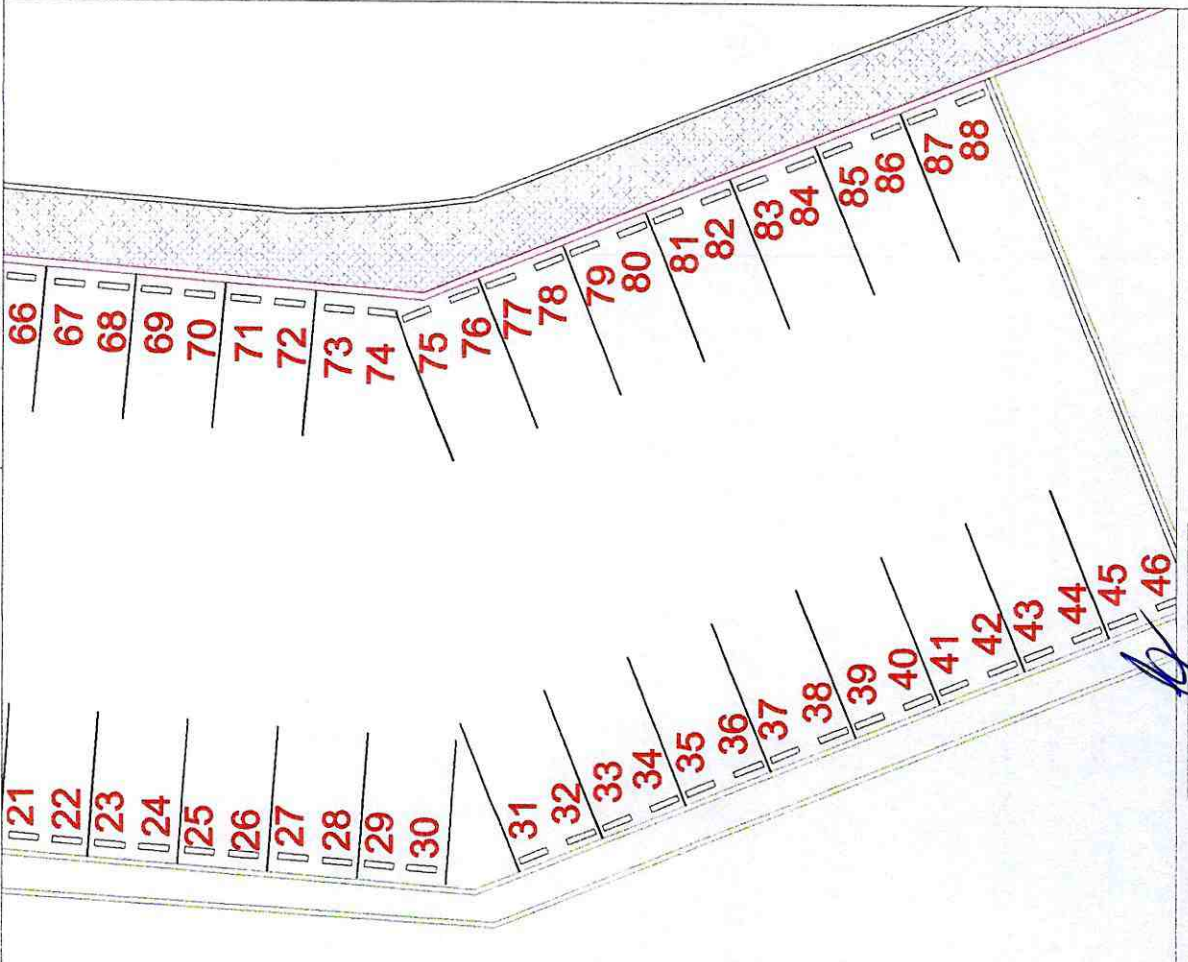
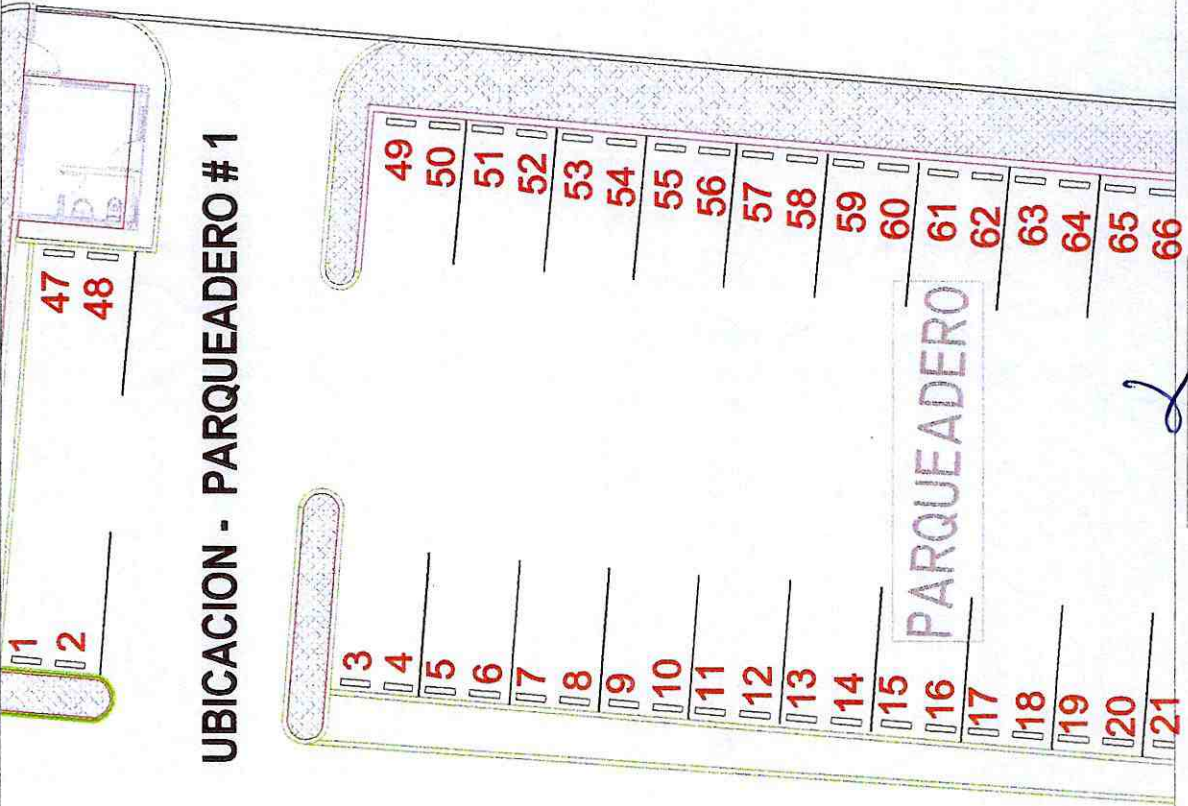
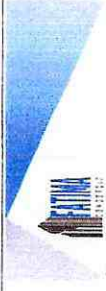

CONTRATISTA

REALIZACIÓN

GOBIERNO AUTÓNOMO DESCENTRALIZADO DE LA PROVINCIA DEL PASTAZA

PROYECTO " CONSTRUCCIÓN DE LOS HANGARES DEL GOBIERNO AUTÓNOMO DESCENTRALIZADO PROVINCIAL DE PASTAZA (GADPPz) I ETAPA, PARROQUIA FÁTIMA, CANTÓN Y PROVINCIA DE PASTAZA "

PLANILLA DE AVANCE DE OBRA No. 23

RUBRO N° RN-11
 DESCRIPCIÓN: PLANTAS ORNAMENTALES
 UNIDAD: ML
 PERIODO: 01-jun 30-jun

ANEXO 1



PLANTAS ORNAMENTALES						
JADINERAS						
DESCRIPCION	LARGO (X)	ANCHO (Y)	ALTO (Z)	No.	SUBTOTAL	TOTAL
JADINERA 1	11,74			1,00	11,74	11,74
JADINERA 2	14,54			1,00	14,54	14,54
JADINERA 3	7,60			1,00	7,60	7,60
JADINERA 4	10,70			1,00	10,70	10,70
JADINERA 5	72,85			1,00	72,85	72,85
JADINERA 6	26,07			1,00	26,07	26,07
JADINERA 7	11,84			1,00	11,84	11,84
JADINERA 8	11,77			1,00	11,77	11,77
JADINERA 9	9,13			1,00	9,13	9,13
JADINERA 10	8,62			1,00	8,62	8,62
JADINERA 11	6,40			1,00	6,40	6,40
JADINERA 12	4,95			1,00	4,95	4,95
JADINERA 13	21,74			1,00	21,74	21,74
JADINERA 14	35,93			1,00	35,93	35,93
JADINERA 15	15,26			1,00	15,26	15,26
JADINERA 16	6,69			1,00	6,69	6,69
JADINERA 17	24,21			1,00	24,21	24,21
JADINERA 18	52,15			1,00	52,15	52,15
JADINERA 19	10,53			1,00	10,53	10,53
JADINERA 20	4,45			1,00	4,45	4,45
JADINERA 21	167,03			1,00	167,03	167,03
					SUBTOTAL	534,20

RESUMEN DE PLANILLA AL 100%					
DESCRIPCION	CONTRATADO	ANTERIOR	ACTUAL	ACUMULADO	UNIDAD
PLANTAS ORNAMENTALES	26,00	-	26,00	26,00	ML

RESUMEN DE PLANILLA DE INCREMENTOS						
DESCRIPCION	CONTRATADO	ANTERIOR	ACTUAL	INCR. ANT.	INCR. ACT.	UNIDAD
PLANTAS ORNAMENTALES	26,00	0,00			508,20	ML

 CONTRATISTA

 FISCALIZACIÓN

G BIERNO AUTONOMO DESCENTRALIZADO DE LA
PROVINCIA DEL PASTAZA

" CONSTRUCCIÓN DE LOS HANGARES DEL GOBIERNO AUTÓNOMO DESCENTRALIZADO PROVINCIAL DE PASTAZA
 (GADPP2) | ETAPA, PARROQUIA FÁTIMA, CANTÓN Y PROVINCIA DE PASTAZA "

PROYECTO:	ANEXO: 1		
RUBRO	RN - 11	DESCRIPCION	PLANTAS ORNAMENTALES
UNIDAD	ML	PERIODO	1 DE JUNIO 2021 A 30 DE JUNIO 2021

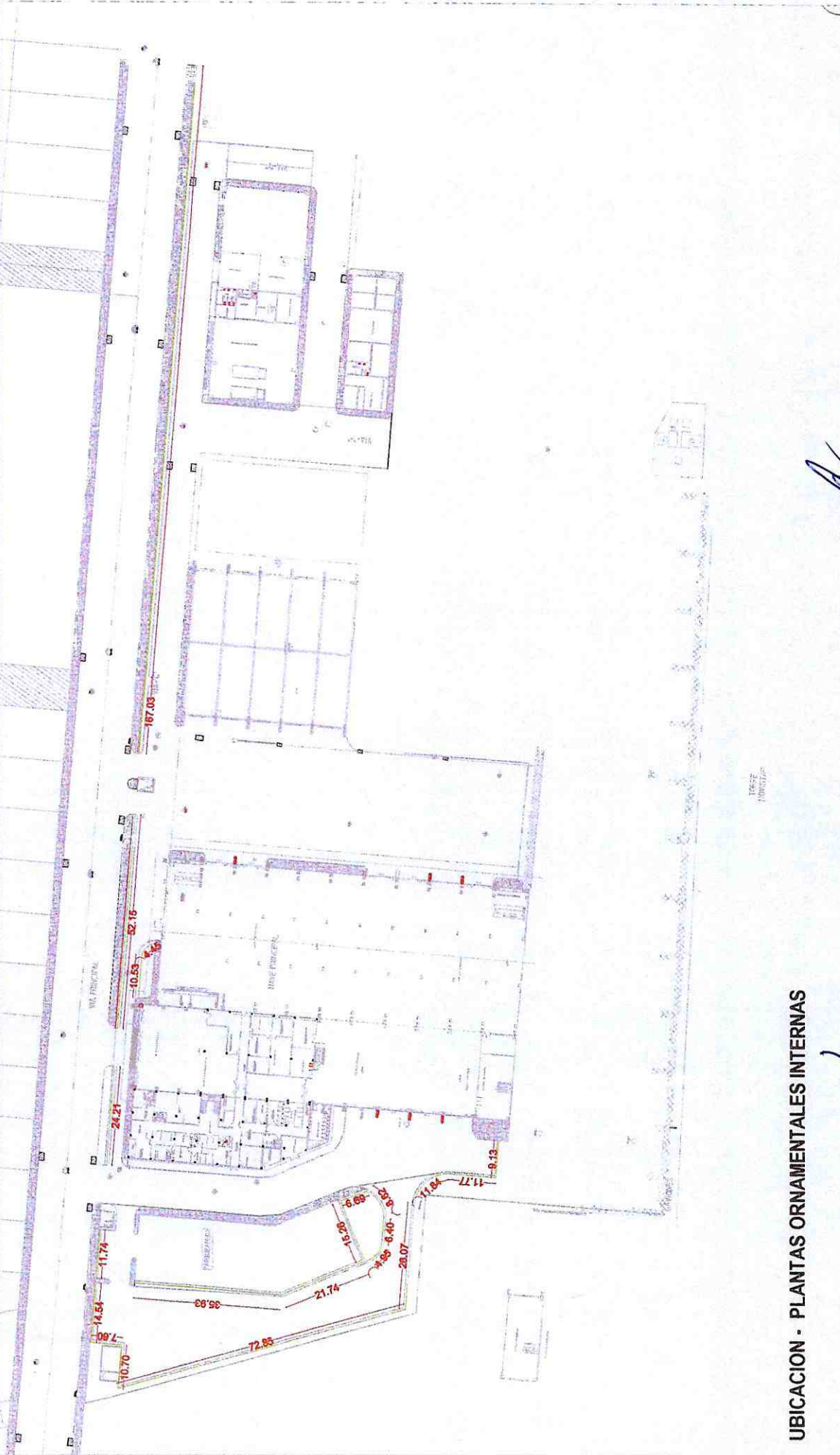

UBICACION - PLANTAS ORNAMENTALES INTERNAS

CONTRATISTA

FISCALIZACIÓN

G BIENIO AUTÓNOMO DESCENTRALIZADO DE LA
PROVINCIA DEL PASTAZA

" CONSTRUCCIÓN DE LOS HANGARES DEL GOBIERNO AUTÓNOMO DESCENTRALIZADO PROVINCIAL DE PASTAZA
 (GADPP2) I ETAPA, PARROQUIA FÁTIMA, CANTÓN Y PROVINCIA DE PASTAZA "

RUBRO	RN - 11
DESCRIPCION	PLANTAS ORNAMENTALES
UNIDAD	ML
PERIODO	1 DE JUNIO 2021 A 30 DE JUNIO 2021

ANEXO: 2

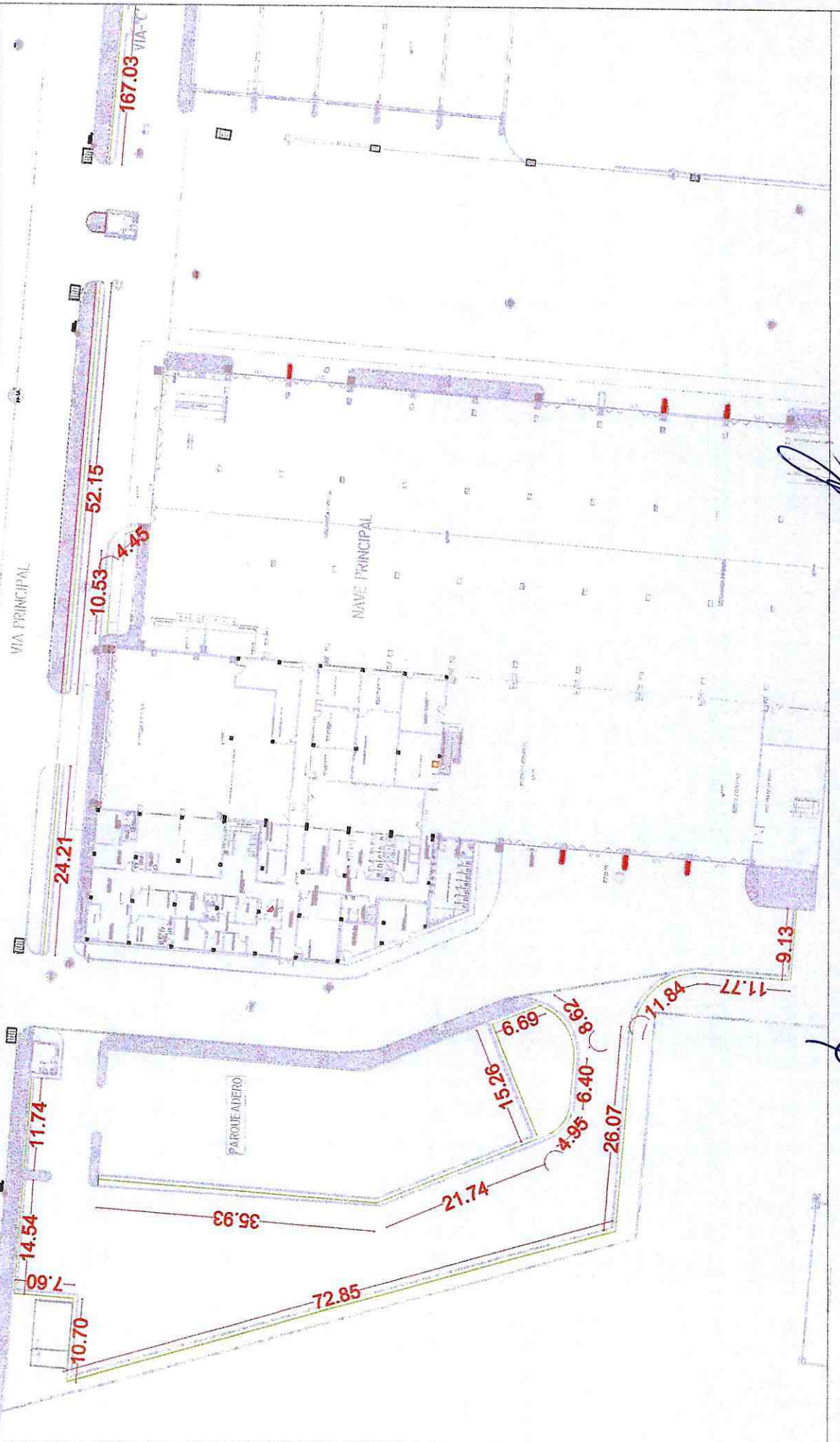

CONTRATISTA

FISCALIZACIÓN

G **BIERNO AUTONOMO DESCENTRALIZADO DE LA**
PROVINCIA DEL PASTAZA

" CONSTRUCCIÓN DE LOS HANGARES DEL GOBIERNO AUTÓNOMO DESCENTRALIZADO PROVINCIAL DE PASTAZA
(GADPPP2) I ETAPA, PARROQUIA FÁTIMA, CANTÓN Y PROVINCIA DE PASTAZA "

PROYECTO:	ANEXO: 3		
RUBRO	RN - 11	DESCRIPCION	PLANTAS ORNAMENTALES
UNIDAD	ML	PERIODO	1 DE JUNIO 2021 A 30 DE JUNIO 2021

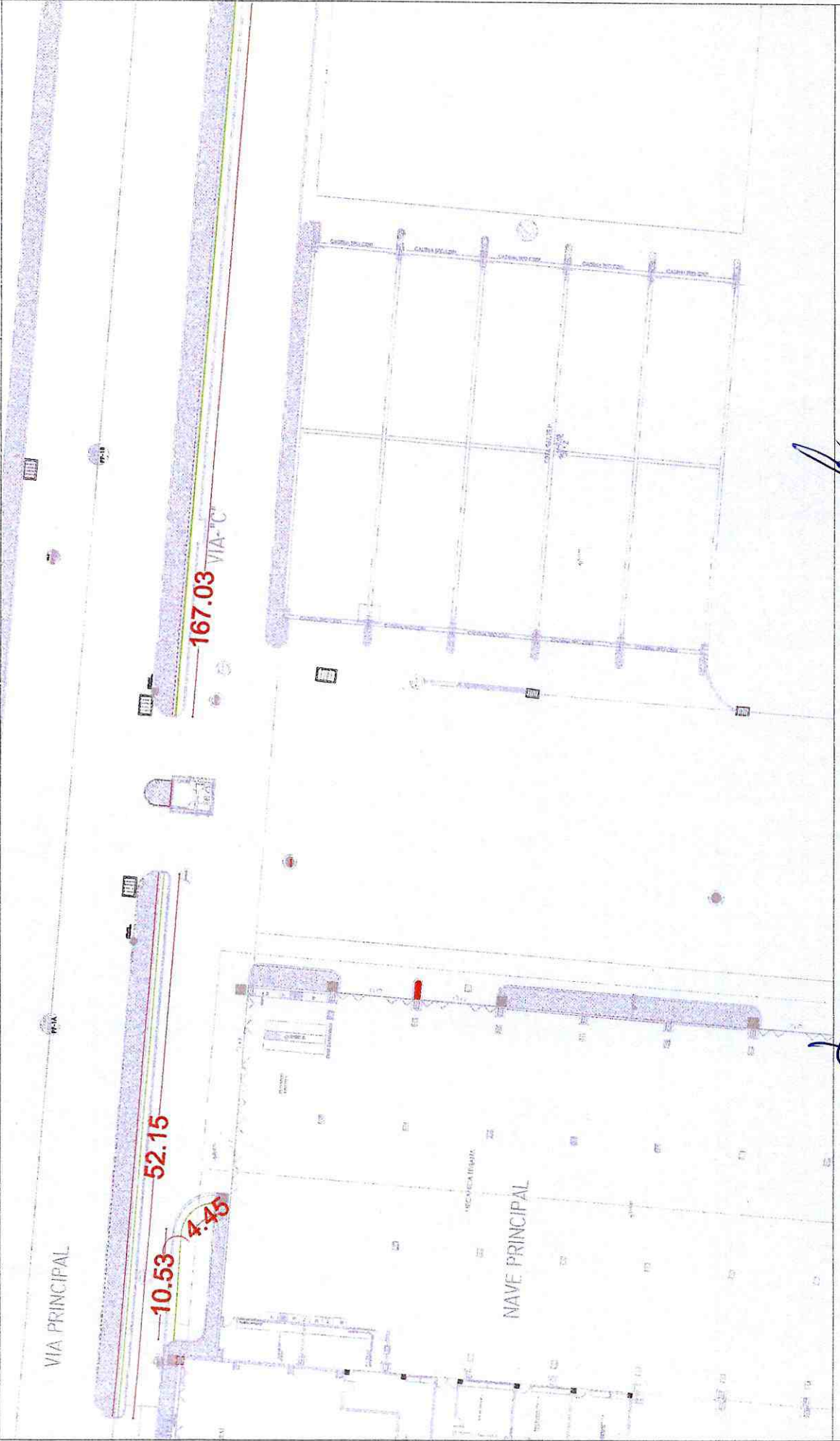

FISCALIZACIÓN

CONTRATISTA

**BIERNO AUTONOMO DESCENTRALIZADO DE
PROVINCIA DEL PASTAZA**

" CONSTRUCCIÓN DE LOS HANGARES DEL GOBIERNO AUTÓNOMO DESCENTRALIZADO PROVINCIAL DE PASTAZA
(GADPPz) I ETAPA, PARROQUIA FÁTIMA, CANTÓN Y PROVINCIA DE PASTAZA "

RUBRO	RN - 12	ANEJO: 1
DESCRIPCION	PALMERAS BOTELLAS ENANAS	
UNIDAD	U	
PERIODO	1 DE JUNIO 2021 A 30 DE JUNIO 2021	



UBICACION - PALMERAS BOTELLAS ENANAS

[Signature]
CONTRATISTA

[Signature]
EJECUTIVO

BIEN GOBIERNO AUTÓNOMO DESCENTRALIZADO DE PASTAZA
 PROVINCIA DEL PASTAZA

"CONSTRUCCIÓN DE LOS HANGARES DEL GOBIERNO AUTÓNOMO DESCENTRALIZADO PROVINCIAL DE PASTAZA (GADPPz) (ETAPA, PARROQUIA FÁTIMA, CANTÓN Y PROVINCIA DE PASTAZA)"

ANEXO: 1

RUBRO	RN - 17
DESCRIPCION	DUCHA ELÉCTRICA 110 V
UNIDAD	U
PERIODO	1 DE JUNIO 2021 A 30 DE JUNIO 2021



UBICACION - DUCHA ELÉCTRICA 110 V

[Signature]
 CONTRATISTA

[Signature]
 FISCALIZACIÓN

BIEN GOBIERNO AUTONOMO DESCENTRALIZADO DE PASTAZA
PROVINCIA DEL PASTAZA

" CONSTRUCCIÓN DE LOS HANGARES DEL GOBIERNO AUTÓNOMO DESCENTRALIZADO PROVINCIAL DE PASTAZA (GADPPz) I ETAPA, PARROQUIA FÁTIMA, CANTÓN Y PROVINCIA DE PASTAZA "

ANEXO: 1

RUBRO: RN - 18
 DESCRIPCIÓN: LLAVE DE DUCHA
 UNIDAD: U
 PERIODO: 1 DE JUNIO 2021 A 30 DE JUNIO 2021



UBICACION - DUCHA ELÉCTRICA 110 V

[Signature]
 CONTRATISTA

[Signature]
 FISCALIZACIÓN

GOBIERNO AUTÓNOMO DESCENTRALIZADO DE LA PROVINCIA DEL PASTAZA

PROYECTO " CONSTRUCCIÓN DE LOS HANGARES DEL GOBIERNO AUTÓNOMO DESCENTRALIZADO PROVINCIAL DE PASTAZA (GADPPz) I ETAPA, PARROQUIA FÁTIMA, CANTÓN Y PROVINCIA DE PASTAZA "

PLANILLA DE AVANCE DE OBRA No. 23

RUBRO N° RN-19
 DESCRIPCIÓN: REJILLAS DE PISO 50 MM
 UNIDAD: U
 PERIODO: 01-jun 30-jun

ANEXO 1



REJILLAS DE PISO 50 MM						
BLOQUE ADM PB-PA - LAVADO - DESECHOS - GARITAS						
DESCRIPCION	LARGO (X)	ANCHO (Y)	ALTO (Z)	No.	SUBTOTAL	TOTAL
REJILLAS DE PISO						
BLOQUE ADM PB-PA	PB			27,00	27,00	27,00
	PA			15,00	15,00	15,00
GARITA 1-2				2,00	2,00	2,00
LAVADO				4,00	4,00	4,00
DESECHOS				1,00	1,00	1,00
REJILLAS DE PARED						
BLOQUE ADM PB-PA	PB			16,00	16,00	16,00
	PA			5,00	5,00	5,00
LAVADO				4,00	4,00	4,00
DESECHOS				1,00	1,00	1,00
					SUBTOTAL	75,00

RESUMEN DE PLANILLA AL 100%					
DESCRIPCION	CONTRATADO	ANTERIOR	ACTUAL	ACUMULADO	UNIDAD
REJILLAS DE PISO 50 MM	42,00	-	42,00	42,00	U

RESUMEN DE PLANILLA DE INCREMENTOS						
DESCRIPCION	CONTRATADO	ANTERIOR	ACTUAL	INCR. ANT.	INCR. ACT.	UNIDAD
REJILLAS DE PISO 50 MM	42,00	0,00			33,00	U



 CONTRATISTA



 ESCALIZACIÓN

**BIERNO AUTONOMO DESCENTRALIZADO DE PASTAZA
PROVINCIA DEL PASTAZA**

" CONSTRUCCIÓN DE LOS HANGARES DEL GOBIERNO AUTÓNOMO DESCENTRALIZADO PROVINCIAL DE PASTAZA
(GADPPz) I ETAPA, PARROQUIA FÁTIMA, CANTÓN Y PROVINCIA DE PASTAZA "

PROYECTO:

RUBRO	RN - 19
DESCRIPCION	REJILLAS DE PISO 50 MM
UNIDAD	U
PERIODO	1 DE JUNIO 2021 A 30 DE JUNIO 2021

ANEXO: 1

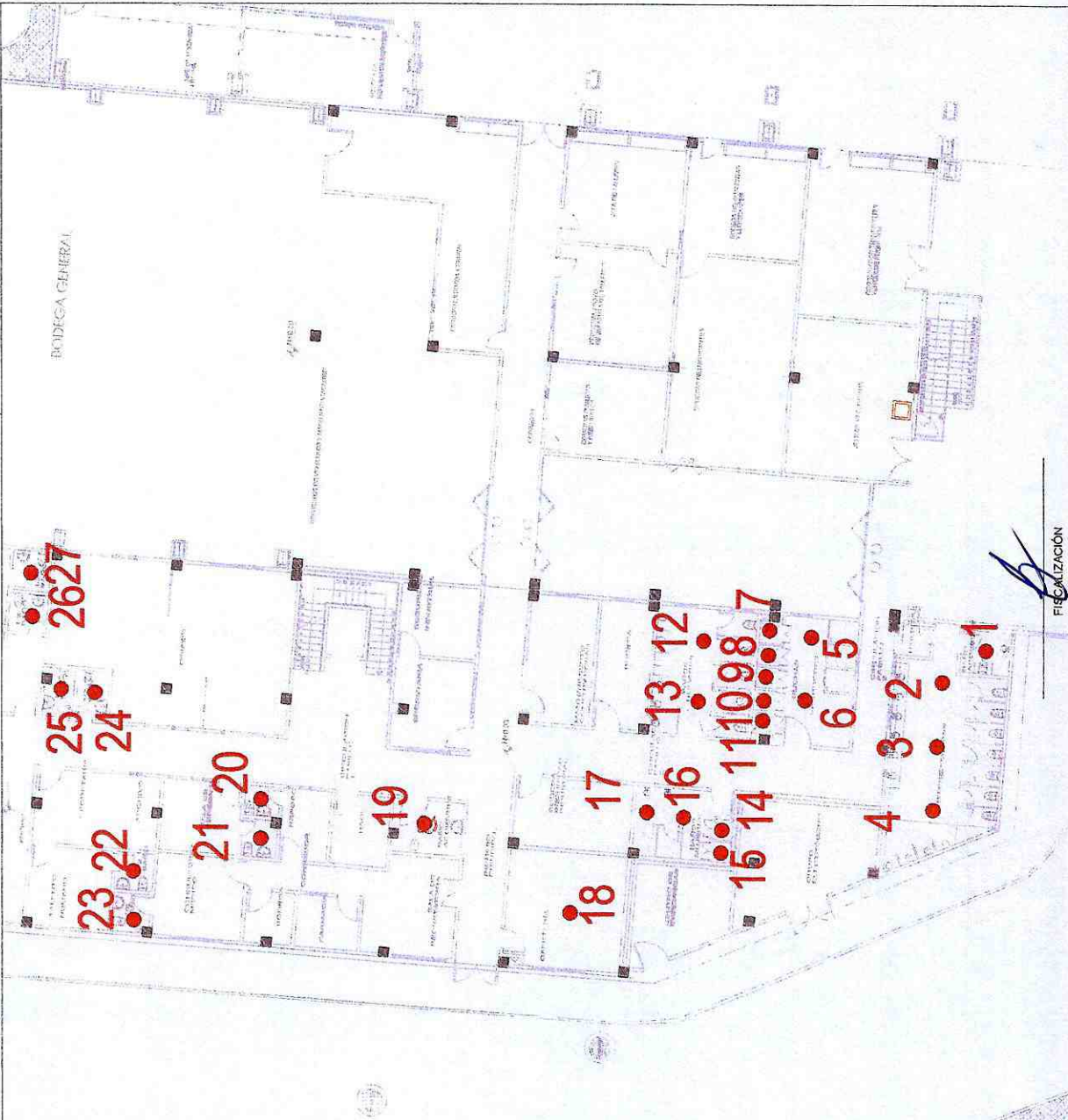

[Signature]
CONTRATISTA

[Signature]
FISCALIZACIÓN

**BIERNO AUTONOMO DESCENTRALIZADO DE
PROVINCIA DEL PASTAZA**

" CONSTRUCCIÓN DE LOS HANGARES DEL GOBIERNO AUTÓNOMO DESCENTRALIZADO PROVINCIAL DE PASTAZA
(GADPPZ) I ETAPA, PARROQUIA FÁTIMA, CANTÓN Y PROVINCIA DE PASTAZA "

ANEXO: 2

RN - 19
RÉJILLAS DE PISO 50 MM

U

1 DE JUNIO 2021 A 30 DE JUNIO 2021

PROYECTO:

RUBRO
DESCRIPCION

UNIDAD

PERIODO



**UBICACION - BLOQUE
ADMINISTRATIVO PA**

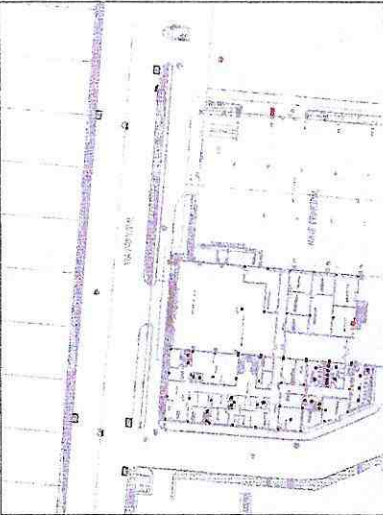
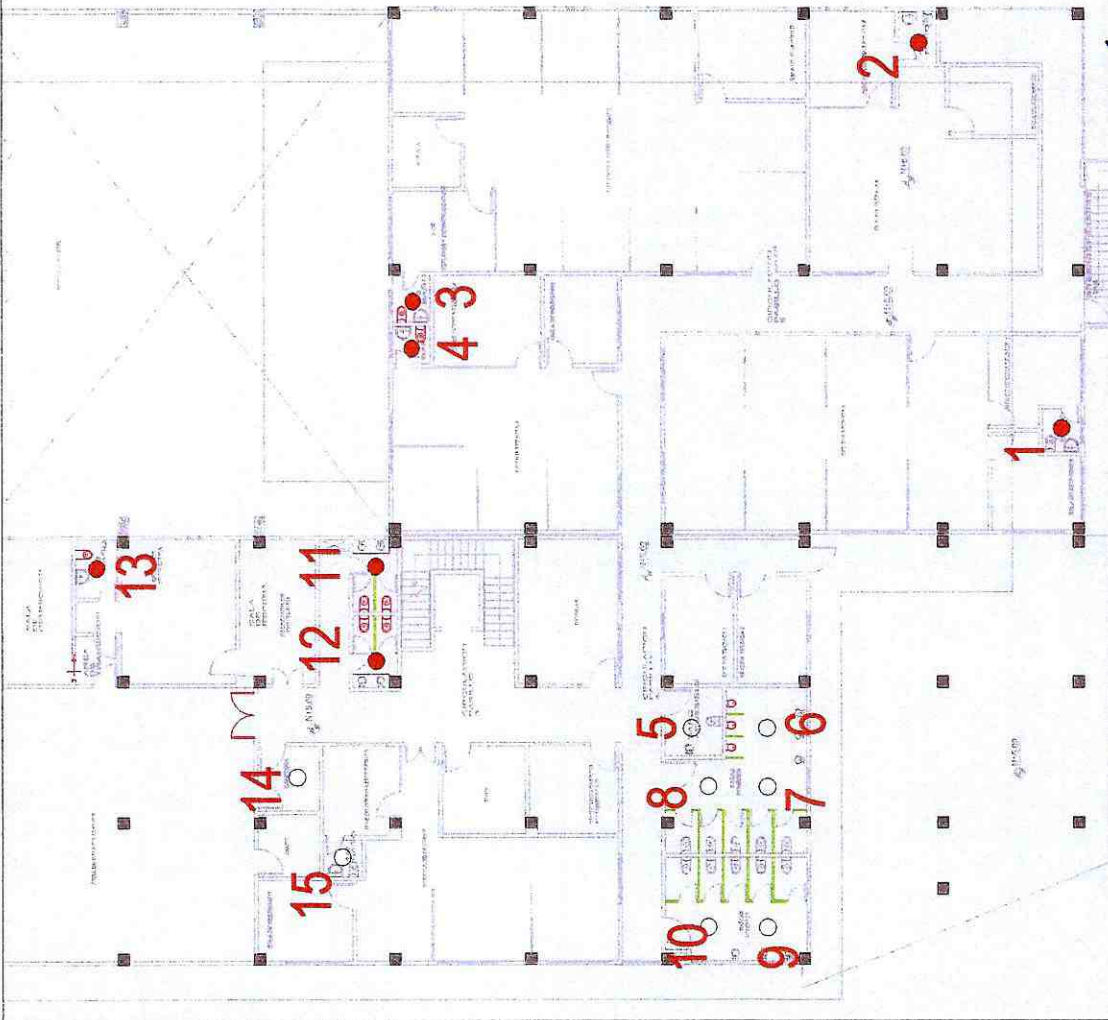

UBICACION - GARITA 1-2

CONTRATISTA

FISCALIZACIÓN

BIEN GOBIERNO AUTONOMO DESCENTRALIZADO DE PASTAZA
PROVINCIA DEL PASTAZA

PROYECTO: " CONSTRUCCIÓN DE LOS HANGARES DEL GOBIERNO AUTÓNOMO DESCENTRALIZADO PROVINCIAL DE PASTAZA (GADPPz) I ETAPA, PARROQUIA FÁTIMA, CANTÓN Y PROVINCIA DE PASTAZA "

RUBRO: RN - 19
 DESCRIPCIÓN: REJILLAS DE PISO 50 MM
 UNIDAD: U
 PERIODO: 1 DE JUNIO 2021 A 30 DE JUNIO 2021

ANEXO: 3

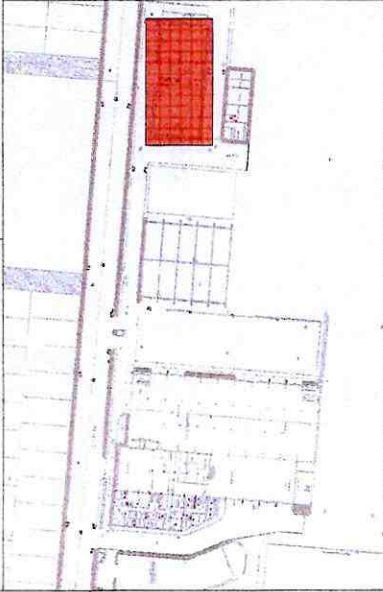

UBICACION - LAVADO ENGRASADO

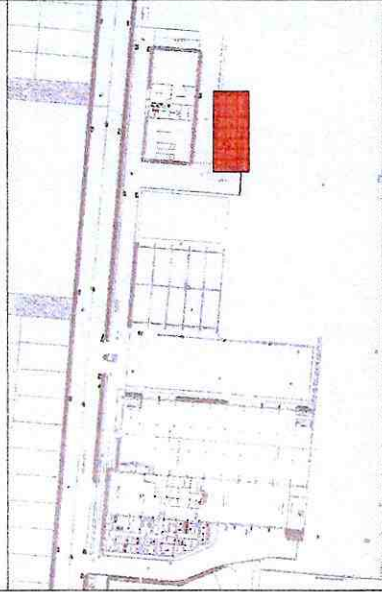
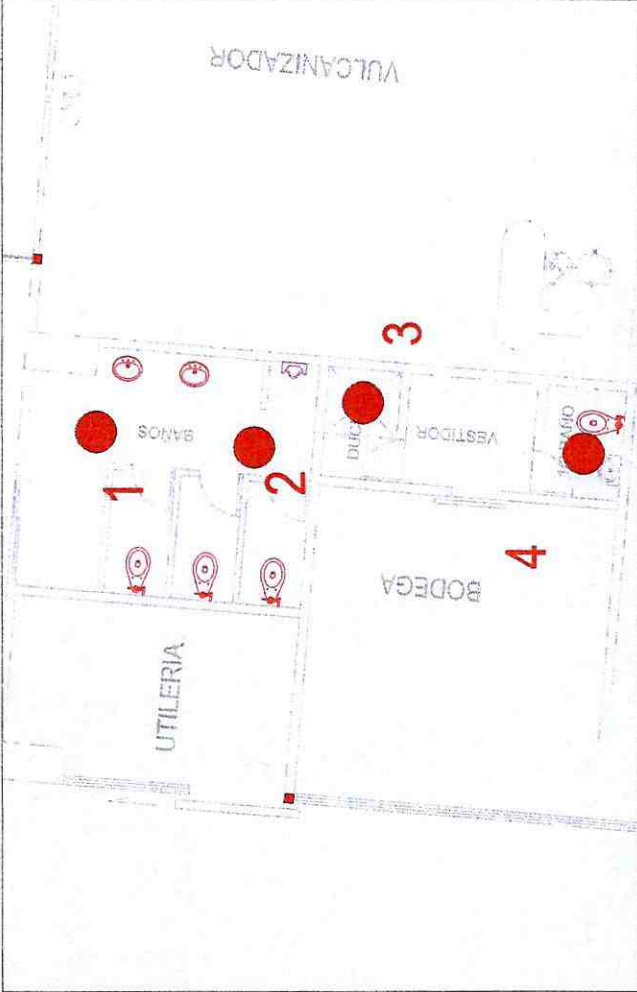

UBICACION - DESECHOS

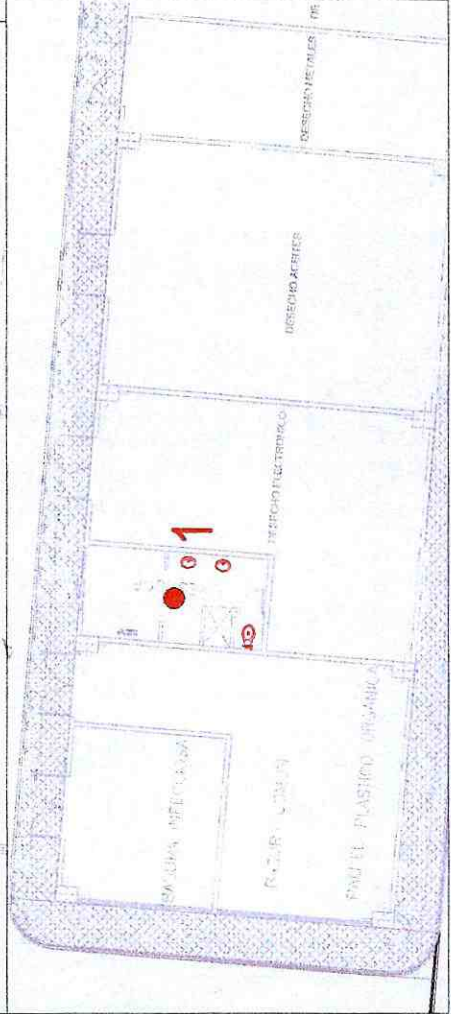

[Signature]
 CONTRATISTA

[Signature]
 FISCALIZACIÓN

BIENERNO AUTONOMO DESCENTRALIZADO DE PASTAZA
PROVINCIA DEL PASTAZA

PROYECTO: " CONSTRUCCIÓN DE LOS HANGARES DEL GOBIERNO AUTÓNOMO DESCENTRALIZADO PROVINCIAL DE PASTAZA (GADPPz) | ETAPA, PARROQUIA FÁTIMA, CANTÓN Y PROVINCIA DE PASTAZA "

RUBRO	RN - 19
DESCRIPCION	REJILLAS DE PISO 50 MM
UNIDAD	U
PERIODO	1 DE JUNIO 2021 A 30 DE JUNIO 2021

ANEXO: 4

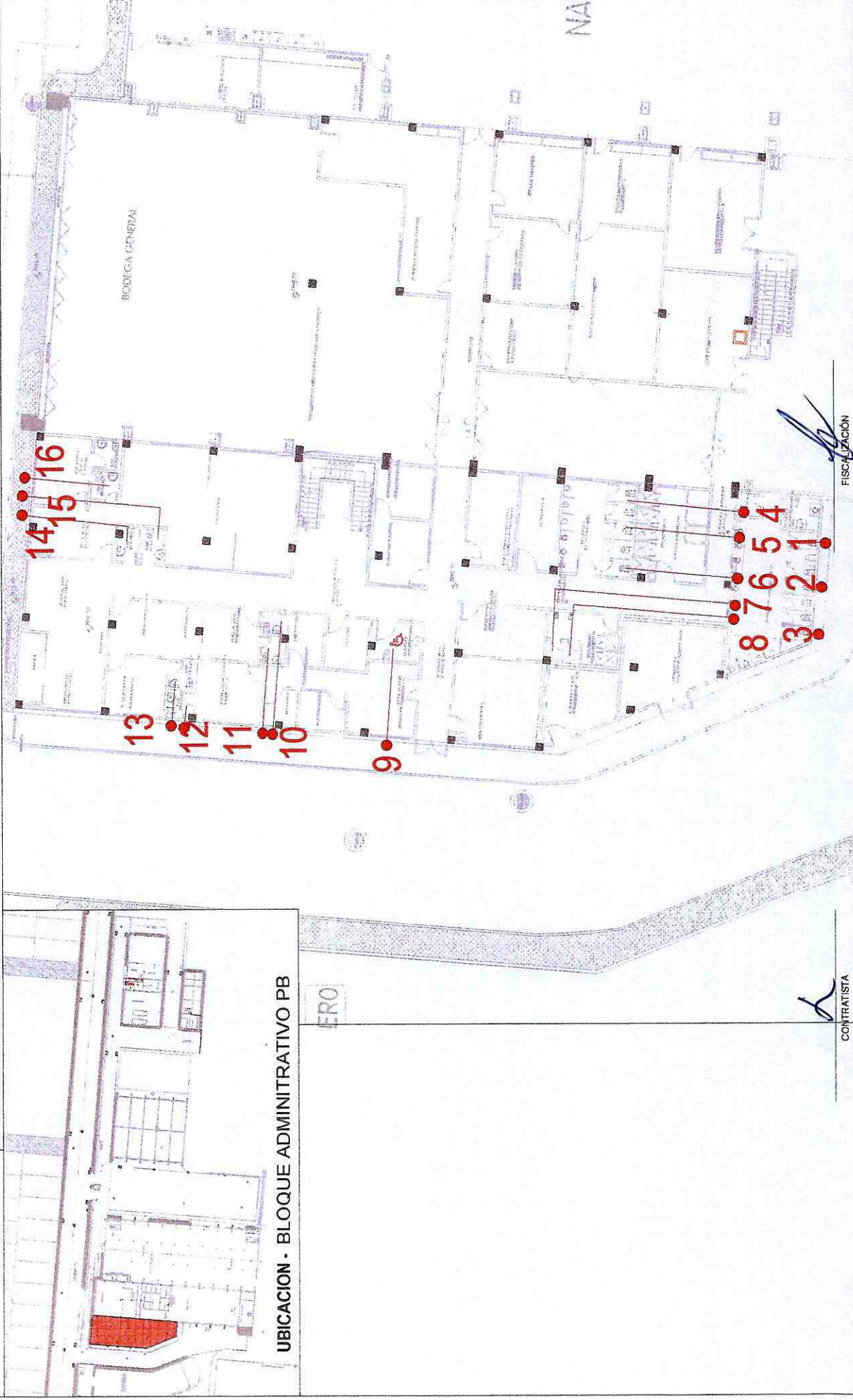

UBICACION - BLOQUE ADMINISTRATIVO PB

FISCALIZACIÓN

CONTRATISTA

**BIENIO AUTONOMO DESCENTRALIZADO DE LA
PROVINCIA DEL PASTAZA**

" CONSTRUCCIÓN DE LOS HANGARES DEL GOBIERNO AUTÓNOMO DESCENTRALIZADO PROVINCIAL DE PASTAZA
(GADPPz) I ETAPA, PARROQUIA FÁTIMA, CANTÓN Y PROVINCIA DE PASTAZA "



ANEXO: 5

RN - 19
REJILLAS DE PISO 50 MM
U

1 DE JUNIO 2021 A 30 DE JUNIO 2021

PROYECTO:

RUBRO
DESCRIPCION
UNIDAD
PERIODO

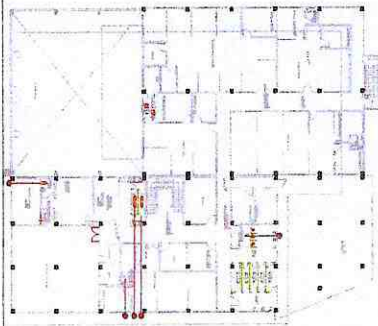

**UBICACION - BLOQUE
ADMINISTRATIVO PA**

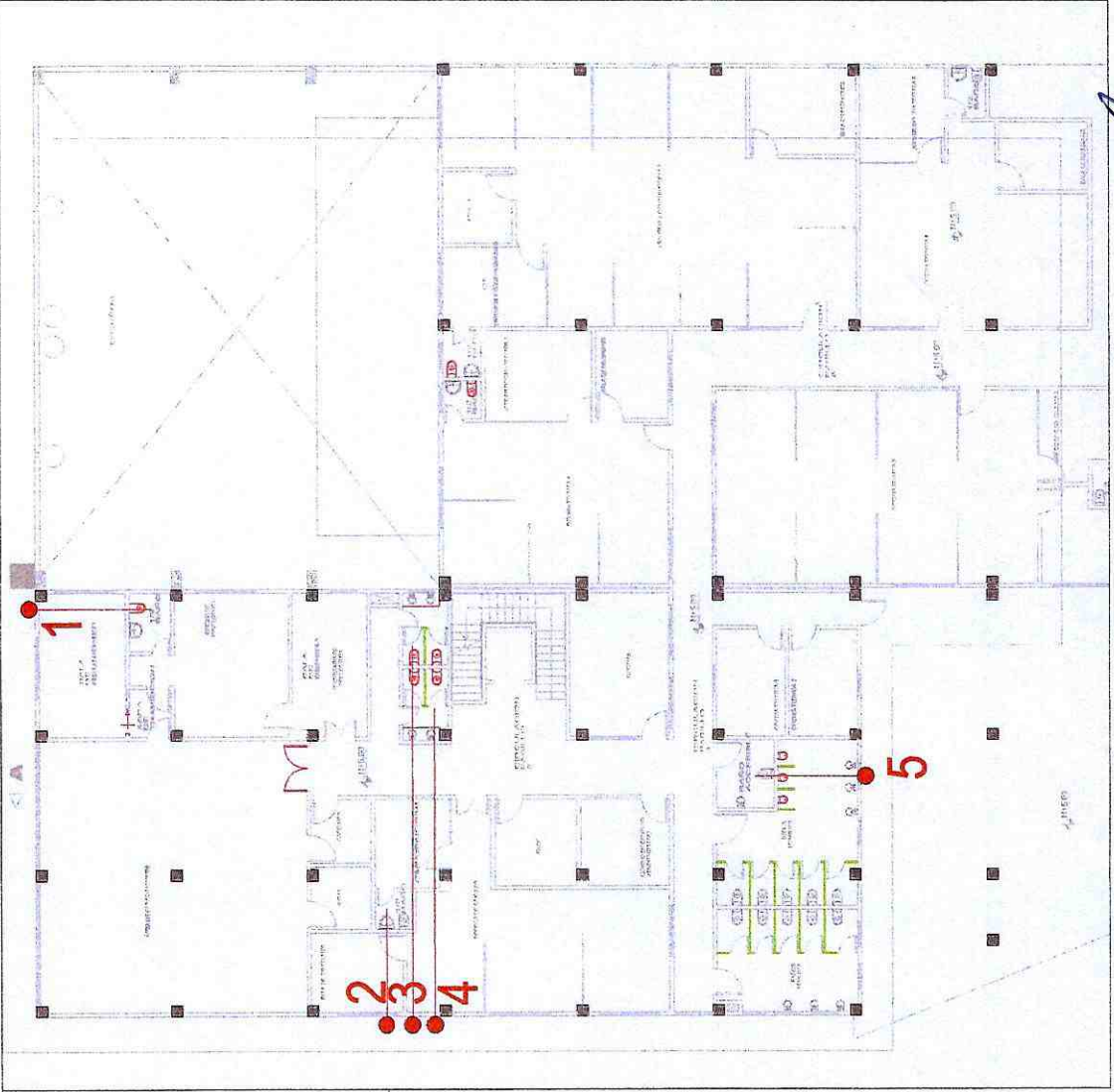

CONTRATISTA

FISCALIZACIÓN

**BIERNO AUTONOMO DESCENTRALIZADO DE
PROVINCIA DEL PASTAZA**

" CONSTRUCCIÓN DE LOS HANGARES DEL GOBIERNO AUTONOMO DESCENTRALIZADO PROVINCIAL DE PASTAZA
(GADPPz) I ETAPA, PARROQUIA FÁTIMA, CANTÓN Y PROVINCIA DE PASTAZA "

ANEXO: 6

RUBRO: RN - 19
DESCRIPCIÓN: REJILLAS DE PISO 50 MM
UNIDAD: U
PERIODO: 1 DE JUNIO 2021 A 30 DE JUNIO 2021

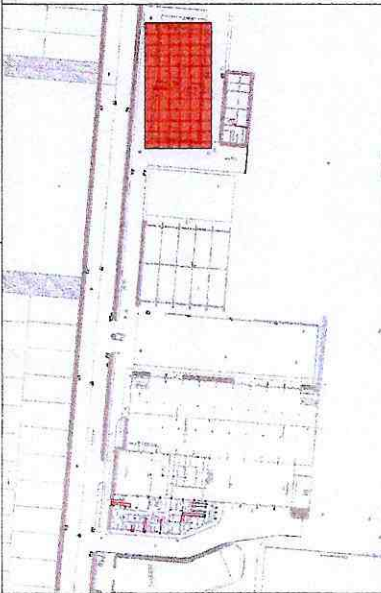

UBICACION - LAVADO ENGRASADO

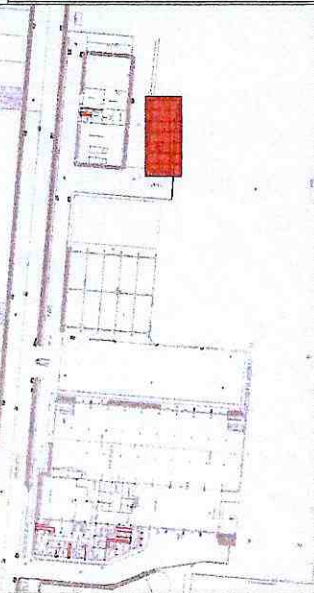
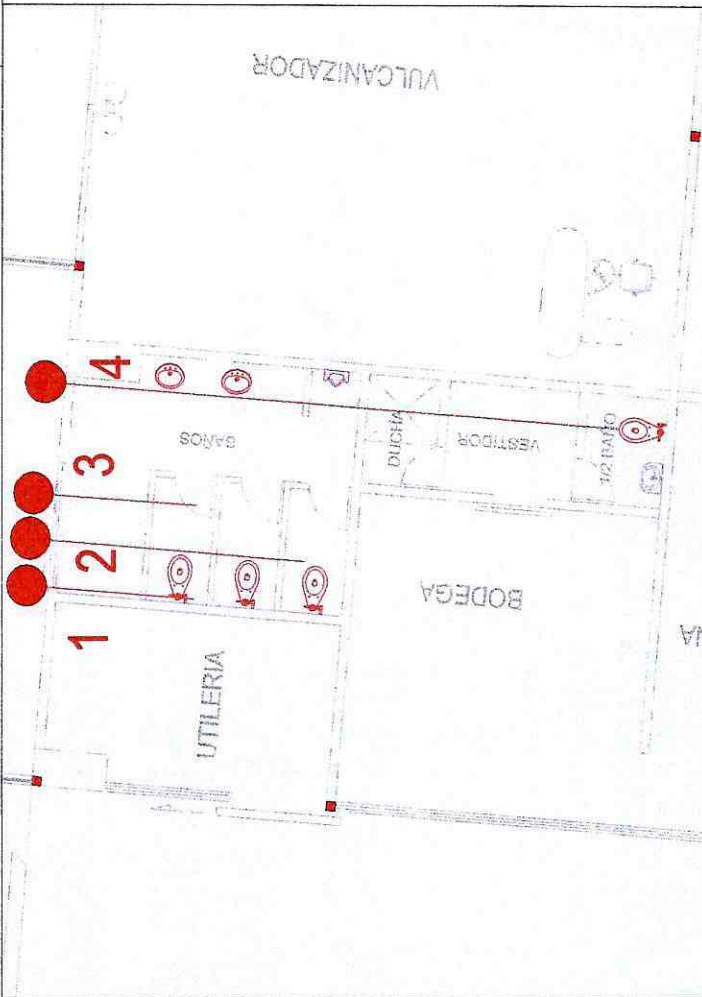

UBICACION - DESECHOS

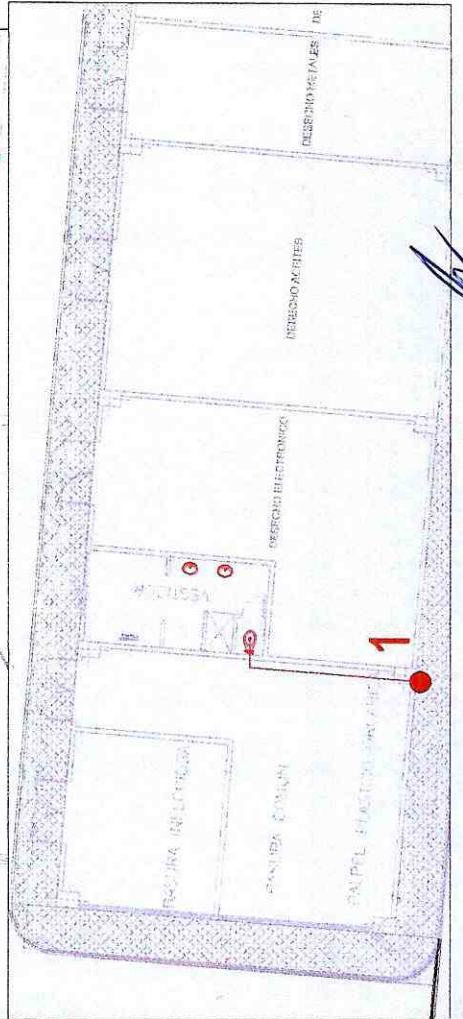

[Signature]
CONTRATISTA

[Signature]
FISCALIZACIÓN

GOBIERNO AUTÓNOMO DESCENTRALIZADO DE LA PROVINCIA DEL PASTAZA

" CONSTRUCCIÓN DE LOS HANGARES DEL GOBIERNO AUTÓNOMO DESCENTRALIZADO PROVINCIAL DE PASTAZA (GADPP2) I ETAPA, PARROQUIA FÁTIMA, CANTÓN Y PROVINCIA DE PASTAZA "



ANEXO: 1

RUBRO	RN-20
DESCRIPCION	SUMIDERO DE CUBIERTA DE 110MM INCLUYE REJILLA TIPO CÚPULA
UNIDAD	U
PERIODO	1 DE JUNIO 2021 A 30 DE JUNIO 2021

UBICACION - BAÑOS NUEVOS

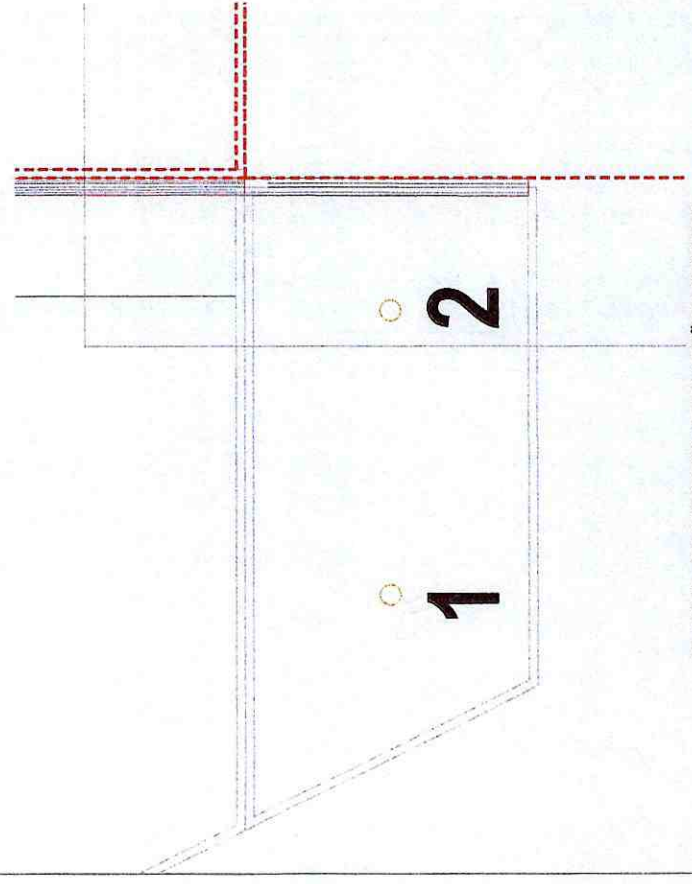
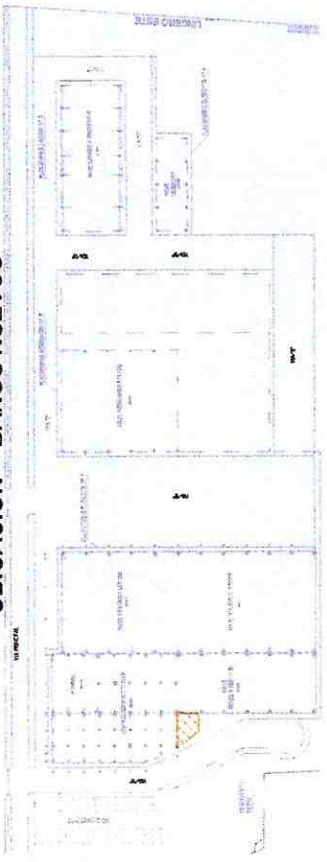

PLANTA DE CUBIERTA LOSA BAÑOS NUEVOS

CONTRATISTA

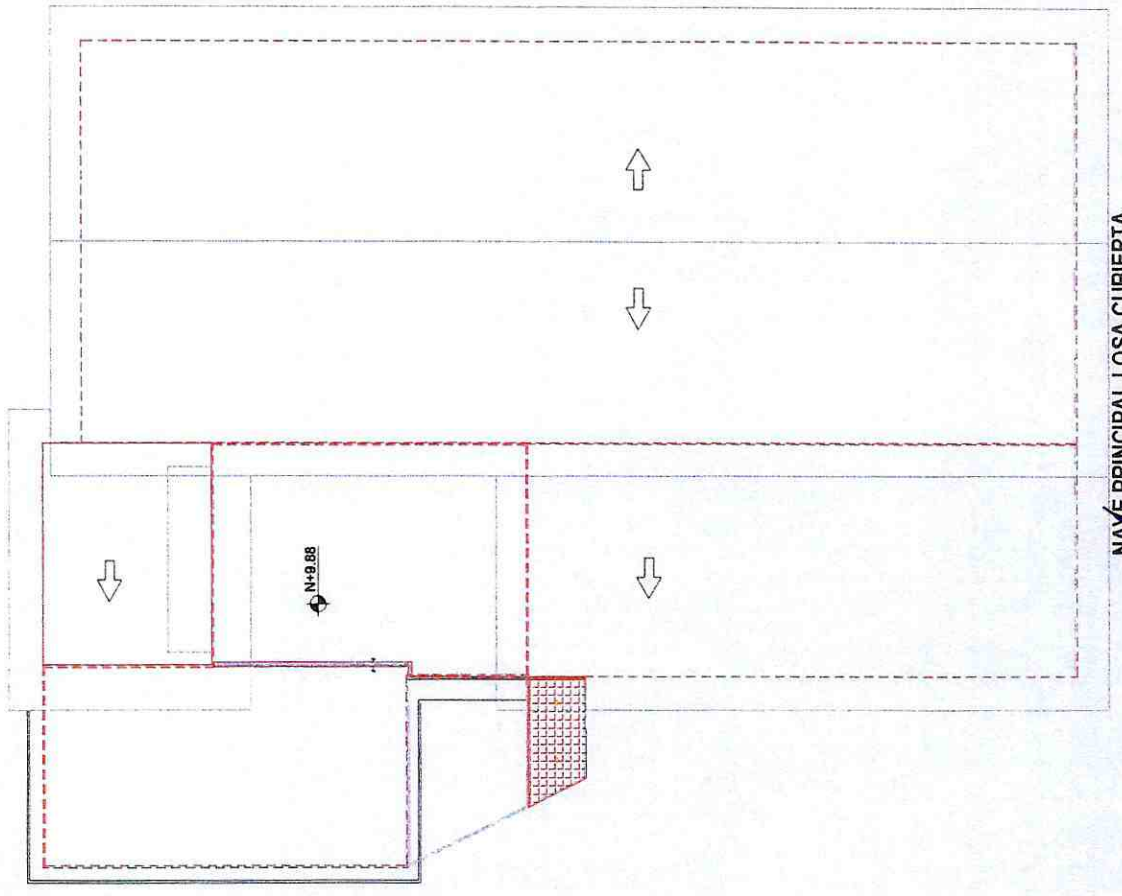

NAVE PRINCIPAL LOSA CUBIERTA

LOCALIZACIÓN

BIENIO AUTÓNOMO DESCENTRALIZADO DE PASTAZA
PROVINCIA DEL PASTAZA

PROYECTO: " CONSTRUCCIÓN DE LOS HANGARES DEL GOBIERNO AUTÓNOMO DESCENTRALIZADO PROVINCIAL DE PASTAZA (GADPPz) I ETAPA, PARROQUIA FÁTIMA, CANTÓN Y PROVINCIA DE PASTAZA "

RUBRO	RN-20	ANEXO: 2
DESCRIPCION	SUMIDERO DE CUBIERTA DE 110MM INCLUYE RESILLA TIPO CÚPULA	
UNIDAD	U	
PERIODO	1 DE JUNIO 2021 A 30 DE JUNIO 2021	



UBICACION - GARITAS

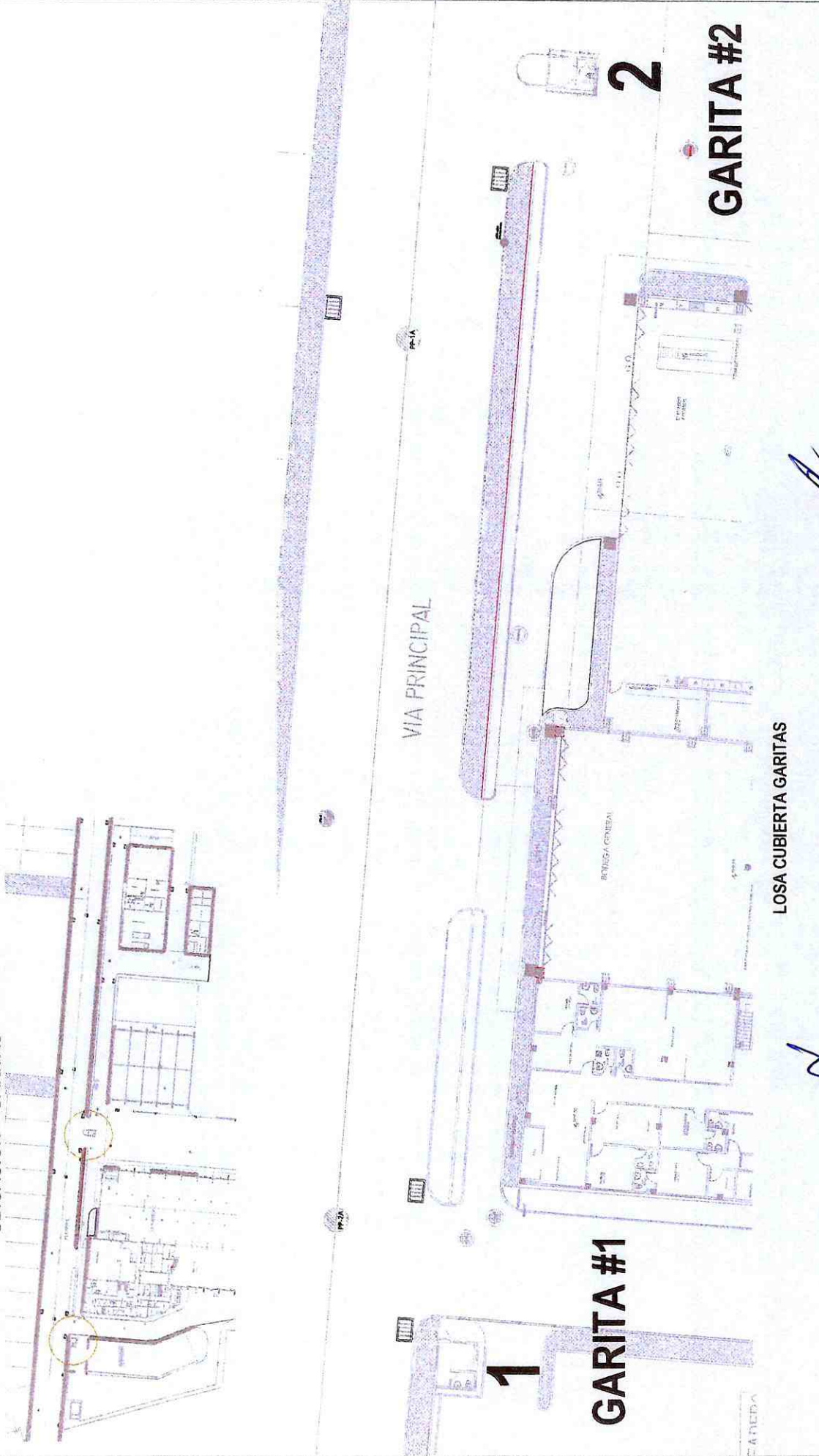

CONTRATISTA

REALIZACIÓN

GOBIERNO AUTÓNOMO DESCENTRALIZADO DE LA
PROVINCIA DEL PASTAZA

" CONSTRUCCIÓN DE LOS HANGARES DEL GOBIERNO AUTÓNOMO DESCENTRALIZADO PROVINCIAL DE PASTAZA
(GADPPz) I ETAPA, PARROQUIA FÁTIMA, CANTÓN Y PROVINCIA DE PASTAZA "

RN - 21

ANEXO: 4

RUBRO

BORDILLO PARA TINETA DE BAÑO REVESTIDA CON CERÁMICA (0,10MX0,15M)

DESCRIPCION

ML

UNIDAD

PERIODO

1 DE JUNIO 2021 A 30 DE JUNIO 2021

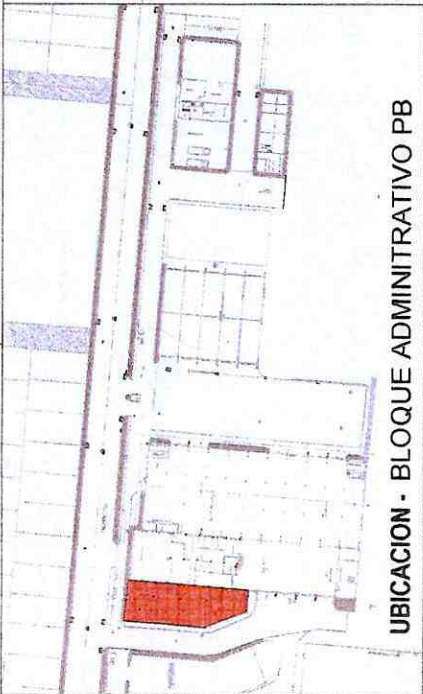

UBICACION - BLOQUE ADMINISTRATIVO PB

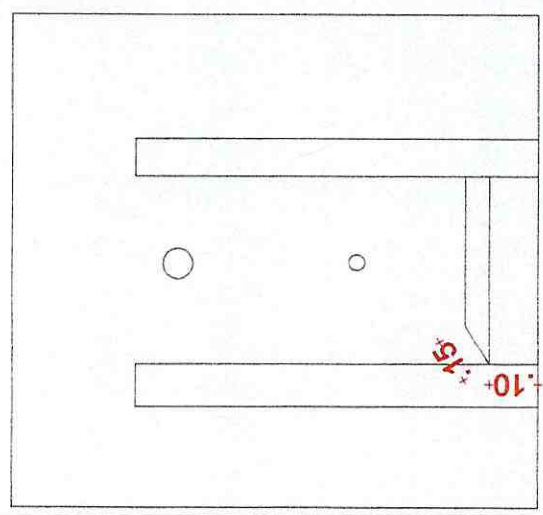
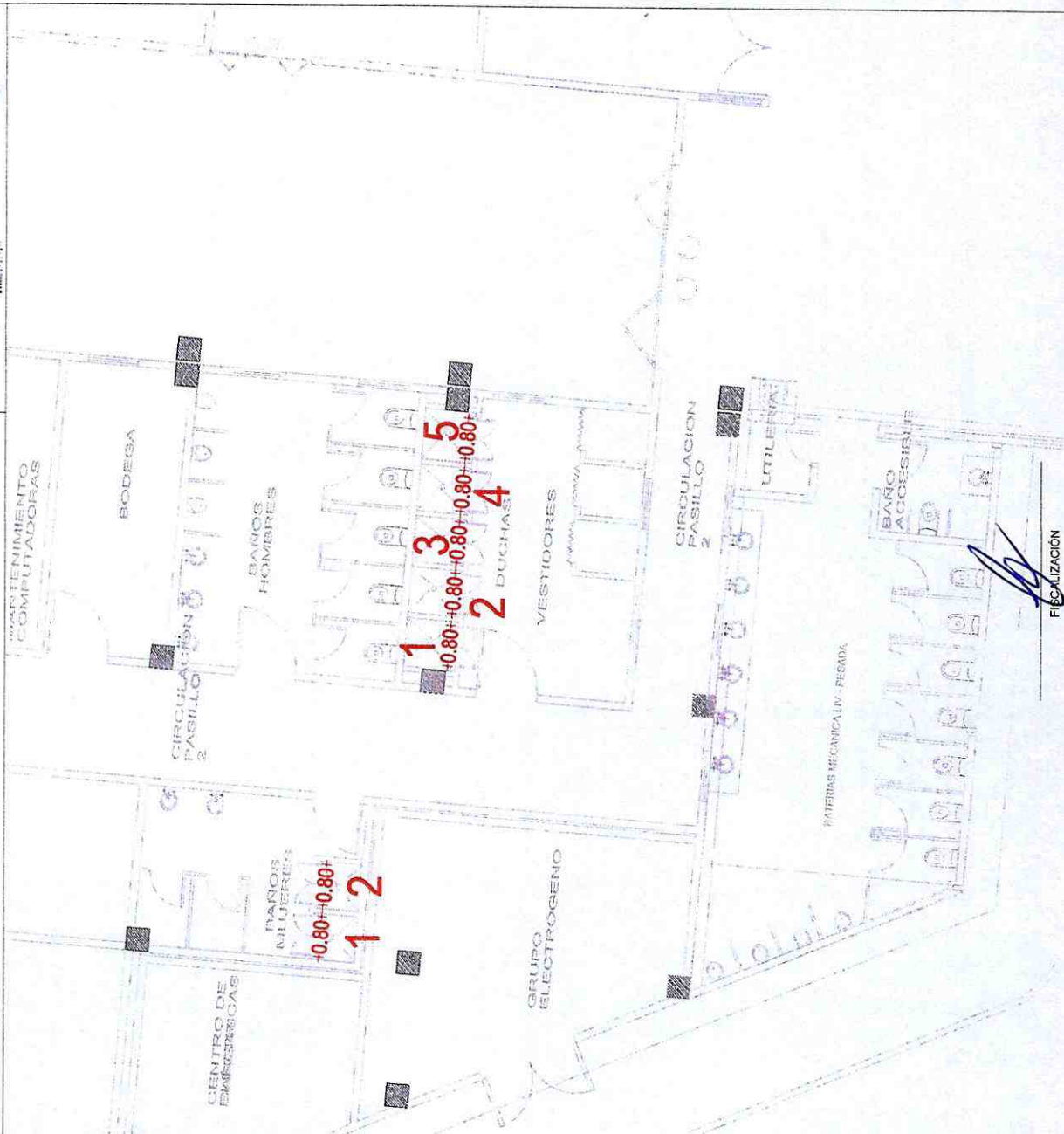

SECCION DE BORDILLO DE DUCHA

CONTRATISTA

FISCALIZACION

**GOBIERNO AUTÓNOMO DESCENTRALIZADO DE LA
PROVINCIA DEL PASTAZA**

" CONSTRUCCIÓN DE LOS HANGARES DEL GOBIERNO AUTÓNOMO DESCENTRALIZADO PROVINCIAL DE PASTAZA
(GADPPz) | ETAPA, PARROQUIA FÁTIMA, CANTÓN Y PROVINCIA DE PASTAZA "

PROYECTO:

RUBRO: RN - 21
DESCRIPCION: BORDILLO PARA TINETA DE BAÑO REVESTIDA CON CERÁMICA (0,10MX0,15M)
UNIDAD: ML
PERIODO: 1 DE JUNIO 2021 A 30 DE JUNIO 2021

ANEXO: 2

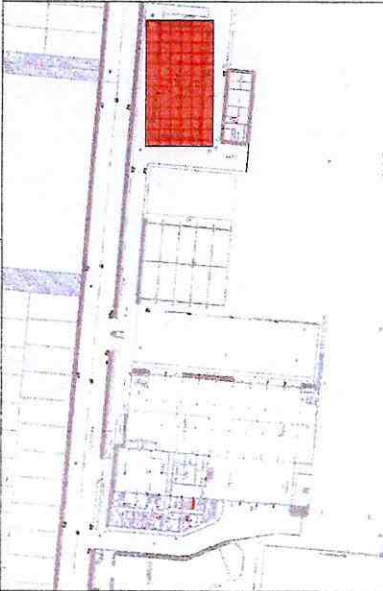

UBICACION - LAVADO ENGRASADO

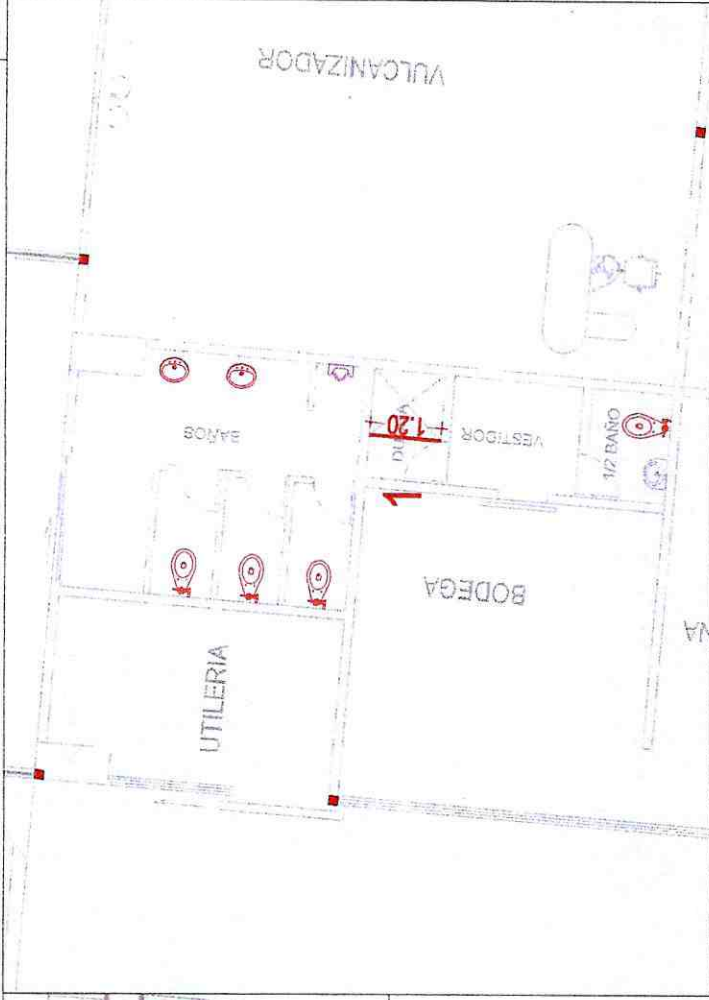

[Signature]
CONTRATISTA

[Signature]
FISCALIZACIÓN

**GOBIERNO AUTONOMO DESCENTRALIZADO DE LA
PROVINCIA DEL PASTAZA**

" CONSTRUCCIÓN DE LOS HANGARES DEL GOBIERNO AUTÓNOMO DESCENTRALIZADO PROVINCIAL DE PASTAZA
(GADPPz) | ETAPA, PARROQUIA FÁTIMA, CANTÓN Y PROVINCIA DE PASTAZA "

ANEXO: 1

RUBRO	RN-56
DESCRIPCIÓN	PAREDES DE GALVALUMEN E=0.45mm, RECUBRIMIENTO PINTURA POLIESTER ASTM-653A (COLOR INSTITUCIONAL).
UNIDAD	m ²
PERIODO	1 DE JUNIO 2021 A 30 DE JUNIO 2021



UBICACION: NAVE PRINCIPAL

REIMPLANTACION DEL PROYECTO HANGARES GADPPz



PLANTA DE CUBIERTAS

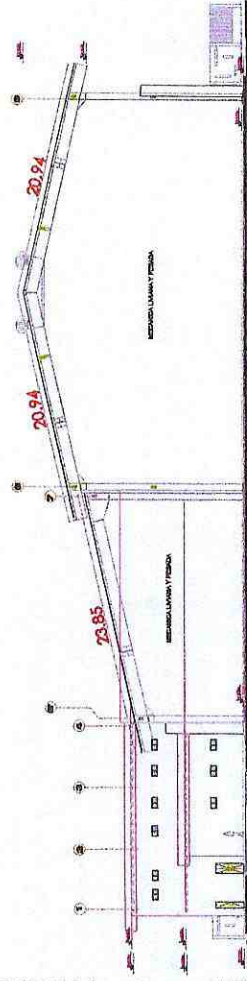
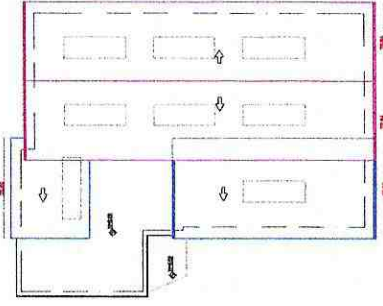

CONTRATISTA

SUPERVISACIÓN

**GOBIERNO AUTÓNOMO DESCENTRALIZADO DE LA
PROVINCIA DEL PASTAZA**

" CONSTRUCCIÓN DE LOS HANGARES DEL GOBIERNO AUTÓNOMO DESCENTRALIZADO PROVINCIAL DE PASTAZA (GADPPZ) I ETAPA, PARROQUIA FÁTIMA, CANTÓN Y PROVINCIA DE PASTAZA "



PROYECTO:	RN-56	ANEXO: 2
RUBRO	PAREDES DE GALVALUMEN E=0,45mm, RECUBRIMIENTO PINTURA POLIESTER ASTM-653A (COLOR INSTITUCIONAL).	
DESCRIPCION		
UNIDAD	m ²	
PERIODO	1 DE JUNIO 2021 A 30 DE JUNIO 2021	

UBICACION: NAVE RESGUARDO

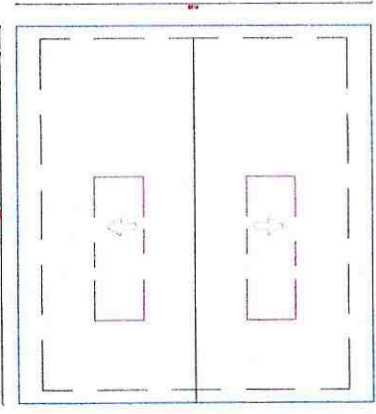
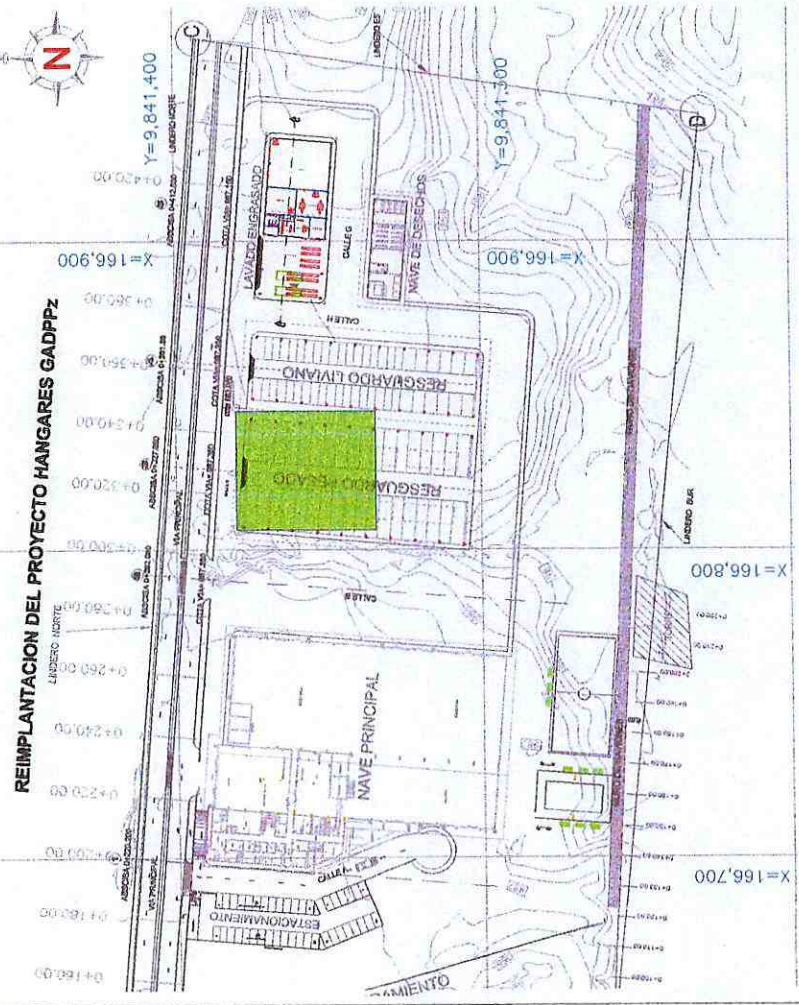

PLANTA DE CUBIERTA

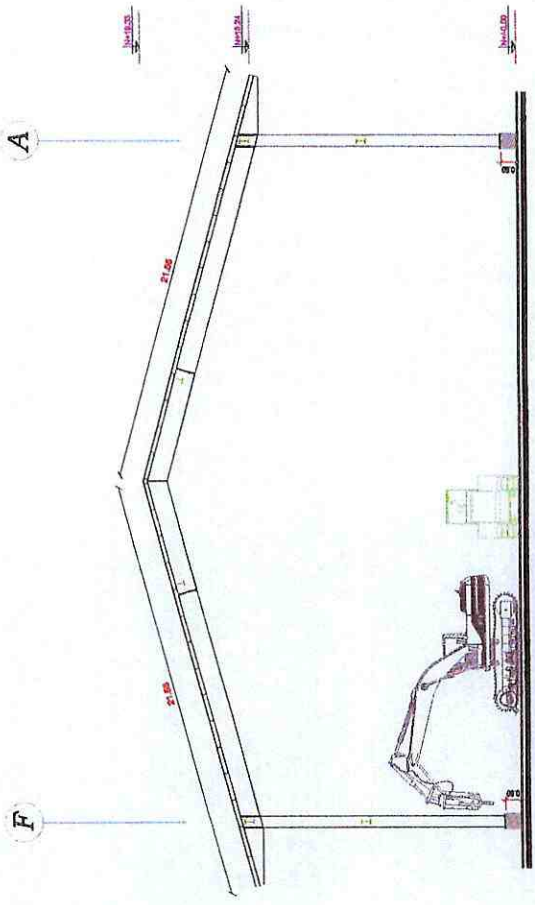

FACHADA SUR

CONTRATISTA

REALIZACION

**GOBIERNO AUTONOMO DESCENTRALIZADO DE LA
PROVINCIA DEL PASTAZA**

" CONSTRUCCIÓN DE LOS HANGARES DEL GOBIERNO AUTÓNOMO DESCENTRALIZADO PROVINCIAL DE PASTAZA
(GADPPZ) I ETAPA, PARROQUIA FÁTIMA, CANTÓN Y PROVINCIA DE PASTAZA "

PROYECTO:

RUBRO	RN-56	ANEXO: 3
DESCRIPCION	PAREDES DE GALVALUMEN E=0.45mm, RECUBRIMIENTO PINTURA POLIESTER ASTm-653A (COLOR INSTITUCIONAL).	
UNIDAD	m ²	
PERIODO	1 DE JUNIO 2021 A 20 DE JUNIO 2021	



UBICACION: NAVE LAVADO

REIMPLANTACION DEL PROYECTO HANGARES GADPPZ

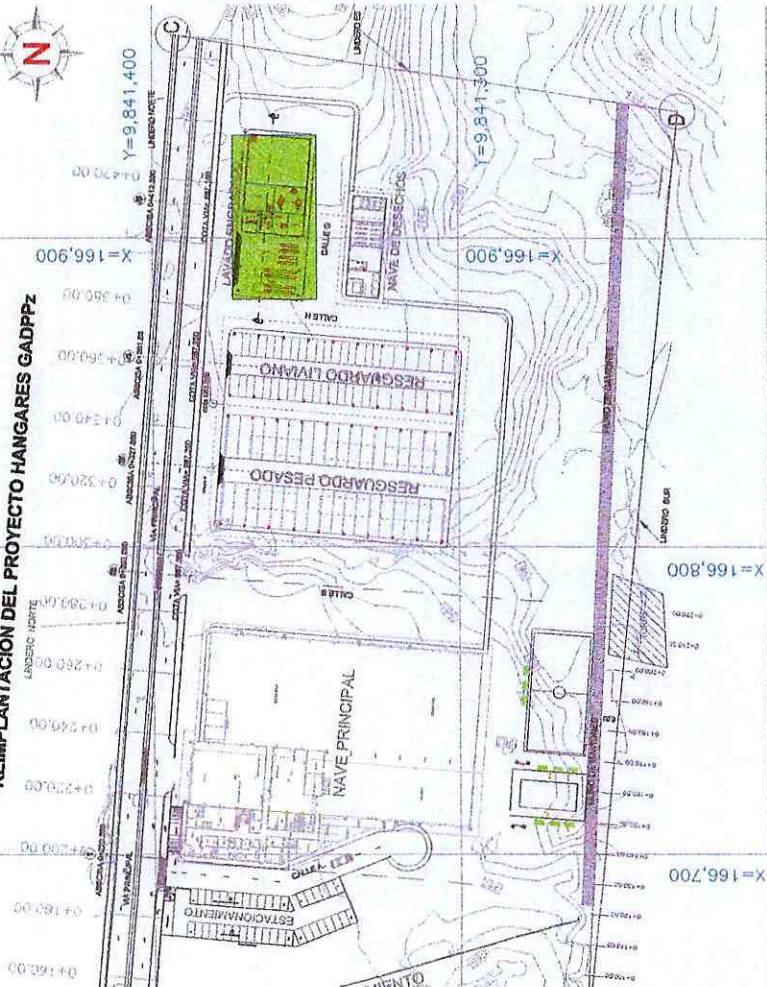

PLANTA DE CUBIERTA

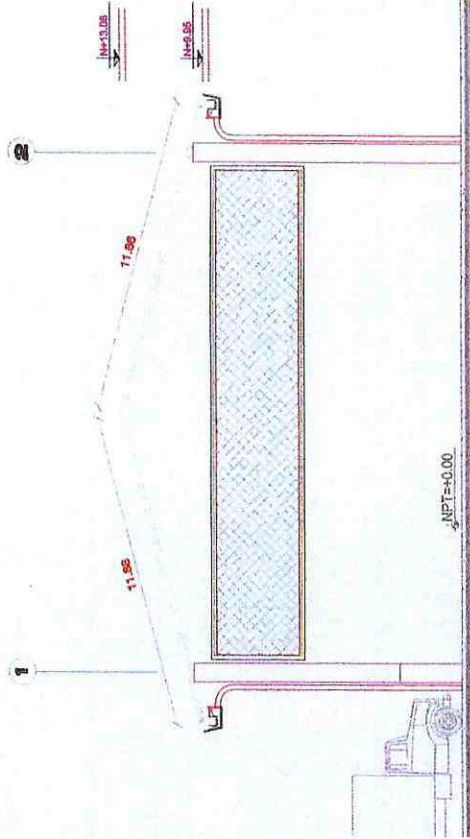
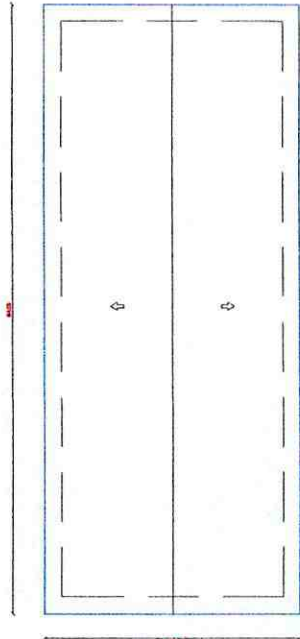

FACHADA LATERAL ESTE

[Signature]
FISCALIZACIÓN

[Signature]
CONTRATISTA

GOBIERNO AUTÓNOMO DESCENTRALIZADO DE LA
PROVINCIA DEL PASTAZA

" CONSTRUCCIÓN DE LOS HANGARES DEL GOBIERNO AUTÓNOMO DESCENTRALIZADO PROVINCIAL DE PASTAZA
(GADPPz) I ETAPA, PARROQUIA FÁTIMA, CANTÓN Y PROVINCIA DE PASTAZA "

PROYECTO:

RUBRO	RN-56	ANEXO: 4
DESCRIPCION	PAREDES DE GALVALUMEN E=0.45mm, RECUBRIMIENTO PINTURA POLIESTER ASTm-653A (COLOR INSTITUCIONAL).	
UNIDAD	m ²	
PERIODO	1 DE JUNIO 2021 A 30 DE JUNIO 2021	



PLANTA DE CUBIERTA

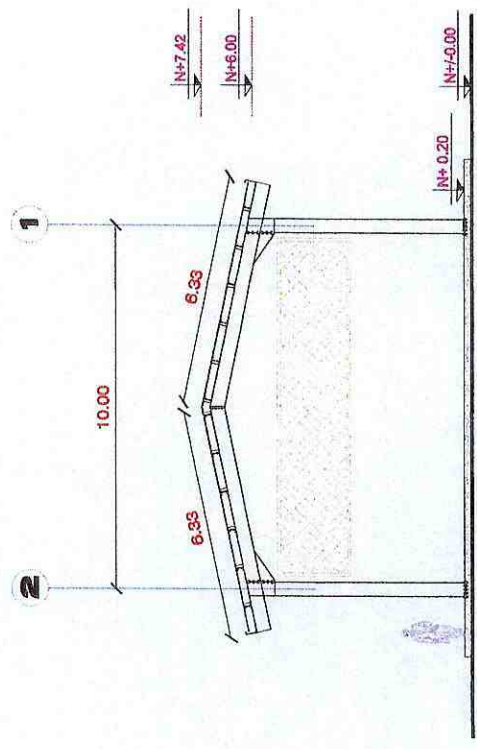
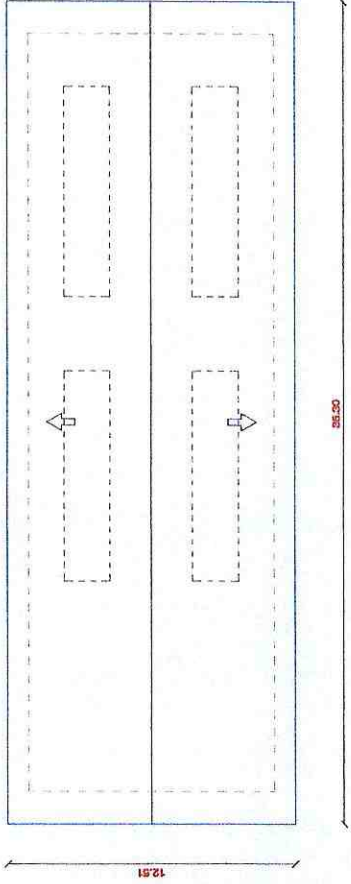

FACHADA ESTE

CONTRATISTA

UBICACION: NAVE DESECHOS

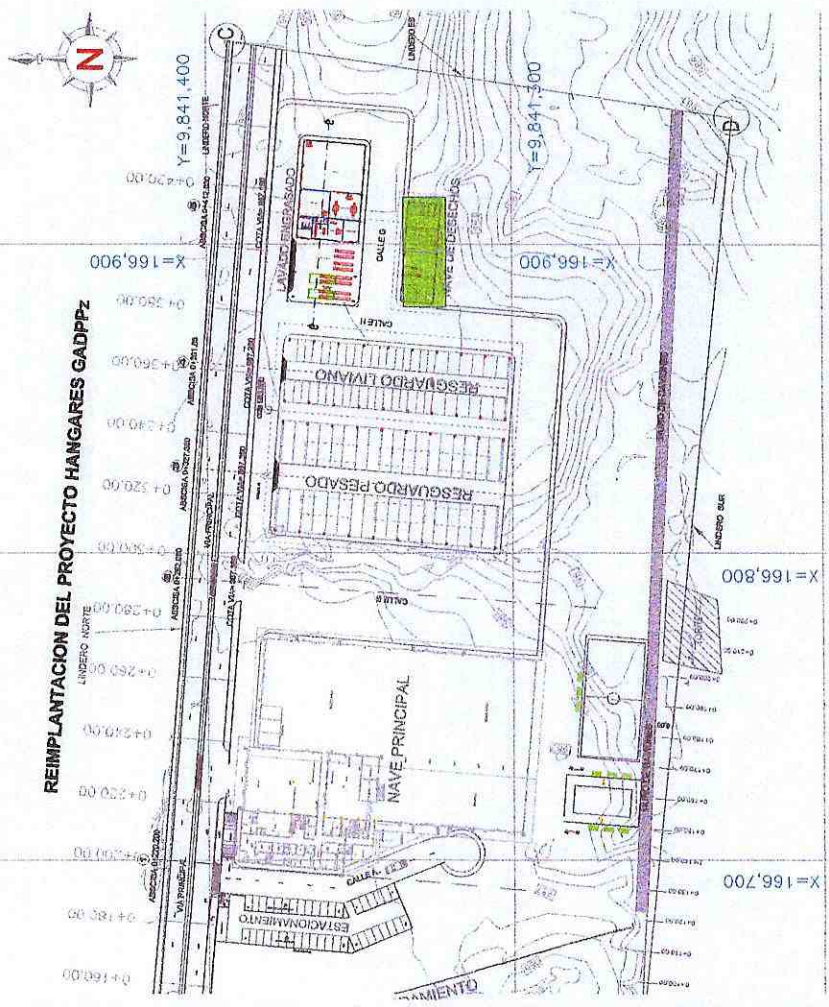

BIERNO AUTONOMO DESCENTRALIZADO DE PASTAZA
PROVINCIA DEL PASTAZA

" CONSTRUCCIÓN DE LOS HANGARES DEL GOBIERNO AUTÓNOMO DESCENTRALIZADO PROVINCIAL DE PASTAZA
 (GADPPz) I ETAPA, PARROQUIA FÁTIMA, CANTÓN Y PROVINCIA DE PASTAZA "



PROYECTO:	RN-57	ANEXO: 1
RUBRO	CERRAMIENTO TUBO ISO2 H.G. 2 " -mALLA ELECTROSOLDADA 10X10X6mm, INC. PINTURA A ComPRESOR	
DESCRIPCION	m2	
UNIDAD		
PERIODO	1 DE JUNIO 2021 A 30 DE JUNIO 2021	

CERRAMIENTO MALLA PTAR



CERRAMIENTO DE PTAR

CONTRATISTA

FISCALIZACION

GUBIERNO AUTONOMO DESCENTRALIZADO DE LA PROVINCIA DEL PASTAZA

* CONSTRUCCIÓN DE LOS HANGARES DEL GOBIERNO AUTÓNOMO DESCENTRALIZADO PROVINCIAL DE PASTAZA (GADPPz) | ETAPA, PARROQUIA FÁTIMA, CANTÓN Y PROVINCIA DE PASTAZA *

RUBRO	RN-58	ANEXO: 1
DESCRIPCION	CERRAMIENTO VERJA DE TUBO HG 2" Y TUBO RECT 80X40X2, INC. PINTURA COMPRESOR	
UNIDAD	m2	
PERIODO	1 DE JUNIO 2021 A 30 DE JUNIO 2021	



UBICACION - PORTONES DE INGRESO

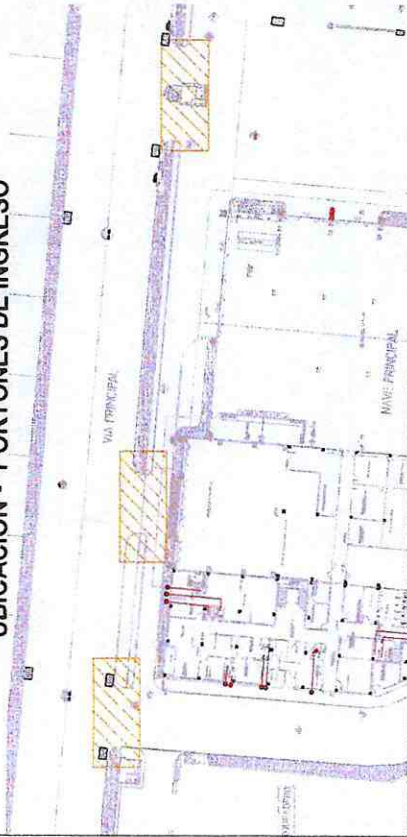

UBICACION - PORTON INGRESO 1

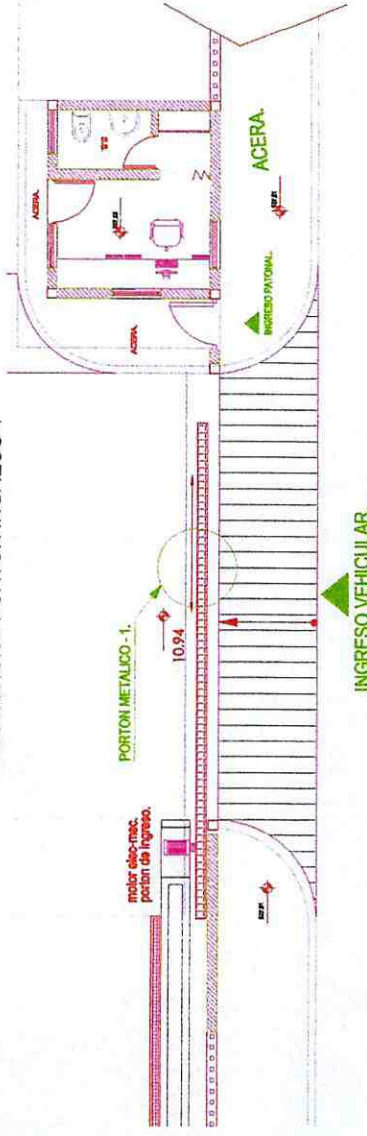

UBICACION - PORTON INGRESO 2

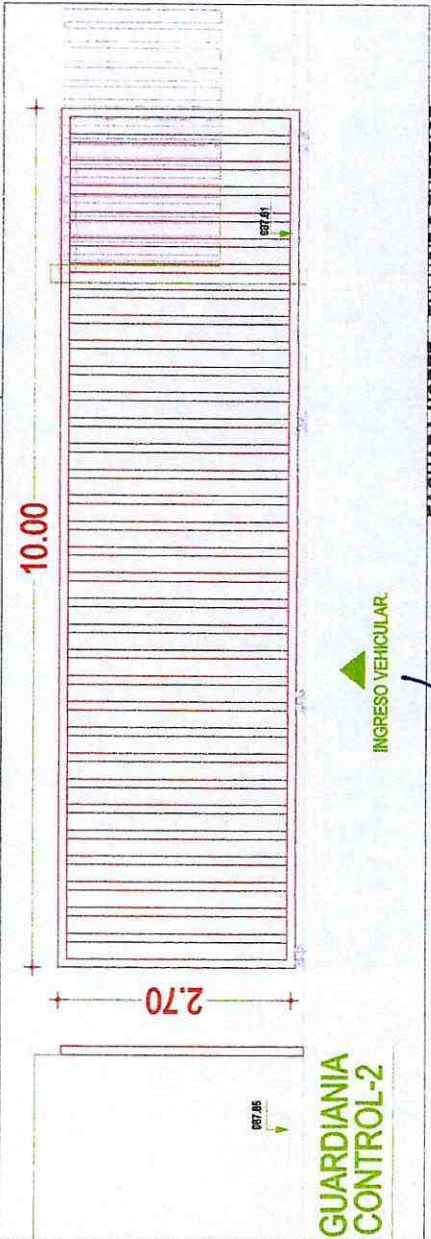
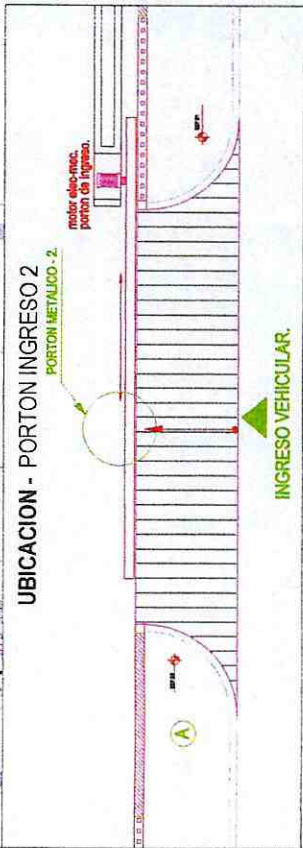

FACHADA NORTE - ENLUCIDO EXTERIOR

CONTRATISTA

FINALIZACIÓN

**GOBIERNO AUTÓNOMO DESCENTRALIZADO DE LA
PROVINCIA DEL PASTAZA**

" CONSTRUCCIÓN DE LOS HANGARES DEL GOBIERNO AUTÓNOMO DESCENTRALIZADO PROVINCIAL DE PASTAZA
(GADPPz) I ETAPA, PARROQUIA FÁTIMA, CANTÓN Y PROVINCIA DE PASTAZA "



PROYECTO:	
RUBRO	RN-58
DESCRIPCION	CERRAMIENTO VERJA DE TUBO HG 2" Y TUBO RECT 80X40X2, INC. PINTURA COMPRESOR
UNIDAD	m2
PERIODO	1 DE JUNIO 2021 A 30 DE JUNIO 2021

ANEXO: 2

UBICACION - PORTON INGRESO 3-4

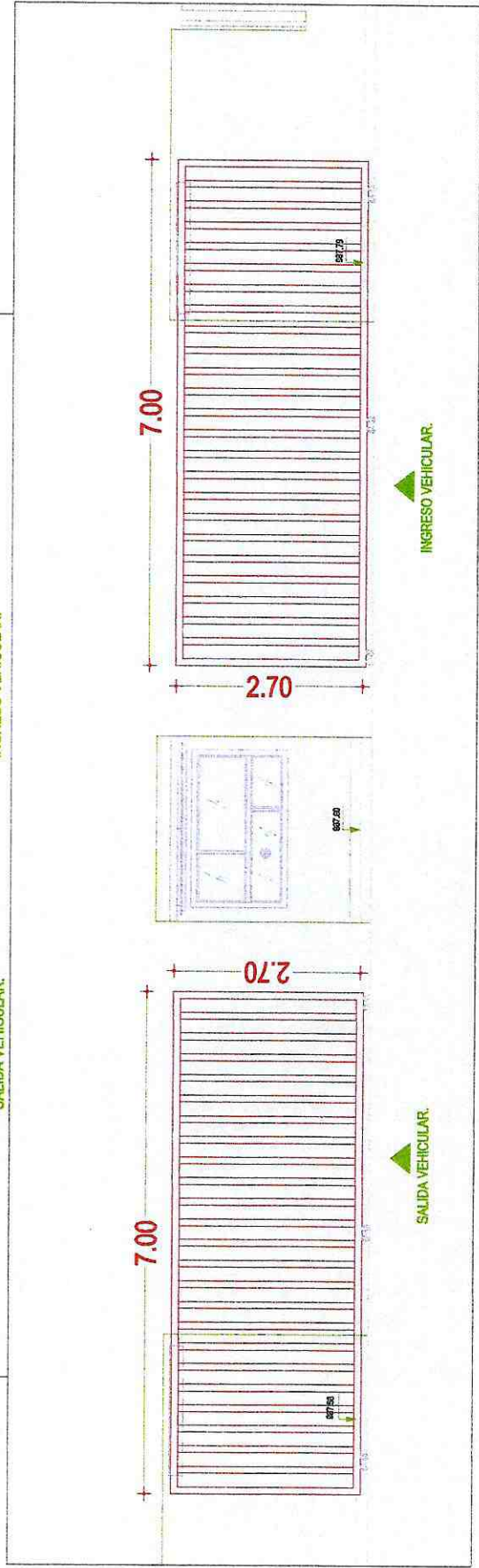

CONCATISTA

FACHADA NORTE - ENLUCIDO EXTERIOR

FISCALIZACIÓN

GOBIERNO AUTÓNOMO DESCENTRALIZADO DE LA PROVINCIA DEL PASTAZA

PROYECTO " CONSTRUCCIÓN DE LOS HANGARES DEL GOBIERNO AUTÓNOMO DESCENTRALIZADO PROVINCIAL DE PASTAZA (GADPPz) I ETAPA, PARROQUIA FÁTIMA, CANTÓN Y PROVINCIA DE PASTAZA "

PLANILLA DE AVANCE DE OBRA No. 23

RUBRO N° RN-59 ANEXO 1
 DESCRIPCIÓN: RECuBRImIENTO ALUmINIO COLOR CYAN O SImILAR, ALuCuBOND 4mm INC. ESTRuCT. E INST<GuÍA
 UNIDAD: M2
 PERIODO: 01-jun 30-jun



PAG. 1 DE 1

RECUBRIMIENTO ALUMINIO COLOR CYAN O SIMILAR, ALUCUBOND 4mm INC. ESTRUCT. E INST<GUÍA IMAGEN CORPORATI					
AREA DE LOSA CUBIERTA MEZANINE					
DESCRIPCION	LARGO (X)	AREA	No.	SUBTOTAL	TOTAL
RECUBRIMIENTO ALUMINIO COLOR CYAN O SIMILAR, ALUCUBOND 4mm INC. ESTRUCT. E INST<GUÍA IMAGEN CORPORATI		101,53	1	101,53	101,53
RECUBRIMIENTO ALUMINIO MEZANINE		75,00	1	75	75
				TOTAL	176,53

RESUMEN DE PLANILLA AL 100%					
DESCRIPCION	CONTRATADO	ANTERIOR	ACTUAL	ACUMULADO	UNIDAD
RECUBRIMIENTO ALUMINIO COLOR CYAN O SIMILAR, ALUCUBOND 4mm INC. ESTRUCT. E INST<GUÍA IMAGEN	1.315,00	800,87	176,53	977,40	M2



 CONTRATISTA



 FISCALIZACIÓN

**GOBIERNO AUTONOMO DESCENTRALIZADO DE LA
PROVINCIA DEL PASTAZA**

" CONSTRUCCIÓN DE LOS HANGARES DEL GOBIERNO AUTÓNOMO DESCENTRALIZADO PROVINCIAL DE PASTAZA
(GADPPz) I ETAPA, PARROQUIA FÁTIMA, CANTÓN Y PROVINCIA DE PASTAZA "

RN - 59

ANEXO: 1

DESCRIPCION RECuBRimiento ALUMINIO COLOR CYAN O SIMILAR, ALuCuBOND 4mm INC. ESTRUCT. E INST<Guía, ImAGEN CORPORATI

UNIDAD m²

PERIODO 1 DE JUNIO 2021 A 31 DE JUNIO 2021



UBICACION -ALUCUBOND EN MEZANINE

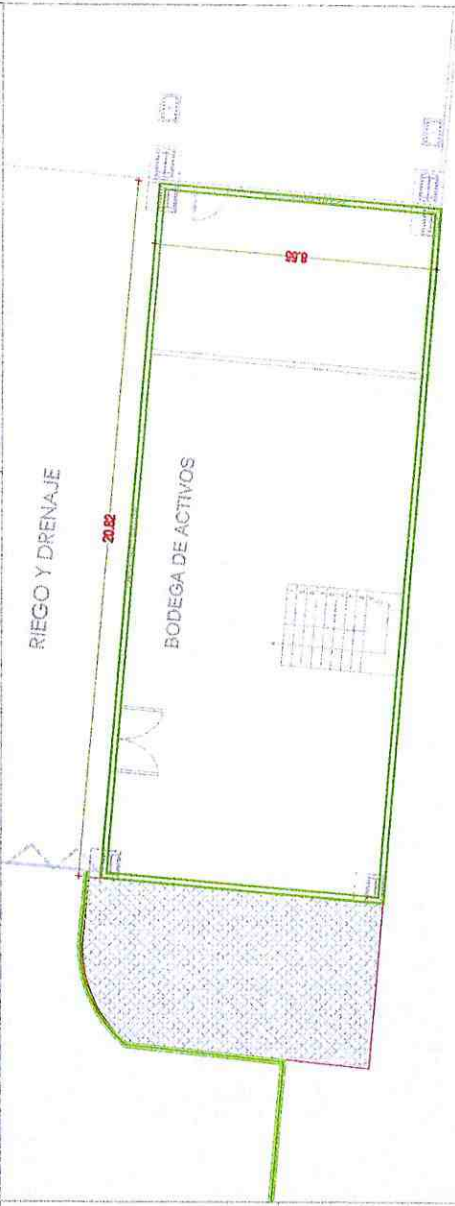

SECCIONES DE ALUCUBOND EN MEZANINE EN LOSA CUBIERTA

[Signature]
CONTRATISTA

[Signature]
CALZACION

PLANILLA Nº 23

Avance de obra

1-Junio-2021 al 30-Junio-2021

ARCHIVO FOTOGRAFICO



PROYECTO:		"CONSTRUCCIÓN DE LOS HANGARES DEL GOBIERNO AUTONOMO DESCENTRALIZADO PROVINCIAL DE PASTAZA (GADPPz)-I ETAPA, PARROQUIA FÁTIMA, CANTÓN Y PROVINCIAL DE PASTAZA" (CÓDIGO: LICO-GADPPz-001-2018).		
UBICACIÓN:	PROVINCIA:	PASTAZA	RUBRO :	2
	CANTÓN:	PUYO	ANEXO :	1
	PARROQUIA:	FÁTIMA	DESCRIPCION :	EXCAVACIÓN SIN CLASIFICAR(mov.DE TIERRA)
	ARCHIVO FOTOGRÁFICO		FECHA:	1 DE JUNIO 2021 A 30 DE JUNIO 2021
EXCAVACIÓN SIN CLASIFICAR(mov.DE TIERRA)				
EXCAVACIÓN SIN CLASIFICAR(mov.DE TIERRA)				

CONTRATISTA

FISCALIZACIÓN



PROYECTO:		"CONSTRUCCION DE LOS HANGARES DEL GOBIERNO AUTONOMO DESCENTRALIZADO PROVINCIAL DE PASTAZA (GADPPz)-I ETAPA, PARROQUIA FÁTIMA, CANTÓN Y PROVINCIAL DE PASTAZA" (CÓDIGO: LICO-GADPPz-001-2018).		
UBICACIÓN:	PROVINCIA:	PASTAZA	RUBRO:	3
	CANTÓN:	PUYO	ANEXO:	1
	PARROQUIA:	FÁTIMA	DESCRIPCION:	EXCAVACION Y RELLENO DE ESTRuCTuRAS mENORES
	ARCHIVO FOTOGRÁFICO	FECHA:	1 DE JUNIO 2021 A 30 DE JUNIO 2021	

EXCAVACION Y RELLENO DE ESTRuCTuRAS mENORES



EXCAVACION Y RELLENO DE ESTRuCTuRAS mENORES





 CONTRATISTA



 FISCALIZACIÓN



PROYECTO: "CONSTRUCCIÓN DE LOS HANGARES DEL GOBIERNO AUTÓNOMO DESCENTRALIZADO PROVINCIAL DE PASTAZA (GADPPz)-I ETAPA, PARROQUIA FÁTIMA, CANTÓN Y PROVINCIAL DE PASTAZA" (CÓDIGO: LICO-GADPPz-001-2018).

UBICACIÓN:	PROVINCIA:	PASTAZA	RUBRO :	6
	CANTÓN:	PUYO	ANEXO :	1
	PARROQUIA:	FÁTIMA	DESCRIPCION :	mATERIAL PETREO DE mEJORAmIENTO(mINADA , CARGADA Y .REGADA)
	ARCHIVO FOTOGRÁFICO		FECHA:	1 DE JUNIO 2021 A 30 DE JUNIO 2021

mATERIAL PETREO DE mEJORAmIENTO(mINADA , CARGADA Y .REGADA) mATERIAL PETREO DE mEJORAmIENTO(mINADA , CARGADA Y .REGADA)



mATERIAL PETREO DE mEJORAmIENTO(mINADA , CARGADA Y .REGADA) mATERIAL PETREO DE mEJORAmIENTO(mINADA , CARGADA Y .REGADA)



mATERIAL PETREO DE mEJORAmIENTO(mINADA , CARGADA Y .REGADA) mATERIAL PETREO DE mEJORAmIENTO(mINADA , CARGADA Y .REGADA)



[Signature]

CONTRATISTA

[Signature]

FISCALIZACIÓN



PROYECTO: "CONSTRUCCION DE LOS HANGARES DEL GOBIERNO AUTONOMO DESCENTRALIZADO PROVINCIAL DE PASTAZA (GADPPz)-I ETAPA, PARROQUIA FÁTIMA, CANTÓN Y PROVINCIAL DE PASTAZA" (CÓDIGO: LICO-GADPPz-001-2018).

UBICACIÓN:	PROVINCIA:	PASTAZA	RUBRO:	7
	CANTÓN:	PUYO	ANEXO:	1
	PARROQUIA:	FÁTIMA	DESCRIPCIÓN:	mATERIAL DE SUBBASE CLASE 3
	ARCHIVO FOTOGRÁFICO	FECHA:	1 DE JUNIO 2021 A 30 DE JUNIO 2021	

mATERIAL DE SUBBASE CLASE 3



mATERIAL DE SUBBASE CLASE 3



mATERIAL DE SUBBASE CLASE 3



[Signature]
CONTRATISTA

[Signature]
FISCALIZACIÓN

PROYECTO:

"CONSTRUCCION DE LOS HANGARES DEL GOBIERNO AUTONOMO DESCENTRALIZADO PROVINCIAL DE PASTAZA (GADPPz)-I ETAPA, PARROQUIA FÁTIMA, CANTÓN Y PROVINCIAL DE PASTAZA" (CÓDIGO: LICO-GADPPz-001-2018).

UBICACIÓN:

PROVINCIA:	PASTAZA	RUBRO :	8
CANTÓN:	PUYO	ANEXO :	1
PARROQUIA:	FÁTIMA	DESCRIPCION :	mATERIAL DE BASE GRANULAR DE AGREGADOS
ARCHIVO FOTOGRAFICO		FECHA:	1 DE JUNIO 2021 A 30 DE JUNIO 2021

mATERIAL DE BASE GRANULAR DE AGREGADOS



mATERIAL DE BASE GRANULAR DE AGREGADOS

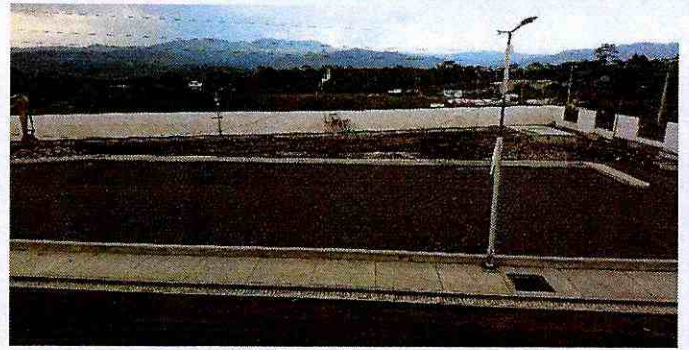

mATERIAL DE BASE GRANULAR DE AGREGADOS



mATERIAL DE BASE GRANULAR DE AGREGADOS



mATERIAL DE BASE GRANULAR DE AGREGADOS



mATERIAL DE BASE GRANULAR DE AGREGADOS



CONTRATISTA

FISCALIZACIÓN



PROYECTO: "CONSTRUCCIÓN DE LOS HANGARES DEL GOBIERNO AUTONOMO DESCENTRALIZADO PROVINCIAL DE PASTAZA (GADPPz)-I ETAPA, PARROQUIA FÁTIMA, CANTÓN Y PROVINCIAL DE PASTAZA" (CÓDIGO: LICO-GADPPz-001-2018).

UBICACIÓN:	PROVINCIA:	PASTAZA	RUBRO:	9
	CANTÓN:	PUYO	ANEXO:	1
	PARROQUIA:	FÁTIMA	DESCRIPCION:	TRANSPORTE mATERIAL PETREODE mEJORAmIENTO
	ARCHIVO FOTOGRÁFICO:		FECHA:	1 DE JUNIO 2021 A 30 DE JUNIO 2021

TRANSPORTE mATERIAL PETREODE mEJORAmIENTO



TRANSPORTE mATERIAL PETREODE mEJORAmIENTO



TRANSPORTE mATERIAL PETREODE mEJORAmIENTO



CONTRATISTA

FISCALIZACIÓN

FATIMA

C O N S O R C I O

PROYECTO: "CONSTRUCCION DE LOS HANGARES DEL GOBIERNO AUTONOMO DESCENTRALIZADO PROVINCIAL DE PASTAZA (GADPPz)-I ETAPA, PARROQUIA FÁTIMA, CANTÓN Y PROVINCIAL DE PASTAZA" (CÓDIGO: LICO-GADPPz-001-2018).

UBICACIÓN:	PROVINCIA:	PASTAZA	RUBRO :	10
	CANTÓN:	PUYO	ANEXO :	1
	PARROQUIA:	FÁTIMA	DESCRIPCION :	TRANSPORTE DE MATERIAL DE SuBBASE CLASE 3
	ARCHIVO FOTOGRÁFICO	FECHA:	1 DE JUNIO 2021 A 30 DE JUNIO 2021	

TRANSPORTE DE MATERIAL DE SuBBASE CLASE 3



TRANSPORTE DE MATERIAL DE SuBBASE CLASE 3



TRANSPORTE DE MATERIAL DE SuBBASE CLASE 3



TRANSPORTE DE MATERIAL DE SuBBASE CLASE 3

CONTRATISTA

FISCALIZACIÓN

PROYECTO:

“CONSTRUCCION DE LOS HANGARES DEL GOBIERNO AUTONOMO DESCENTRALIZADO PROVINCIAL DE PASTAZA (GADPPz)-I ETAPA, PARROQUIA FÁTIMA, CANTÓN Y PROVINCIAL DE PASTAZA” (CÓDIGO: LICO-GADPPz-001-2018).

UBICACIÓN:

PROVINCIA:	PASTAZA	RUBRO :	11
CANTÓN:	PUYO	ANEXO :	1
PARROQUIA:	FÁTIMA	DESCRIPCION :	TRANSPORTE DE MATERIAL DE BASE GRANULAR DE AGREGADOS
ARCHIVO FOTOGRAFICO		FECHA:	1 DE JUNIO 2021 A 30 DE JUNIO 2021

TRANSPORTE DE MATERIAL DE BASE GRANULAR DE AGREGADOS



TRANSPORTE DE MATERIAL DE BASE GRANULAR DE AGREGADOS



TRANSPORTE DE MATERIAL DE BASE GRANULAR DE AGREGADOS



TRANSPORTE DE MATERIAL DE BASE GRANULAR DE AGREGADOS



TRANSPORTE DE MATERIAL DE BASE GRANULAR DE AGREGADOS



TRANSPORTE DE MATERIAL DE BASE GRANULAR DE AGREGADOS



CONTRATISTA

FISCALIZACIÓN



PROYECTO: "CONSTRUCCION DE LOS HANGARES DEL GOBIERNO AUTONOMO DESCENTRALIZADO PROVINCIAL DE PASTAZA (GADPPz)-I ETAPA, PARROQUIA FÁTIMA, CANTÓN Y PROVINCIAL DE PASTAZA" (CÓDIGO: LICO-GADPPz-001-2018).	
UBICACIÓN:	PROVINCIA: PASTAZA RUBRO: 18
	CANTÓN: PUYO ANEXO: 1
	PARROQUIA: FÁTIMA DESCRIPCION: ARREGLO Y LIMPIEZA (INCLUYE DESALOJO)
	ARCHIVO FOTOGRAFICO FECHA: 1 DE JUNIO 2021 A 30 DE JUNIO 2021
ARREGLO Y LIMPIEZA (INCLUYE DESALOJO)	
ARREGLO Y LIMPIEZA (INCLUYE DESALOJO)	







 CONTRATISTA



 FISCALIZACIÓN



PROYECTO:		"CONSTRUCCION DE LOS HANGARES DEL GOBIERNO AUTONOMO DESCENTRALIZADO PROVINCIAL DE PASTAZA (GADPPz)-I ETAPA, PARROQUIA FÁTIMA, CANTÓN Y PROVINCIAL DE PASTAZA" (CÓDIGO: LICO-GADPPz-001-2018).		
UBICACIÓN:	PROVINCIA:	PASTAZA	RUBRO :	19
	CANTÓN:	PUYO	ANEXO :	1
	PARROQUIA:	FÁTIMA	DESCRIPCION :	TRAZO, REPLANTEO Y NIVELACION DE EDIFICACIONES, PARQUEADERO, Y PLATAFORMAS (EQ. TOPOGRAFICO)
	ARCHIVO FOTOGRAFICO		FECHA:	1 DE JUNIO 2021 A 30 DE JUNIO 2021
TRAZO, REPLANTEO Y NIVELACION DE EDIFICACIONES, PARQUEADERO, Y PLATAFORMAS (EQ. TOPOGRAFICO)				
				
TRAZO, REPLANTEO Y NIVELACION DE EDIFICACIONES, PARQUEADERO, Y PLATAFORMAS (EQ. TOPOGRAFICO)				
				



 CONTRATISTA



 FISCALIZACIÓN



PROYECTO: "CONSTRUCCION DE LOS HANGARES DEL GOBIERNO AUTONOMO DESCENTRALIZADO PROVINCIAL DE PASTAZA (GADPPz)-I ETAPA, PARROQUIA FÁTIMA, CANTÓN Y PROVINCIAL DE PASTAZA" (CÓDIGO: LICO-GADPPz-001-2018).

UBICACIÓN:	PROVINCIA:	PASTAZA	RUBRO:	41
	CANTÓN:	PUYO	ANEXO:	1
	PARROQUIA:	FÁTIMA	DESCRIPCION:	ENTIBADO DE ZANJA
	ARCHIVO FOTOGRÁFICO		FECHA:	1 DE JUNIO 2021 A 30 DE JUNIO 2021

ENTIBADO DE ZANJA



ENTIBADO DE ZANJA

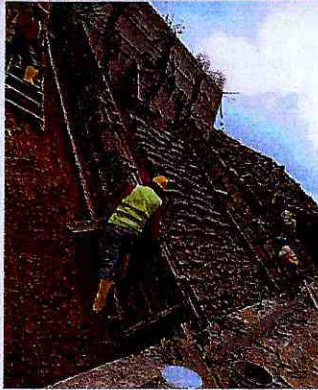

CONTRATISTA

FISCALIZACIÓN



PROYECTO:

"CONSTRUCCION DE LOS HANGARES DEL GOBIERNO AUTONOMO DESCENTRALIZADO PROVINCIAL DE PASTAZA (GADPPz)-I ETAPA, PARROQUIA FÁTIMA, CANTÓN Y PROVINCIAL DE PASTAZA" (CÓDIGO: LICO-GADPPz-001-2018).

UBICACIÓN:

PROVINCIA:	PASTAZA	RUBRO :	42
CANTÓN:	PUYO	ANEXO :	1
PARROQUIA:	FÁTIMA	DESCRIPCION :	RAZANTEO DE ZANJA E= 0.20m
ARCHIVO FOTOGRAFICO		FECHA:	1 DE JUNIO 2021 A 30 DE JUNIO 2021

RAZANTEO DE ZANJA E= 0.20m



RAZANTEO DE ZANJA E= 0.20m



CONTRATISTA

FISCALIZACIÓN







PROYECTO:		"CONSTRUCCION DE LOS HANGARES DEL GOBIERNO AUTONOMO DESCENTRALIZADO PROVINCIAL DE PASTAZA (GADPPz)-I ETAPA, PARROQUIA FÁTIMA, CANTÓN Y PROVINCIAL DE PASTAZA" (CÓDIGO: LICO-GADPPz-001-2018).	
UBICACIÓN:	PROVINCIA:	PASTAZA	RUBRO: 61
	CANTÓN:	PUYO	ANEJO: 1
	PARROQUIA:	FÁTIMA	DESCRIPCION: ENTIBADO DE ZANJA
	ARCHIVO FOTOGRAFICO	FECHA:	1 DE JUNIO 2021 A 30 DE JUNIO 2021
ENTIBADO DE ZANJA			
ENTIBADO DE ZANJA			

 CONTRATISTA

 FISCALIZACIÓN

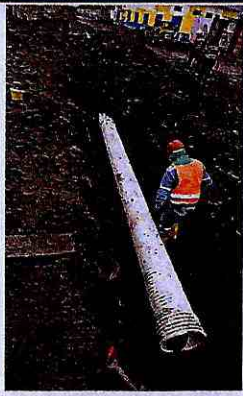

PROYECTO:		"CONSTRUCCION DE LOS HANGARES DEL GOBIERNO AUTONOMO DESCENTRALIZADO PROVINCIAL DE PASTAZA (GADPPz)-I ETAPA, PARROQUIA FÁTIMA, CANTÓN Y PROVINCIAL DE PASTAZA" (CÓDIGO: LICO-GADPPz-001-2018).			
UBICACIÓN:	PROVINCIA:	PASTAZA	RUBRO :	62	
	CANTÓN:	PUYO	ANEXO :	1	
	PARROQUIA:	FÁTIMA	DESCRIPCION :	RAZANTEO DE ZANJA E= 0.20m	
	ARCHIVO FOTOGRAFICO		FECHA:	1 DE JUNIO 2021 A 30 DE JUNIO 2021	
RAZANTEO DE ZANJA E= 0.20m					
					
RAZANTEO DE ZANJA E= 0.20m					
					



 CONTRATISTA



 FISCALIZACIÓN

FATIMA

C O N S O R C I O

PROYECTO: "CONSTRUCCION DE LOS HANGARES DEL GOBIERNO AUTONOMO DESCENTRALIZADO PROVINCIAL DE PASTAZA (GADPPz)-I ETAPA, PARROQUIA FÁTIMA, CANTÓN Y PROVINCIAL DE PASTAZA" (CÓDIGO: LICO-GADPPz-001-2018).

UBICACIÓN:	PROVINCIA:	PASTAZA	RUBRO:	120
	CANTÓN:	PUYO	ANEXO:	1
	PARROQUIA:	FÁTIMA	DESCRIPCION:	TRATAMIENTO PINTURA ESTRUCTURA ACERO A36 (FONDO+PINTURA ANTICORROSIVA), A COMPRESOR
	ARCHIVO FOTOGRÁFICO		FECHA:	1 DE JUNIO 2021 A 30 DE JUNIO 2021

TRATAMIENTO PINTURA ESTRUCTURA ACERO A36 (FONDO+PINTURA ANTICORROSIVA), A COMPRESOR

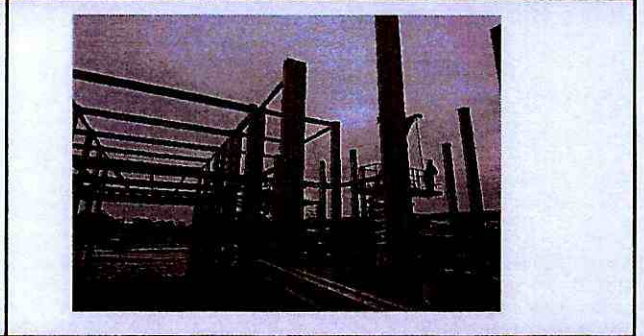

TRATAMIENTO PINTURA ESTRUCTURA ACERO A36 (FONDO+PINTURA ANTICORROSIVA), A COMPRESOR

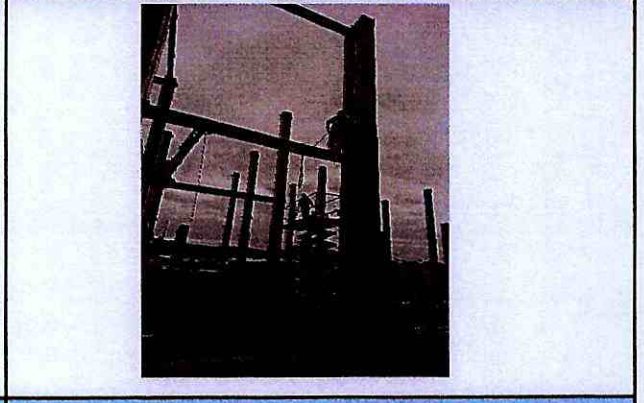

TRATAMIENTO PINTURA ESTRUCTURA ACERO A36 (FONDO+PINTURA ANTICORROSIVA), A COMPRESOR

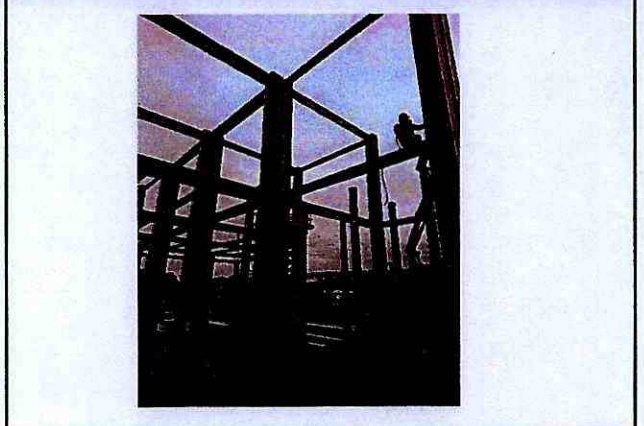
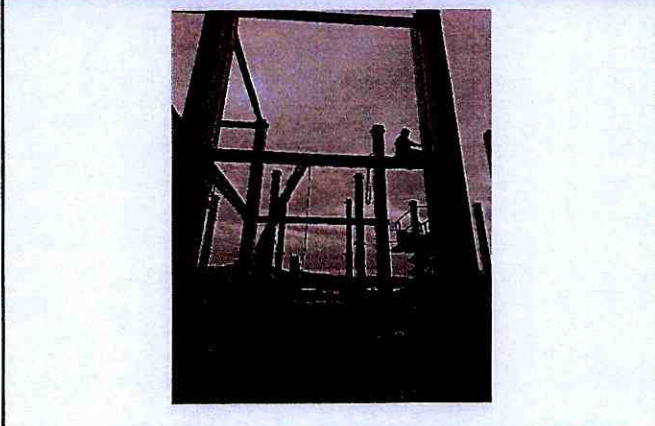

CONTRATISTA

FISCALIZACIÓN



PROYECTO: "CONSTRUCCIÓN DE LOS HANGARES DEL GOBIERNO AUTONOMO DESCENTRALIZADO PROVINCIAL DE PASTAZA (GADPPz)-I ETAPA, PARROQUIA FÁTIMA, CANTÓN Y PROVINCIAL DE PASTAZA" (CÓDIGO: LICO-GADPPz-001-2018).

UBICACIÓN:	PROVINCIA:	PASTAZA	RUBRO:	121
	CANTÓN:	PUYO	ANEXO:	1
	PARROQUIA:	FÁTIMA	DESCRIPCION:	mALLA ELECTROSOLDADA 15X15X6mm
	ARCHIVO FOTOGRAFICO	FECHA:	1 DE JUNIO 2021 A 30 DE JUNIO 2021	

mALLA ELECTROSOLDADA 15X15X6mm



mALLA ELECTROSOLDADA 15X15X6mm

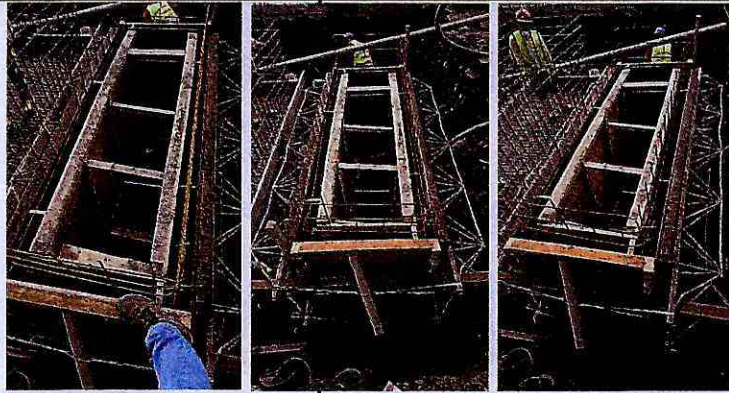

L

CONTRATISTA

[Signature]

FISCALIZACIÓN



PROYECTO:		"CONSTRUCCIÓN DE LOS HANGARES DEL GOBIERNO AUTONOMO DESCENTRALIZADO PROVINCIAL DE PASTAZA (GADPPz)-I ETAPA, PARROQUIA FÁTIMA, CANTÓN Y PROVINCIAL DE PASTAZA" (CÓDIGO: LICO-GADPPz-001-2018).		
UBICACIÓN:	PROVINCIA:	PASTAZA	RUBRO:	128
	CANTÓN:	PUYO	ANEXO:	1
	PARROQUIA:	FÁTIMA	DESCRIPCION:	PINTURA EPOXICA PISO INDUSTRIAL 3mm (2 COMONENTES)
	ARCHIVO FOTOGRÁFICO	FECHA:	1 DE JUNIO 2021 A 30 DE JUNIO 2021	

PINTURA EPOXICA PISO INDUSTRIAL 3mm (2 COMPONENTES)



CONTRATISTA

FISCALIZACIÓN



PROYECTO:		"CONSTRUCCIÓN DE LOS HANGARES DEL GOBIERNO AUTONOMO DESCENTRALIZADO PROVINCIAL DE PASTAZA (GADPPz)-I ETAPA, PARROQUIA FÁTIMA, CANTÓN Y PROVINCIAL DE PASTAZA" (CÓDIGO: LICO-GADPPz-001-2018).		
UBICACIÓN:	PROVINCIA:	PASTAZA	RUBRO:	148
	CANTÓN:	PUYO	ANEXO:	1
	PARROQUIA:	FÁTIMA	DESCRIPCION:	mAmPOSTERIA BLOQuE PESADO VIBRADO 4mPAE=15 Cm
	ARCHIVO FOTOGRÁFICO		FECHA:	1 DE JUNIO 2021 A 30 DE JUNIO 2021

mAmPOSTERIA BLOQUE PESADO VIBRADO 4mPAE=15 Cm



mAmPOSTERIA BLOQUE PESADO VIBRADO 4mPAE=15 Cm





 CONTRATISTA



 FISCALIZACIÓN



PROYECTO: "CONSTRUCCIÓN DE LOS HANGARES DEL GOBIERNO AUTONOMO DESCENTRALIZADO PROVINCIAL DE PASTAZA (GADPPz)-I ETAPA, PARROQUIA FÁTIMA, CANTÓN Y PROVINCIAL DE PASTAZA" (CÓDIGO: LICO-GADPPz-001-2018).

UBICACIÓN:	PROVINCIA:	PASTAZA	RUBRO :	150
	CANTÓN:	PUYO	ANEXO :	1
	PARROQUIA:	FÁTIMA	DESCRIPCION :	mESON H.A. F'C=180 KG/Cm2 E=7 Cm HIERRO (LAVAmANOS+mESON)
	ARCHIVO FOTOGRAFICO	FECHA:	1 DE JUNIO 2021 A 30 DE JUNIO 2021	

mESON H.A. F'C=180 KG/Cm2 E=7 Cm HIERRO (LAVAmANOS+mESON)

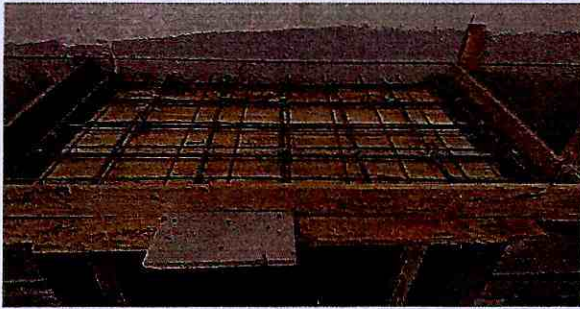

mESON H.A. F'C=180 KG/Cm2 E=7 Cm HIERRO (LAVAmANOS+mESON)

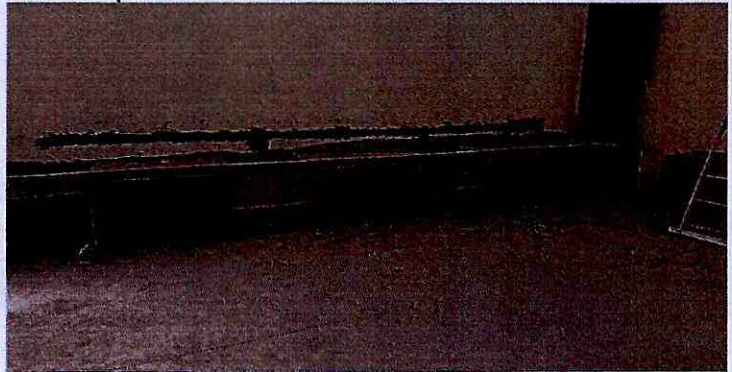
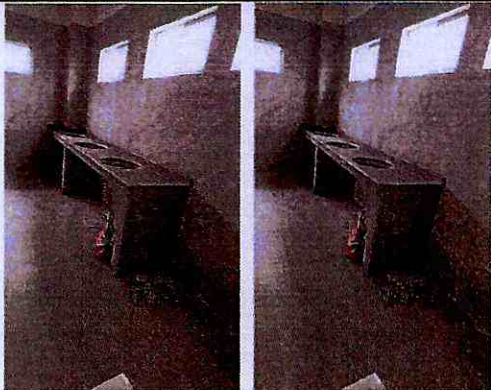

CONTRATISTA

FISCALIZACIÓN



PROYECTO: "CONSTRUCCION DE LOS HANGARES DEL GOBIERNO AUTONOMO DESCENTRALIZADO PROVINCIAL DE PASTAZA (GADPPz)-I ETAPA, PARROQUIA FÁTIMA, CANTÓN Y PROVINCIAL DE PASTAZA" (CÓDIGO: LICO-GADPPz-001-2018).

UBICACIÓN:	PROVINCIA:	PASTAZA	RUBRO:	153
	CANTÓN:	PUYO	ANEXO:	1
	PARROQUIA:	FÁTIMA	DESCRIPCION:	ENLUCCIDO VERTICAL PALETEADO MORTERO 1:3 (INTERIOR)
	ARCHIVO FOTOGRAFICO	FECHA:	1 DE JUNIO 2021 A 30 DE JUNIO 2021	

ENLUCCIDO VERTICAL PALETEADO MORTERO 1:3 (INTERIOR)





 CONTRATISTA



 FISCALIZACIÓN

PROYECTO:

"CONSTRUCCION DE LOS HANGARES DEL GOBIERNO AUTONOMO DESCENTRALIZADO PROVINCIAL DE PASTAZA (GADPPz)-I ETAPA, PARROQUIA FÁTIMA, CANTÓN Y PROVINCIAL DE PASTAZA" (CÓDIGO: LICO-GADPPz-001-2018).

UBICACIÓN:

PROVINCIA:	PASTAZA	RUBRO:	176
CANTÓN:	PUYO	ANEXO:	1
PARROQUIA:	FÁTIMA	DESCRIPCION:	PuERTA YmAmPARAALumINIOS200YVIDRIOLAmINADO E=8mm CON PIVOTE
ARCHIVO FOTOGRAFICO		FECHA:	1 DE JUNIO 2021 A 30 DE JUNIO 2021

PuERTA YmAmPARAALumINIOS200YVIDRIOLAmINADO E=8mm CON PIVOTE

PuERTA YmAmPARAALumINIOS200YVIDRIOLAmINADO E=8mm CON PIVOTE



PuERTA YmAmPARAALumINIOS200YVIDRIOLAmINADO E=8mm CON PIVOTE

PuERTA YmAmPARAALumINIOS200YVIDRIOLAmINADO E=8mm CON PIVOTE

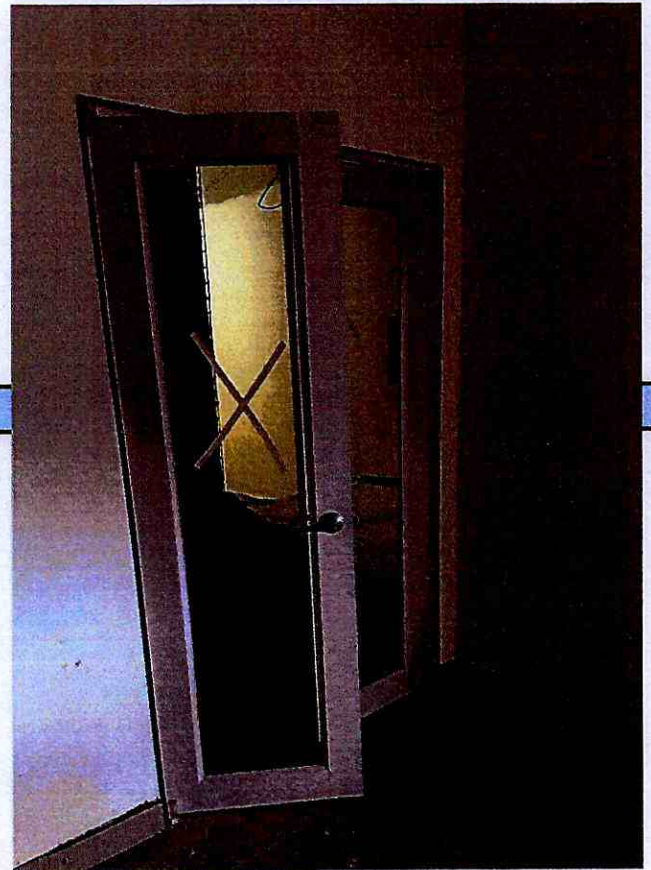
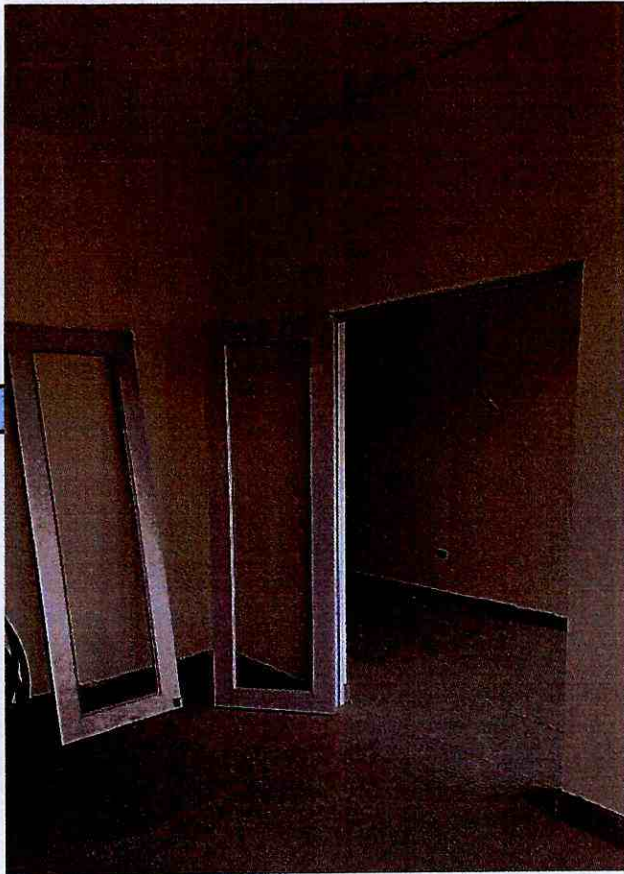

CONTRATISTA

FISCALIZACIÓN

PROYECTO:

"CONSTRUCCION DE LOS HANGARES DEL GOBIERNO AUTONOMO DESCENTRALIZADO PROVINCIAL DE PASTAZA (GADPPz)-I ETAPA, PARROQUIA FÁTIMA, CANTÓN Y PROVINCIAL DE PASTAZA" (CÓDIGO: LICO-GADPPz-001-2018).

UBICACIÓN:

PROVINCIA:	PASTAZA	RUBRO:	178
CANTÓN:	PUYO	ANEXO:	1
PARROQUIA:	FÁTIMA	DESCRIPCION:	PuERTA BATIENTE ALUMINIO Y VIDRIO FLOTADO CLARO 6mm (1.00X2.10)
ARCHIVO FOTOGRAFICO		FECHA:	1 DE JUNIO 2021 A 30 DE JUNIO 2021

Puerta batiente aluminio y vidrio flotado claro 6mm (1.00x2.10)



Puerta batiente aluminio y vidrio flotado claro 6mm (1.00x2.10)



Puerta batiente aluminio y vidrio flotado claro 6mm (1.00x2.10)

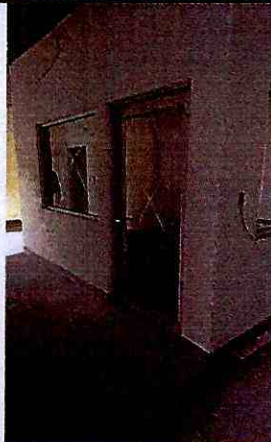

Puerta batiente aluminio y vidrio flotado claro 6mm (1.00x2.10)

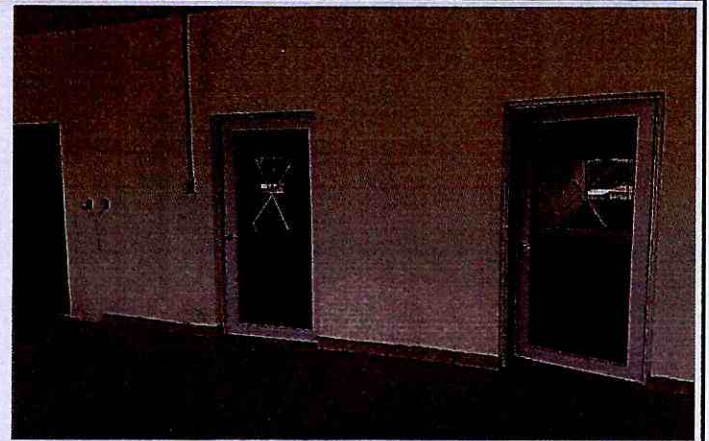

Puerta batiente aluminio y vidrio flotado claro 6mm (1.00x2.10)



Puerta batiente aluminio y vidrio flotado claro 6mm (1.00x2.10)



CONTRATISTA

FISCALIZACIÓN

PROYECTO:

"CONSTRUCCIÓN DE LOS HANGARES DEL GOBIERNO AUTONOMO DESCENTRALIZADO PROVINCIAL DE PASTAZA (GADPPz)-I ETAPA, PARROQUIA FÁTIMA, CANTÓN Y PROVINCIAL DE PASTAZA" (CÓDIGO: LICO-GADPPz-001-2018).

UBICACIÓN:

PROVINCIA:	PASTAZA	RUBRO :	179
CANTÓN:	PUYO	ANEXO :	1
PARROQUIA:	FÁTIMA	DESCRIPCION :	VENTANA CORREDIZA ALuMINIO SERIE 200-INCL. VIDRIO LAMINADO 6mm
ARCHIVO FOTOGRÁFICO		FECHA:	1 DE JUNIO 2021 A 30 DE JUNIO 2021

VENTANA CORREDIZA ALuMINIO SERIE 200-INCL. VIDRIO LAMINADO 6mm

VENTANA CORREDIZA ALuMINIO SERIE 200-INCL. VIDRIO LAMINADO 6mm

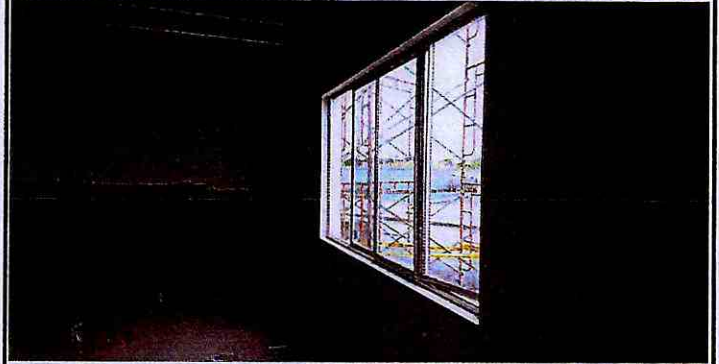
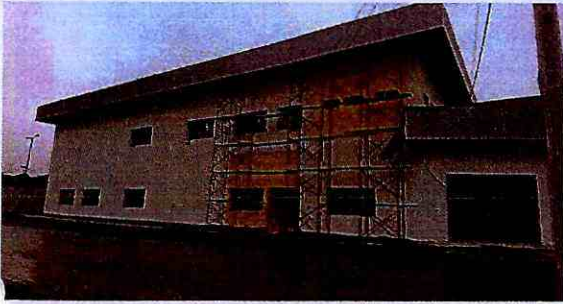

VENTANA CORREDIZA ALuMINIO SERIE 200-INCL. VIDRIO LAMINADO 6mm

VENTANA CORREDIZA ALuMINIO SERIE 200-INCL. VIDRIO LAMINADO 6mm



VENTANA CORREDIZA ALuMINIO SERIE 200-INCL. VIDRIO LAMINADO 6mm

VENTANA CORREDIZA ALuMINIO SERIE 200-INCL. VIDRIO LAMINADO 6mm



CONTRATISTA

FISCALIZACIÓN



PROYECTO: "CONSTRUCCION DE LOS HANGARES DEL GOBIERNO AUTONOMO DESCENTRALIZADO PROVINCIAL DE PASTAZA (GADPPz)-I ETAPA, PARROQUIA FÁTIMA, CANTÓN Y PROVINCIAL DE PASTAZA" (CÓDIGO: LICO-GADPPz-001-2018).

UBICACIÓN:	PROVINCIA:	PASTAZA	RUBRO:	181
	CANTÓN:	PUYO	ANEXO:	1
	PARROQUIA:	FÁTIMA	DESCRIPCION:	CIELO RASO FALSO TIPO GYPsum PARA HumEDAD-1/2"-SIN ESTuCAR
	ARCHIVO FOTOGRÁFICO		FECHA:	1 DE JUNIO 2021 A 30 DE JUNIO 2021

CIELO RASO FALSO TIPO GYPsum PARA HumEDAD-1/2"-SIN ESTuCAR



[Handwritten signature]

CONTRATISTA

[Handwritten signature]

FISCALIZACIÓN



PROYECTO:		"CONSTRUCCION DE LOS HANGARES DEL GOBIERNO AUTONOMO DESCENTRALIZADO PROVINCIAL DE PASTAZA (GADPPz)-I ETAPA, PARROQUIA FÁTIMA, CANTÓN Y PROVINCIAL DE PASTAZA" (CÓDIGO: LICO-GADPPz-001-2018).		
UBICACIÓN:	PROVINCIA:	PASTAZA	RUBRO :	182
	CANTÓN:	PUYO	ANEXO :	1
	PARROQUIA:	FÁTIMA	DESCRIPCION :	ESTUCADO DE CIELO RASO
	ARCHIVO FOTOGRÁFICO	FECHA:	1 DE JUNIO 2021 A 30 DE JUNIO 2021	
ESTUCADO DE CIELO RASO				

CONTRATISTA

FISCALIZACIÓN



PROYECTO: "CONSTRUCCION DE LOS HANGARES DEL GOBIERNO AUTONOMO DESCENTRALIZADO PROVINCIAL DE PASTAZA (GADPPz)-I ETAPA, PARROQUIA FÁTIMA, CANTÓN Y PROVINCIAL DE PASTAZA" (CÓDIGO: LICO-GADPPz-001-2018).

UBICACIÓN:	PROVINCIA:	PASTAZA	RUBRO:	185
	CANTÓN:	PUYO	ANEXO:	1
	PARROQUIA:	FÁTIMA	DESCRIPCION:	PASAmANOS PARA DISCAPACITADOS TuBO DIAm 32mm E=1.5mm EN ACERO INOXIDABLE AISI 304, ACABADO SATINADO (Juego)
	ARCHIVO FOTOGRAFICO	FECHA:	1 DE JUNIO 2021 A 30 DE JUNIO 2021	



PASAmANOS PARA DISCAPACITADOS TuBO DIAm 32mm E=1.5mm EN ACERO INOXIDABLE AISI 304, ACABADO SATINADO (Juego)



CONTRATISTA

FISCALIZACIÓN

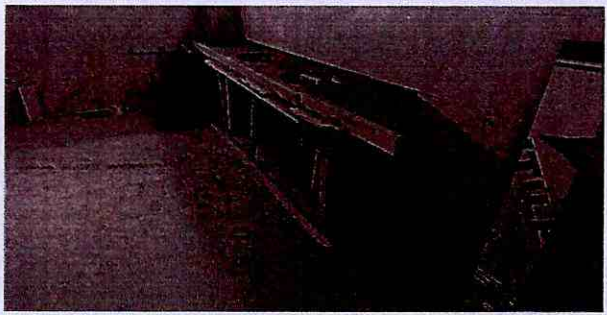

PROYECTO:		"CONSTRUCCION DE LOS HANGARES DEL GOBIERNO AUTONOMO DESCENTRALIZADO PROVINCIAL DE PASTAZA (GADPPz)-I ETAPA, PARROQUIA FÁTIMA, CANTÓN Y PROVINCIAL DE PASTAZA" (CÓDIGO: LICO-GADPPz-001-2018).		
UBICACIÓN:	PROVINCIA:	PASTAZA	RUBRO :	247
	CANTÓN:	PUYO	ANEXO:	1
	PARROQUIA:	FÁTIMA	DESCRIPCION :	mESON H.A. F'C=180 KG/Cm2 E=7 Cm HIERRO (LAVAmANOS+mESON)
	ARCHIVO FOTOGRAFICO		FECHA:	1 DE JUNIO 2021 A 30 DE JUNIO 2021
mESON H.A. F'C=180 KG/Cm2 E=7 Cm HIERRO (LAVAmANOS+mESON)				
				
				



 CONTRATISTA



 FISCALIZACIÓN



PROYECTO:

"CONSTRUCCION DE LOS HANGARES DEL GOBIERNO AUTÓNOMO DESCENTRALIZADO PROVINCIAL DE PASTAZA (GADPPz)-I ETAPA, PARROQUIA FÁTIMA, CANTÓN Y PROVINCIAL DE PASTAZA" (CÓDIGO: LICO-GADPPz-001-2018).

UBICACIÓN:

PROVINCIA:	PASTAZA	RUBRO:	248
CANTÓN:	PUYO	ANEXO:	1
PARROQUIA:	FÁTIMA	DESCRIPCION:	REVESTIMIENTO mESON GRANITO
ARCHIVO FOTGGRAFICO		FECHA:	1 DE JUNIO 2021 A 30 DE JUNIO 2021

REVESTIMIENTO mESON GRANITO

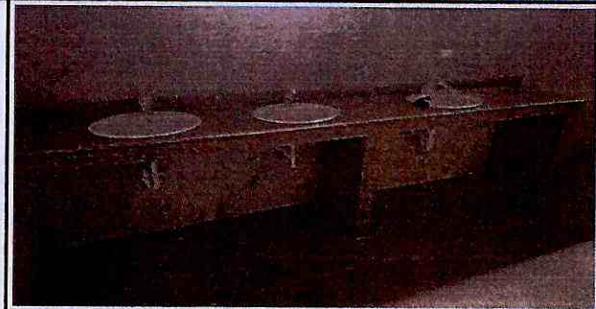
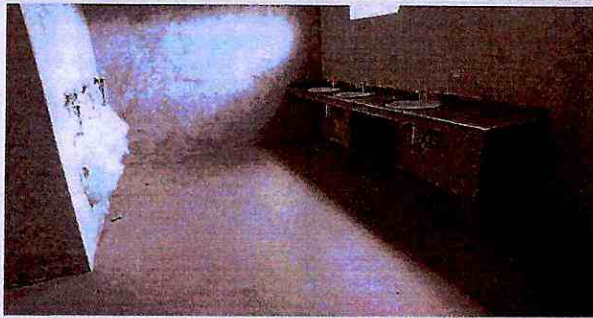

REVESTIMIENTO mESON GRANITO



CONTRATISTA



FISCALIZACIÓN



PROYECTO: "CONSTRUCCION DE LOS HANGARES DEL GOBIERNO AUTONOMO DESCENTRALIZADO PROVINCIAL DE PASTAZA (GADPPz)-I ETAPA, PARROQUIA FÁTIMA, CANTÓN Y PROVINCIAL DE PASTAZA" (CÓDIGO: LICO-GADPPz-001-2018).

UBICACIÓN:	PROVINCIA:	PASTAZA	RUBRO:	262
	CANTÓN:	PUYO	ANEXO:	1
	PARROQUIA:	FÁTIMA	DESCRIPCION:	PuERTA BATIENTE ALUMINIO Y VIDRIO FLOTADO CLARO 6mm (1.00X2.10)
	ARCHIVO FOTOGRÁFICO		FECHA:	1 DE JUNIO 2021 A 30 DE JUNIO 2021

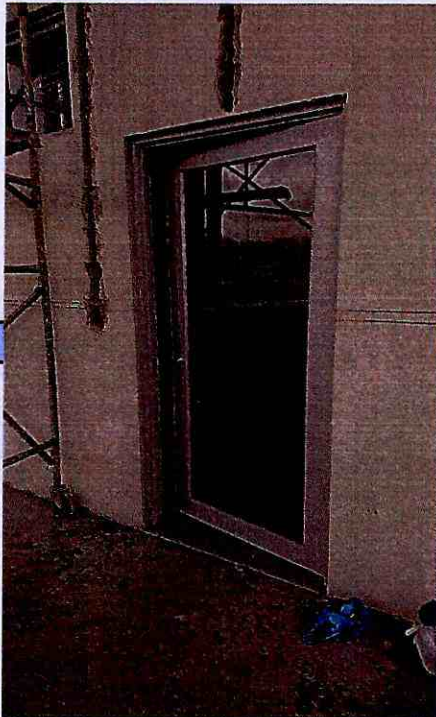
PuERTA BATIENTE ALUMINIO Y VIDRIO FLOTADO CLARO 6mm (1.00X2.10)



CONTRATISTA

FISCALIZACIÓN



PROYECTO: "CONSTRUCCION DE LOS HANGARES DEL GOBIERNO AUTÓNOMO DESCENTRALIZADO PROVINCIAL DE PASTAZA (GADPPz)-I ETAPA, PARROQUIA FÁTIMA, CANTÓN Y PROVINCIAL DE PASTAZA" (CÓDIGO: LICO-GADPPz-001-2018).

UBICACIÓN:	PROVINCIA:	PASTAZA	RUBRO:	263
	CANTÓN:	PUYO	ANEXO:	1
	PARROQUIA:	FÁTIMA	DESCRIPCION:	VENTANA CORREDIZA ALUMINIO SERIE 200-INCL. VIDRIO LAMINADO 6mm
	ARCHIVO FOTOGRAFICO	FECHA:	1 DE JUNIO 2021 A 30 DE JUNIO 2021	

VENTANA CORREDIZA ALUMINIO SERIE 200-INCL. VIDRIO LAMINADO 6mm



CONTRATISTA

FISCALIZACIÓN



PROYECTO: "CONSTRUCCIÓN DE LOS HANGARES DEL GOBIERNO AUTONOMO DESCENTRALIZADO PROVINCIAL DE PASTAZA (GADPPz)-I ETAPA, PARROQUIA FÁTIMA, CANTÓN Y PROVINCIAL DE PASTAZA" (CÓDIGO: LICO-GADPPz-001-2018).

UBICACIÓN:	PROVINCIA:	PASTAZA	RUBRO:	271
	CANTÓN:	PUYO	ANEXO:	1
	PARROQUIA:	FÁTIMA	DESCRIPCION:	DISPENSOR DE PAPEL HIGIENICO DIAm=275mm, ROLLO 70mm, ABATIBLE, ACERO INOX E=8mm, AISI 304. ACABADO S
	ARCHIVO FOTOGRÁFICO	FECHA:	1 DE JUNIO 2021 A 30 DE JUNIO 2021	

DISPENSOR DE PAPEL HIGIENICO DIAM=275mm, ROLLO 70mm, ABATIBLE, ACERO INOX E=8mm, AISI 304. ACABADO S



L

CONTRATISTA

A

FISCALIZACIÓN



PROYECTO: "CONSTRUCCION DE LOS HANGARES DEL GOBIERNO AUTONOMO DESCENTRALIZADO PROVINCIAL DE PASTAZA (GADPPz)-I ETAPA, PARROQUIA FÁTIMA, CANTÓN Y PROVINCIAL DE PASTAZA" (CÓDIGO: LICO-GADPPz-001-2018).

UBICACIÓN:	PROVINCIA:	PASTAZA	RUBRO:	272
	CANTÓN:	PUYO	ANEXO:	1
	PARROQUIA:	FÁTIMA	DESCRIPCION:	DISPENSOR DE PAPEL TOALLA 400-600 uNIDADES, 330X273X130mm, ACERO INOX E=8mm AISI 304, ACABADO SATINAD
	ARCHIVO FOTOGRAFICO		FECHA:	1 DE JUNIO 2021 A 30 DE JUNIO 2021

DISPENSOR DE PAPEL TOALLA 400-600 uNIDADES, 330X273X130mm, ACERO INOX E=8mm AISI 304, ACABADO SATINAD



DISPENSOR DE PAPEL TOALLA 400-600 uNIDADES, 330X273X130mm, ACERO INOX E=8mm AISI 304, ACABADO SATINAD



[Signature]

 CONTRATISTA

[Signature]

 FISCALIZACIÓN



PROYECTO: "CONSTRUCCIÓN DE LOS HANGARES DEL GOBIERNO AUTÓNOMO DESCENTRALIZADO PROVINCIAL DE PASTAZA (GADPPz)-I ETAPA, PARROQUIA FÁTIMA, CANTÓN Y PROVINCIAL DE PASTAZA" (CÓDIGO: LICO-GADPPz-001-2018).

UBICACIÓN:	PROVINCIA:	PASTAZA	RUBRO:	273
	CANTÓN:	PUYO	ANEXO:	1
	PARROQUIA:	FÁTIMA	DESCRIPCION:	DISPENSADOR DE JABÓN LIQUIDO ACERO INOX AISI304, ACABADO SATINADO
	ARCHIVO FOTOGRÁFICO:		FECHA:	1 DE JUNIO 2021 A 30 DE JUNIO 2021

DISPENSADOR DE JABÓN LIQUIDO ACERO INOX AISI304, ACABADO SATINADO



DISPENSADOR DE JABÓN LIQUIDO ACERO INOX AISI304, ACABADO SATINADO



[Handwritten Signature]

CONTRATISTA

[Handwritten Signature]

FISCALIZACIÓN



PROYECTO:		"CONSTRUCCION DE LOS HANGARES DEL GOBIERNO AUTÓNOMO DESCENTRALIZADO PROVINCIAL DE PASTAZA (GADPPz)-I ETAPA, PARROQUIA FÁTIMA, CANTÓN Y PROVINCIAL DE PASTAZA" (CÓDIGO: LICO-GADPPz-001-2018).		
UBICACIÓN:	PROVINCIA:	PASTAZA	RUBRO:	277
	CANTÓN:	PUYO	ANEXO:	1
	PARROQUIA:	FÁTIMA	DESCRIPCIÓN:	DUCHAS CON MEZCLADORA (CON ACCESORIOS)
	ARCHIVO FOTOGRÁFICO	FECHA:	1 DE JUNIO 2021 A 30 DE JUNIO 2021	



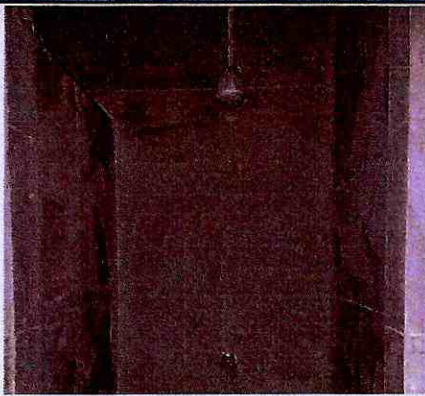
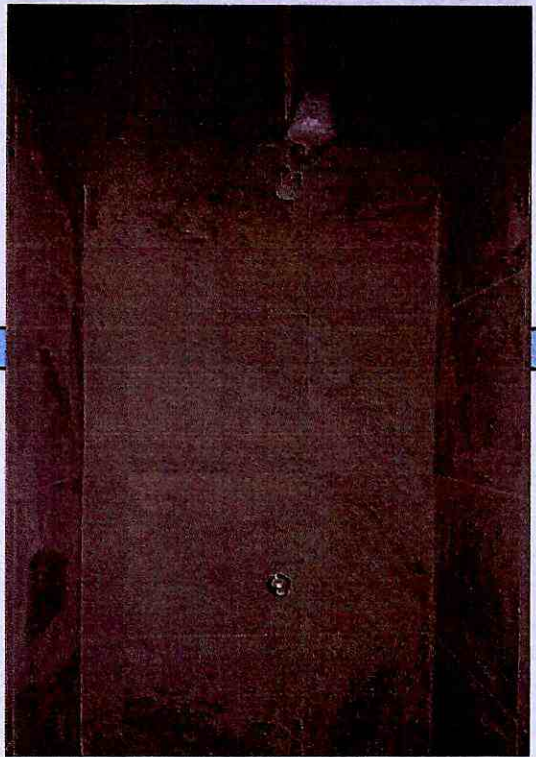



DUCHAS CON MEZCLADORA (CON ACCESORIOS)



CONTRATISTA

FISCALIZACIÓN



PROYECTO:		"CONSTRUCCIÓN DE LOS HANGARES DEL GOBIERNO AUTONOMO DESCENTRALIZADO PROVINCIAL DE PASTAZA (GADPPz)-I ETAPA, PARROQUIA FÁTIMA, CANTÓN Y PROVINCIAL DE PASTAZA" (CÓDIGO: LICO-GADPPz-001-2018).		
UBICACIÓN:	PROVINCIA:	PASTAZA	RUBRO:	530
	CANTÓN:	PUYO	ANEXO:	1
	PARROQUIA:	FÁTIMA	DESCRIPCIÓN:	TuBERIA PVC D=63 mm 1.0 mPA u/E + PRuEBA
	ARCHIVO FOTOGRÁFICO		FECHA:	1 DE JUNIO 2021 A 30 DE JUNIO 2021
TUBERIA PVC D=63 mm 1.0 mPA u/E + PRUEBA				
 		 		
 				





[Signature]

CONTRATISTA

[Signature]

FISCALIZACIÓN

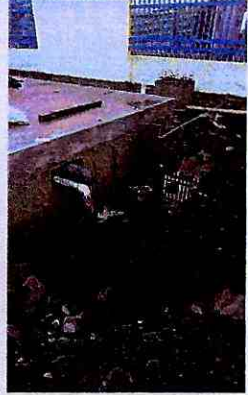
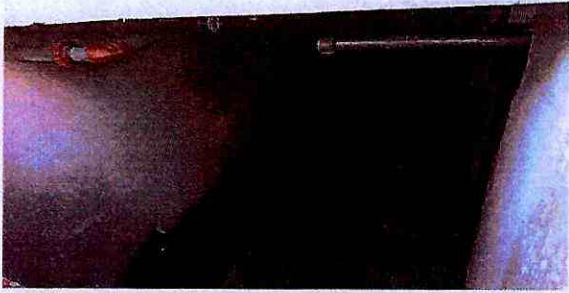

PROYECTO:		"CONSTRUCCION DE LOS HANGARES DEL GOBIERNO AUTONOMO DESCENTRALIZADO PROVINCIAL DE PASTAZA (GADPPz)-I ETAPA, PARROQUIA FÁTIMA, CANTÓN Y PROVINCIAL DE PASTAZA" (CÓDIGO: LICO-GADPPz-001-2018).		
UBICACIÓN:	PROVINCIA:	PASTAZA	RUBRO :	531
	CANTÓN:	PUYO	ANEXO :	1
	PARROQUIA:	FÁTIMA	DESCRIPCION :	CONEXION DOMICILIARIA INC.mEDIDOR,EN TuBO D=63mm
	ARCHIVO FOTOGRAFICO	FECHA:	1 DE JUNIO 2021 A 30 DE JUNIO 2021	
CONEXION DOMICILIARIA INC.mEDIDOR,EN TuBO D=63mm				
				
				



 CONTRATISTA



 FISCALIZACIÓN



PROYECTO: "CONSTRUCCION DE LOS HANGARES DEL GOBIERNO AUTONOMO DESCENTRALIZADO PROVINCIAL DE PASTAZA (GADPPz)-I ETAPA, PARROQUIA FÁTIMA, CANTÓN Y PROVINCIAL DE PASTAZA" (CÓDIGO: LICO-GADPPz-001-2018).

UBICACIÓN:	PROVINCIA:	PASTAZA	RUBRO:	537
	CANTÓN:	PUYO	ANEXO:	1
	PARROQUIA:	FÁTIMA	DESCRIPCION:	TuBERIA PVC ROSCABLE D=2" EN EDIFICACION+PRUEBA
	ARCHIVO FOTOGRAFICO	FECHA:	1 DE JUNIO 2021 A 30 DE JUNIO 2021	

TuBERIA PVC ROSCABLE D=2" EN EDIFICACION+PRUEBA

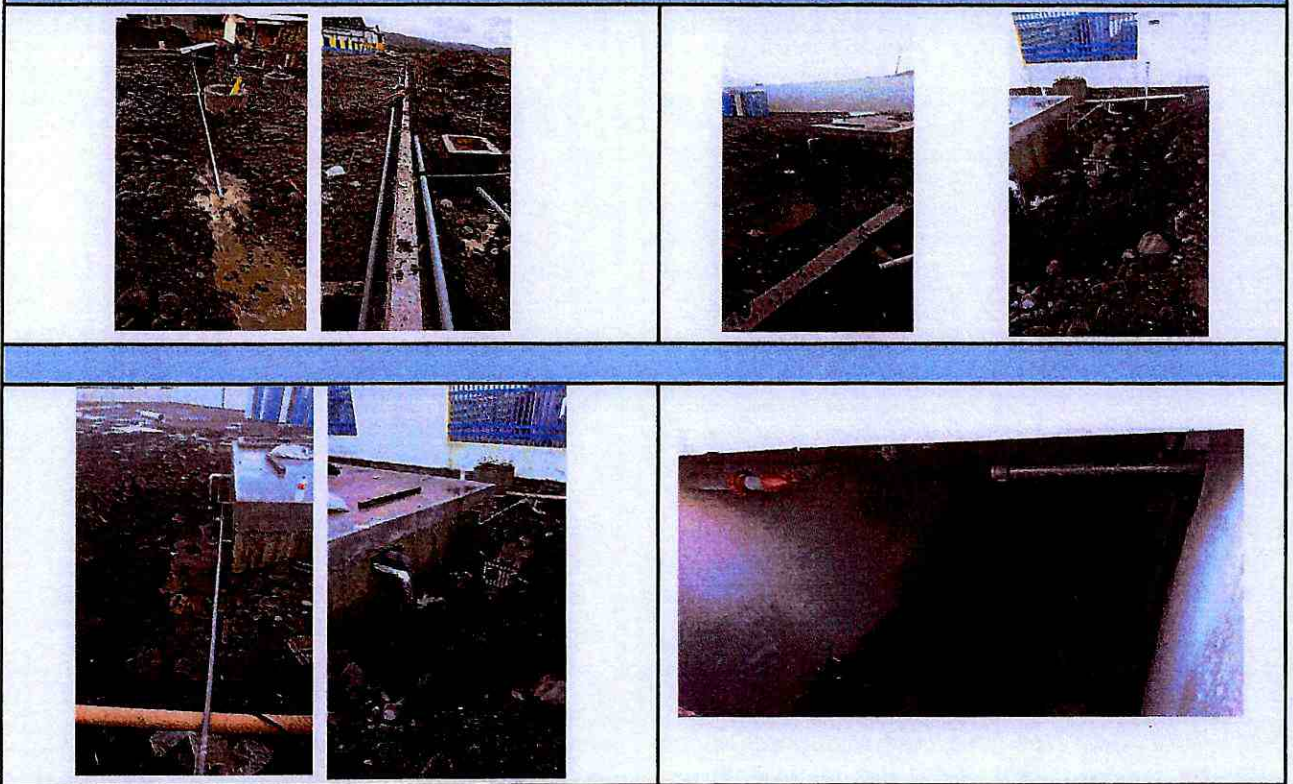

L.

CONTRATISTA

[Signature]

FISCALIZACIÓN

FATIMA

C O N S O R C I O

PROYECTO: "CONSTRUCCION DE LOS HANGARES DEL GOBIERNO AUTONOMO DESCENTRALIZADO PROVINCIAL DE PASTAZA (GADPPz)-I ETAPA, PARROQUIA FÁTIMA, CANTÓN Y PROVINCIAL DE PASTAZA" (CÓDIGO: LICO-GADPPz-001-2018).

UBICACIÓN:	PROVINCIA:	PASTAZA	RUBRO:	635
	CANTÓN:	PUYO	ANEXO:	1
	PARROQUIA:	FÁTIMA	DESCRIPCION:	HORMIGON PREMEZCLADO F'c=210 KG/Cm2 INC. ENCOFRADO + BOMBEO Y TRANSPORTE
	ARCHIVO FOTOGRÁFICO		FECHA:	1 DE JUNIO 2021 A 30 DE JUNIO 2021

HORMIGON PREMEZCLADO F'c=210 KG/Cm2 INC. ENCOFRADO + BOMBEO Y TRANSPORTE



[Handwritten Signature]

CONTRATISTA

[Handwritten Signature]

FISCALIZACIÓN



PROYECTO: "CONSTRUCCION DE LOS HANGARES DEL GOBIERNO AUTONOMO DESCENTRALIZADO PROVINCIAL DE PASTAZA (GADPPz)-I ETAPA, PARROQUIA FÁTIMA, CANTÓN Y PROVINCIAL DE PASTAZA" (CÓDIGO: LICO-GADPPz-001-2018).

UBICACIÓN:	PROVINCIA:	PASTAZA	RUBRO:	639
	CANTÓN:	PUYO	ANEXO:	1
	PARROQUIA:	FÁTIMA	DESCRIPCION:	ENLUCCIDO CON IMPERMEABILIZANTE MORTERO 1:3 (EXTERIOR)
	ARCHIVO FOTOGRÁFICO	FECHA:	1 DE JUNIO 2021 A 30 DE JUNIO 2021	

ENLUCCIDO CON IMPERMEABILIZANTE MORTERO 1:3 (EXTERIOR)

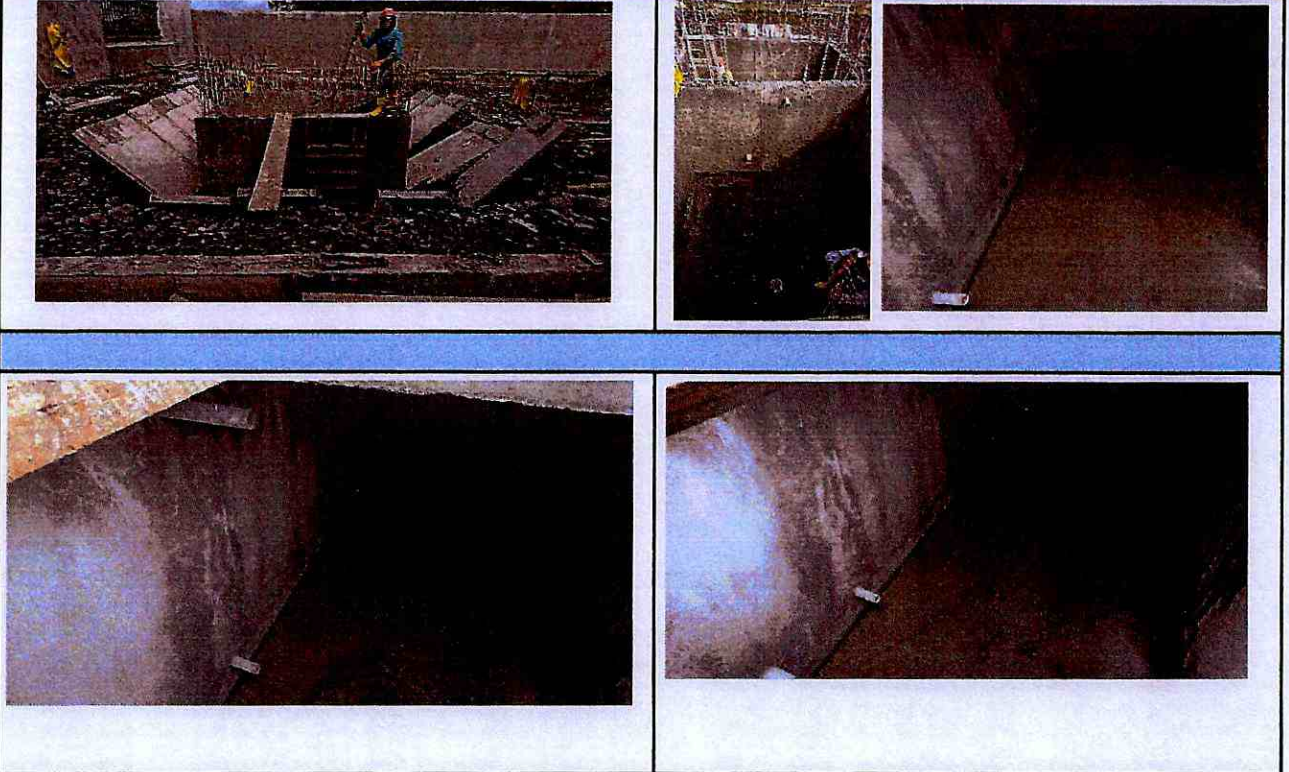





CONTRATISTA



FISCALIZACIÓN

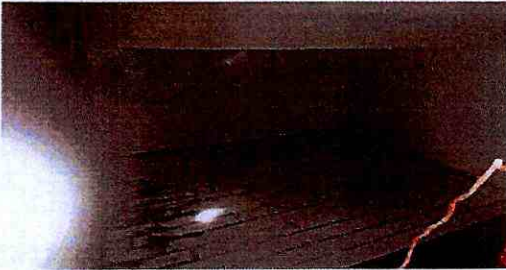

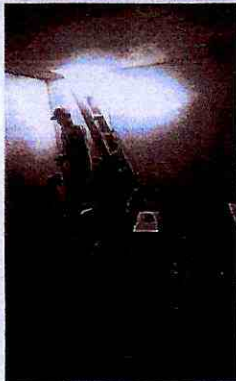
PROYECTO:		"CONSTRUCCION DE LOS HANGARES DEL GOBIERNO AUTONOMO DESCENTRALIZADO PROVINCIAL DE PASTAZA (GADPPz)-I ETAPA, PARROQUIA FÁTIMA, CANTÓN Y PROVINCIAL DE PASTAZA" (CÓDIGO: LICO-GADPPz-001-2018).			
UBICACIÓN:	PROVINCIA:	PASTAZA	RUBRO:	640	
	CANTÓN:	PUYO	ANEXO:	1	
	PARROQUIA:	FÁTIMA	DESCRIPCION:	CERÁMICA COLOR PISO Y PARED ANTIDESLIZANTE 0.30X0.30-INSTAL. Y EmP	
	ARCHIVO FOTOGRÁFICO		FECHA:	1 DE JUNIO 2021 A 30 DE JUNIO 2021	
CERÁMICA COLOR PISO Y PARED ANTIDESLIZANTE 0.30X0.30-INSTAL. Y EmP					
					
CERÁMICA COLOR PISO Y PARED ANTIDESLIZANTE 0.30X0.30-INSTAL. Y EmP					
					



 CONTRATISTA



 FISCALIZACIÓN



PROYECTO: "CONSTRUCCION DE LOS HANGARES DEL GOBIERNO AUTONOMO DESCENTRALIZADO PROVINCIAL DE PASTAZA (GADPPz)-I ETAPA, PARROQUIA FÁTIMA, CANTÓN Y PROVINCIAL DE PASTAZA" (CÓDIGO: LICO-GADPPz-001-2018).

UBICACIÓN:	PROVINCIA:	PASTAZA	RUBRO :	641
	CANTÓN:	PUYO	ANEXO :	1
	PARROQUIA:	FÁTIMA	DESCRIPCION :	PINTURA DE CAUCHO SATINADO COLOR (2 MANOS) INTER. <Guía ImAGEN CORPORATIVA GADPPz>
	ARCHIVO FOTOGRÁFICO		FECHA:	1 DE JUNIO 2021 A 30 DE JUNIO 2021

PINTURA DE CAUCHO SATINADO COLOR (2 MANOS) INTER. <Guía ImAGEN CORPORATIVA GADPPz>





 CONTRATISTA



 FISCALIZACIÓN



PROYECTO:		"CONSTRUCCION DE LOS HANGARES DEL GOBIERNO AUTONOMO DESCENTRALIZADO PROVINCIAL DE PASTAZA (GADPPz)-I ETAPA, PARROQUIA FÁTIMA, CANTÓN Y PROVINCIAL DE PASTAZA" (CÓDIGO: LICO-GADPPz-001-2018).		
UBICACIÓN:	PROVINCIA:	PASTAZA	RUBRO:	877
	CANTÓN:	PUYO	ANEXO:	1
	PARROQUIA:	FÁTIMA	DESCRIPCION:	CERAmICA COLOR PISO Y PARED ANTIDESLIZANTE 0.30X0.30-INSTAL. Y EmP
	ARCHIVO FOTOGRÁFICO		FECHA:	1 DE JUNIO 2021 A 30 DE JUNIO 2021

CERAmICA COLOR PISO Y PARED ANTIDESLIZANTE 0.30X0.30-INSTAL. Y EmP

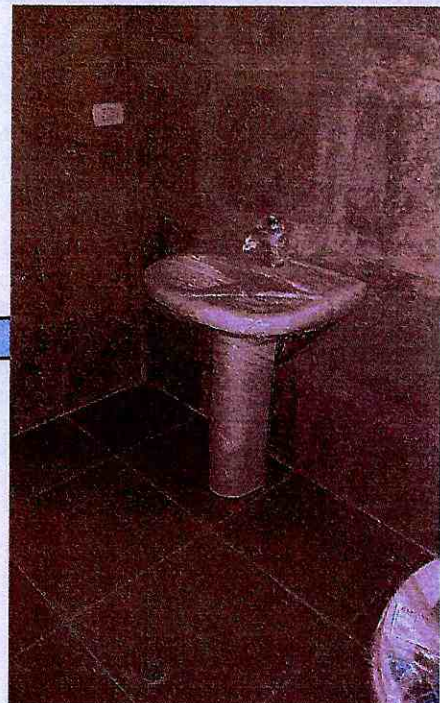

CONTRATISTA

FISCALIZACIÓN



PROYECTO: "CONSTRUCCIÓN DE LOS HANGARES DEL GOBIERNO AUTONOMO DESCENTRALIZADO PROVINCIAL DE PASTAZA (GADPPz)-I ETAPA, PARROQUIA FÁTIMA, CANTÓN Y PROVINCIAL DE PASTAZA" (CÓDIGO: LICO-GADPPz-001-2018).

UBICACIÓN:	PROVINCIA:	PASTAZA	RUBRO :	887
	CANTÓN:	PUYO	ANEXO :	1
	PARROQUIA:	FÁTIMA	DESCRIPCION :	PICADO Y RESANADO DE mAmPOSTERIA PARA INSTALACIONES
	ARCHIVO FOTOGRÁFICO	FECHA:	1 DE JUNIO 2021 A 30 DE JUNIO 2021	

PICADO Y RESANADO DE mAmPOSTERIA PARA INSTALACIONES



PICADO Y RESANADO DE mAmPOSTERIA PARA INSTALACIONES



CONTRATISTA

FISCALIZACIÓN



PROYECTO:

"CONSTRUCCION DE LOS HANGARES DEL GOBIERNO AUTONOMO DESCENTRALIZADO PROVINCIAL DE PASTAZA (GADPPz)-I ETAPA, PARROQUIA FÁTIMA, CANTÓN Y PROVINCIAL DE PASTAZA" (CÓDIGO: LICO-GADPPz-001-2018).

UBICACIÓN:

PROVINCIA:	PASTAZA	RUBRO :	894
CANTÓN:	PUYO	ANEXO :	1
PARROQUIA:	FÁTIMA	DESCRIPCIÓN :	PuERTA TAMBORADA 70cm, ESQUELETO CANELO, mDF 9mm -LACADA-DISEÑO CORPORATIVO
ARCHIVO FOTOGRÁFICO		FECHA:	1 DE JUNIO 2021 A 30 DE JUNIO 2021

PuERTA TAMBORADA 70cm, ESQUELETO CANELO, mDF 9mm -LACADA-DISEÑO CORPORATIVO





ESQUELETO CANELO, mDF 9mm



CONTRATISTA

FISCALIZACIÓN



PROYECTO:		"CONSTRUCCION DE LOS HANGARES DEL GOBIERNO AUTONOMO DESCENTRALIZADO PROVINCIAL DE PASTAZA (GADPPz)-I ETAPA, PARROQUIA FÁTIMA, CANTÓN Y PROVINCIAL DE PASTAZA" (CÓDIGO: LICO-GADPPz-001-2018).		
UBICACIÓN:	PROVINCIA:	PASTAZA	RUBRO:	896
	CANTÓN:	PUYO	ANEXO:	1
	PARROQUIA:	FÁTIMA	DESCRIPCION:	INODORO BLANCO (CON ACCESORIOS)
	ARCHIVO FOTOGRÁFICO		FECHA:	1 DE JUNIO 2021 A 30 DE JUNIO 2021
INODORO BLANCO (CON ACCESORIOS)				
				
INODORO BLANCO (CON ACCESORIOS)				
				

CONTRATISTA

FISCALIZACIÓN



PROYECTO: "CONSTRUCCION DE LOS HANGARES DEL GOBIERNO AUTONOMO DESCENTRALIZADO PROVINCIAL DE PASTAZA (GADPPz)-I ETAPA, PARROQUIA FÁTIMA, CANTÓN Y PROVINCIAL DE PASTAZA" (CÓDIGO: LICO-GADPPz-001-2018).

UBICACIÓN:	PROVINCIA:	PASTAZA	RUBRO:	897
	CANTÓN:	PUYO	ANEXO:	1
	PARROQUIA:	FÁTIMA	DESCRIPCION:	LAVABO BLANCO (CON ACCESORIOS)
	ARCHIVO FOTOGRÁFICO		FECHA:	1 DE JUNIO 2021 A 30 DE JUNIO 2021

LAVABO BLANCO (CON ACCESORIOS)

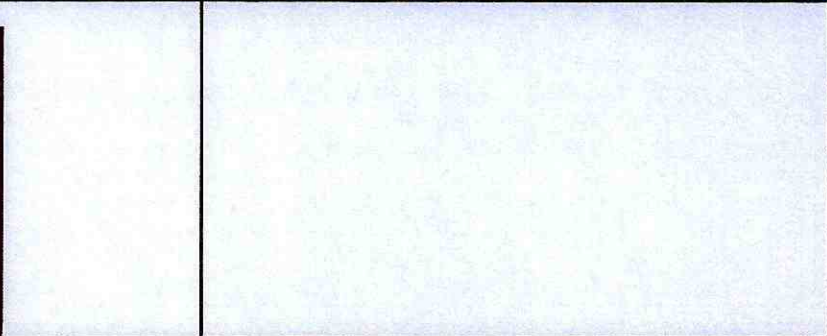

LAVABO BLANCO (CON ACCESORIOS)



[Signature]

 CONTRATISTA

[Signature]

 FISCALIZACIÓN



PROYECTO:		"CONSTRUCCIÓN DE LOS HANGARES DEL GOBIERNO AUTONOMO DESCENTRALIZADO PROVINCIAL DE PASTAZA (GADPPz)-I ETAPA, PARROQUIA FÁTIMA, CANTÓN Y PROVINCIAL DE PASTAZA" (CÓDIGO: LICO-GADPPz-001-2018).		
UBICACIÓN:	PROVINCIA:	PASTAZA	RUBRO:	899
	CANTÓN:	PUYO	ANEXO:	1
	PARROQUIA:	FÁTIMA	DESCRIPCION:	ARREGLO Y LimPIEZA (INCLUYE DESALOJO)
	ARCHIVO FOTOGRÁFICO		FECHA:	1 DE JUNIO 2021 A 30 DE JUNIO 2021
ARREGLO Y LimPIEZA (INCLUYE DESALOJO)				
ARREGLO Y LimPIEZA (INCLUYE DESALOJO)				

CONTRATISTA

FISCALIZACIÓN



PROYECTO: "CONSTRUCCIÓN DE LOS HANGARES DEL GOBIERNO AUTONOMO DESCENTRALIZADO PROVINCIAL DE PASTAZA (GADPPz)-I ETAPA, PARROQUIA FÁTIMA, CANTÓN Y PROVINCIAL DE PASTAZA" (CÓDIGO: LICO-GADPPz-001-2018).

UBICACIÓN:	PROVINCIA:	PASTAZA	RUBRO:	901
	CANTÓN:	PUYO	ANEXO:	1
	PARROQUIA:	FÁTIMA	DESCRIPCION:	EXCAVACION SIN CLASIFICAR (A mAQUINA)
	ARCHIVO FOTOGRAFICO	FECHA:	1 DE JUNIO 2021 A 30 DE JUNIO 2021	

EXCAVACION SIN CLASIFICAR (A mAQUINA)



EXCAVACION SIN CLASIFICAR (A mAQUINA)





 CONTRATISTA



 FISCALIZACIÓN



PROYECTO: "CONSTRUCCIÓN DE LOS HANGARES DEL GOBIERNO AUTÓNOMO DESCENTRALIZADO PROVINCIAL DE PASTAZA (GADPPz)-I ETAPA, PARROQUIA FÁTIMA, CANTÓN Y PROVINCIAL DE PASTAZA" (CÓDIGO: LICO-GADPPz-001-2018).

UBICACIÓN:	PROVINCIA:	PASTAZA	RUBRO :	903
	CANTÓN:	PUYO	ANEXO :	1
	PARROQUIA:	FÁTIMA	DESCRIPCION :	RELLENO COMpACTADO A mAQUINA CON LASTRE TNm=8" (EN CAPAS DE 20 Cm)
	ARCHIVO FOTOGRÁFICO	FECHA:	1 DE JUNIO 2021 A 30 DE JUNIO 2021	

RELLENO COMpACTADO A mAQUINA CON LASTRE TNm=8" (EN CAPAS DE 20 Cm)



RELLENO COMpACTADO A mAQUINA CON LASTRE TNm=8" (EN CAPAS DE 20 Cm)



[Signature]

CONTRATISTA

[Signature]

FISCALIZACIÓN



PROYECTO: "CONSTRUCCIÓN DE LOS HANGARES DEL GOBIERNO AUTONOMO DESCENTRALIZADO PROVINCIAL DE PASTAZA (GADPPz)-I ETAPA, PARROQUIA FÁTIMA, CANTÓN Y PROVINCIAL DE PASTAZA" (CÓDIGO: LICO-GADPPz-001-2018).

UBICACIÓN:	PROVINCIA:	PASTAZA	RUBRO :	904
	CANTÓN:	PUYO	ANEXO :	1
	PARROQUIA:	FÁTIMA	DESCRIPCION :	DESALOJO MECANICO VOLQUETA TIERRA/ESCOmbROS
	ARCHIVO FOTOGRAFICO		FECHA:	1 DE JUNIO 2021 A 30 DE JUNIO 2021

DESALOJO MECANICO VOLQUETA TIERRA/ESCOmbROS



DESALOJO MECANICO VOLQUETA TIERRA/ESCOmbROS



CONTRATISTA

FISCALIZACIÓN



PROYECTO:		"CONSTRUCCION DE LOS HANGARES DEL GOBIERNO AUTONOMO DESCENTRALIZADO PROVINCIAL DE PASTAZA (GADPPz)-I ETAPA, PARROQUIA FÁTIMA, CANTÓN Y PROVINCIAL DE PASTAZA" (CÓDIGO: LICO-GADPPz-001-2018).		
UBICACIÓN:	PROVINCIA:	PASTAZA	RUBRO:	905
	CANTÓN:	PUYO	ANEXO:	1
	PARROQUIA:	FÁTIMA	DESCRIPCION:	HORMIGON PREmEZCLADO REPLANTILLO F'C=180 KG/Cm2 INC. BOMBEO Y TRANSPORTE
	ARCHIVO FOTOGRÁFICO		FECHA:	1 DE JUNIO 2021 A 30 DE JUNIO 2021

HORMIGON PREmEZCLADO REPLANTILLO F'C=180 KG/Cm2 INC. BOMBEO Y TRANSPORTE



HORMIGON PREmEZCLADO REPLANTILLO F'C=180 KG/Cm2 INC. BOMBEO Y TRANSPORTE





CONTRATISTA



FISCALIZACIÓN



PROYECTO:

"CONSTRUCCION DE LOS HANGARES DEL GOBIERNO AUTONOMO DESCENTRALIZADO PROVINCIAL DE PASTAZA (GADPPz)-I ETAPA, PARROQUIA FÁTIMA, CANTÓN Y PROVINCIAL DE PASTAZA" (CÓDIGO: LICO-GADPPz-001-2018).

UBICACIÓN:

PROVINCIA:	PASTAZA	RUBRO:	907
CANTÓN:	PUYO	ANEXO:	1
PARROQUIA:	FÁTIMA	DESCRIPCION:	HORmIGON PREmEZCLADO CADENAS F'C=280 KG/Cm2 INC. ENCOFRADO INC. CONBEO Y TRANSPORTE
ARCHIVO FOTOGRAFICO		FECHA:	1 DE JUNIO 2021 A 30 DE JUNIO 2021

HORmIGON PREmEZCLADO CADENAS F'C=280 KG/Cm2 INC. ENCOFRADO INC. CONBEO Y TRANSPORTE



HORmIGON PREmEZCLADO CADENAS F'C=280 KG/Cm2 INC. ENCOFRADO INC. CONBEO Y TRANSPORTE

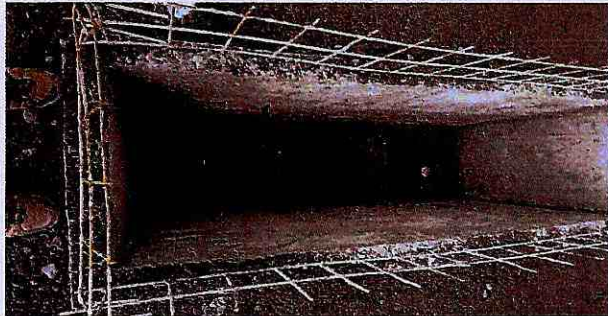

CONTRATISTA

FISCALIZACIÓN



PROYECTO: "CONSTRUCCION DE LOS HANGARES DEL GOBIERNO AUTONOMO DESCENTRALIZADO PROVINCIAL DE PASTAZA (GADPPz)-I ETAPA, PARROQUIA FÁTIMA, CANTÓN Y PROVINCIAL DE PASTAZA" (CÓDIGO: LICO-GADPPz-001-2018).

UBICACIÓN:	PROVINCIA:	PASTAZA	RUBRO:	908
	CANTÓN:	PUYO	ANEXO:	1
	PARROQUIA:	FÁTIMA	DESCRIPCION:	HORmIGON PREmEZCLADO COLUmNAS F'C=280 KG/Cm2 INC. ENCOFRADO, BOMBA Y TRANSPORTE
	ARCHIVO FOTOGRÁFICO		FECHA:	1 DE JUNIO 2021 A 30 DE JUNIO 2021

HORmIGON PREmEZCLADO COLUmNAS F'C=280 KG/Cm2 INC. ENCOFRADO, BOMBA Y TRANSPORTE



HORmIGON PREmEZCLADO COLUmNAS F'C=280 KG/Cm2 INC. ENCOFRADO, BOMBA Y TRANSPORTE

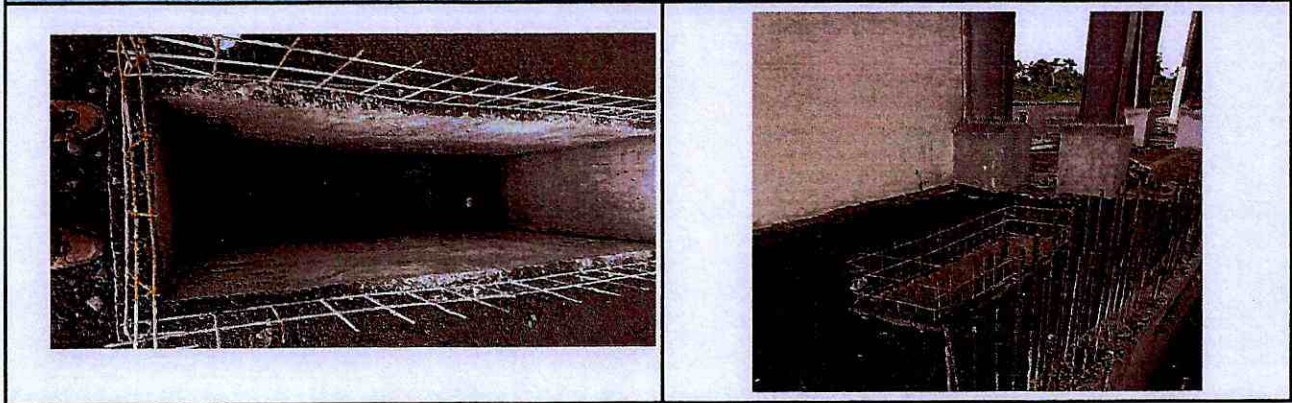

[Signature]

 CONTRATISTA

[Signature]

 FISCALIZACIÓN



PROYECTO:		"CONSTRUCCIÓN DE LOS HANGARES DEL GOBIERNO AUTÓNOMO DESCENTRALIZADO PROVINCIAL DE PASTAZA (GADPPz)-I ETAPA, PARROQUIA FÁTIMA, CANTÓN Y PROVINCIAL DE PASTAZA" (CÓDIGO: LICO-GADPPz-001-2018).		
UBICACIÓN:	PROVINCIA:	PASTAZA	RUBRO:	910
	CANTÓN:	PUYO	ANEXO:	1
	PARROQUIA:	FÁTIMA	DESCRIPCIÓN:	ACERO DE REFUERZO F'Y= 4200 Kg/Cm2
	ARCHIVO FOTOGRÁFICO		FECHA:	1 DE JUNIO 2021 A 30 DE JUNIO 2021

ACERO DE REFUERZO F'Y= 4200 Kg/Cm2



ACERO DE REFUERZO F'Y= 4200 Kg/Cm2



 CONTRATISTA

 FISCALIZACIÓN



PROYECTO: "CONSTRUCCIÓN DE LOS HANGARES DEL GOBIERNO AUTONOMO DESCENTRALIZADO PROVINCIAL DE PASTAZA (GADPPz)-I ETAPA, PARROQUIA FÁTIMA, CANTÓN Y PROVINCIAL DE PASTAZA" (CÓDIGO: LICO-GADPPz-001-2018).

UBICACIÓN:	PROVINCIA:	PASTAZA	RUBRO :	911
	CANTÓN:	PUYO	ANEXO :	1
	PARROQUIA:	FÁTIMA	DESCRIPCION :	PERFIL ESTRUCTURAL ACERO ASTM A (36, 572, 325,193,108) (PROY. MONTAJE GRUA)
	ARCHIVO FOTOGRAFICO	FECHA:	1 DE JUNIO 2021 A 30 DE JUNIO 2021	

PERFIL ESTRUCTURAL ACERO ASTM A (36, 572, 325,193,108) (PROY. MONTAJE GRUA)



PERFIL ESTRUCTURAL ACERO ASTM A (36, 572, 325,193,108) (PROY. MONTAJE GRUA)



[Signature]

CONTRATISTA

[Signature]
FISCALIZACIÓN



PROYECTO: "CONSTRUCCION DE LOS HANGARES DEL GOBIERNO AUTONOMO DESCENTRALIZADO PROVINCIAL DE PASTAZA (GADPPz)-I ETAPA, PARROQUIA FÁTIMA, CANTÓN Y PROVINCIAL DE PASTAZA" (CÓDIGO: LICO-GADPPz-001-2018).

UBICACIÓN:	PROVINCIA:	PASTAZA	RUBRO:	912
	CANTÓN:	PUYO	ANEXO:	1
	PARROQUIA:	FÁTIMA	DESCRIPCION:	TRATAMIENTO PINTURA ESTRUCTURA ACERO A36 (FONDO+PINTURA ANTICORROSIVA), A COMPRESOR
	ARCHIVO FOTOGRÁFICO		FECHA:	1 DE JUNIO 2021 A 30 DE JUNIO 2021

TRATAMIENTO PINTURA ESTRUCTURA ACERO A36 (FONDO+PINTURA ANTICORROSIVA), A COMPRESOR



TRATAMIENTO PINTURA ESTRUCTURA ACERO A36 (FONDO+PINTURA ANTICORROSIVA), A COMPRESOR



CONTRATISTA

FISCALIZACIÓN



PROYECTO: "CONSTRUCCIÓN DE LOS HANGARES DEL GOBIERNO AUTÓNOMO DESCENTRALIZADO PROVINCIAL DE PASTAZA (GADPPz)-I ETAPA, PARROQUIA FÁTIMA, CANTÓN Y PROVINCIAL DE PASTAZA" (CÓDIGO: LICO-GADPPz-001-2018).

UBICACIÓN:	PROVINCIA:	PASTAZA	RUBRO :	246
	CANTÓN:	PUYO	ANEXO :	1
	PARROQUIA:	FÁTIMA	DESCRIPCION :	PICADO Y RESANADO DE mAmPOSTERIA PARA INSTALACIONES
	ARCHIVO FOTOGRÁFICO		FECHA:	1 DE JUNIO 2021 A 30 DE JUNIO 2021

PICADO Y RESANADO DE mAmPOSTERIA PARA INSTALACIONES



PICADO Y RESANADO DE mAmPOSTERIA PARA INSTALACIONES

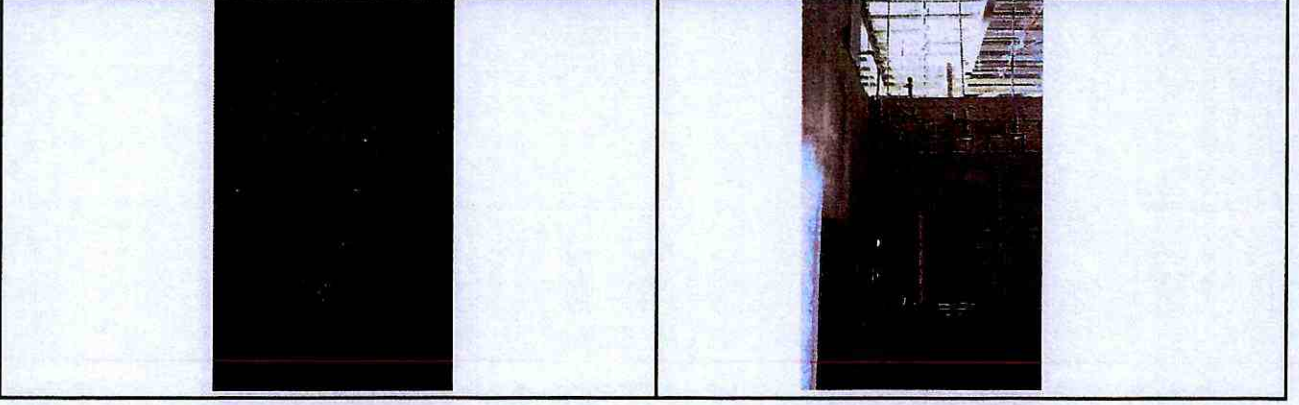

[Handwritten Signature]

CONTRATISTA

[Handwritten Signature]
FISCALIZACIÓN



PROYECTO: "CONSTRUCCIÓN DE LOS HANGARES DEL GOBIERNO AUTONOMO DESCENTRALIZADO PROVINCIAL DE PASTAZA (GADPPz)-I ETAPA, PARROQUIA FÁTIMA, CANTÓN Y PROVINCIAL DE PASTAZA" (CÓDIGO: LICO-GADPPz-001-2018).

UBICACIÓN:	PROVINCIA:	PASTAZA	RUBRO :	247
	CANTÓN:	PUYO	ANEXO :	1
	PARROQUIA:	FÁTIMA	DESCRIPCION :	mESON H.A. F'C=180 KG/Cm2 E=7 Cm HIERRO (LAVAmANOS+mESON)
	ARCHIVO FOTOGRÁFICO		FECHA:	1 DE JUNIO 2021 A 30 DE JUNIO 2021

mESON H.A. F'C=180 KG/Cm2 E=7 Cm HIERRO (LAVAmANOS+mESON)

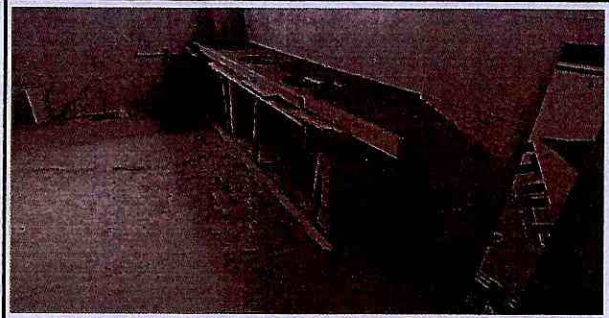

mESON H.A. F'C=180 KG/Cm2 E=7 Cm HIERRO (LAVAmANOS+mESON)





 CONTRATISTA



 FISCALIZACIÓN



PROYECTO: "CONSTRUCCION DE LOS HANGARES DEL GOBIERNO AUTONOMO DESCENTRALIZADO PROVINCIAL DE PASTAZA (GADPPz)-I ETAPA, PARROQUIA FÁTIMA, CANTÓN Y PROVINCIAL DE PASTAZA" (CÓDIGO: LICO-GADPPz-001-2018).

UBICACIÓN:	PROVINCIA:	PASTAZA	RUBRO:	248
	CANTÓN:	PUYO	ANEXO:	1
	PARROQUIA:	FÁTIMA	DESCRIPCION:	REVESTIMIENTO mESON GRANITO
	ARCHIVO FOTOGRÁFICO	FECHA:	1 DE JUNIO 2021 A 30 DE JUNIO 2021	

REVESTIMIENTO mESON GRANITO

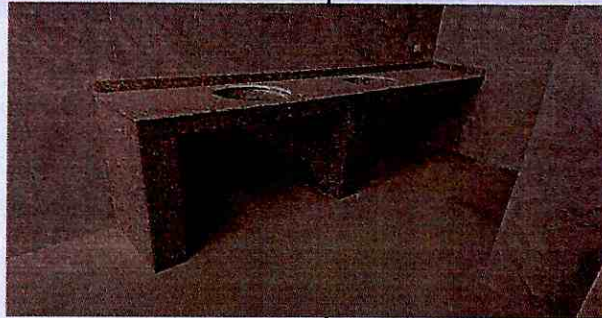

REVESTIMIENTO mESON GRANITO

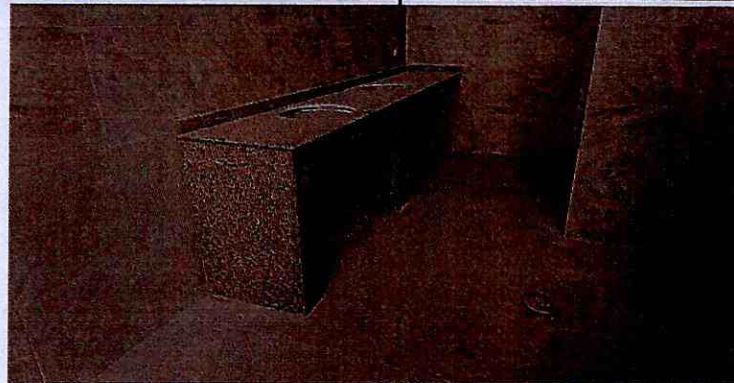

CONTRATISTA

FISCALIZACIÓN



PROYECTO: "CONSTRUCCION DE LOS HANGARES DEL GOBIERNO AUTONOMO DESCENTRALIZADO PROVINCIAL DE PASTAZA (GADPPz)-I ETAPA, PARROQUIA FÁTIMA, CANTÓN Y PROVINCIAL DE PASTAZA" (CÓDIGO: LICO-GADPPz-001-2018).

UBICACIÓN:	PROVINCIA:	PASTAZA	RUBRO :	259
	CANTÓN:	PUYO	ANEXO :	1
	PARROQUIA:	FÁTIMA	DESCRIPCION :	PuERTA mETÁLICA PANELADA TOOL GALV. 2mm , INC. CERRADuRA, BISAGRAS Y PINTuRA
	ARCHIVO FOTOGRÁFICO		FECHA:	1 DE JUNIO 2021 A 30 DE JUNIO 2021

PuERTA mETÁLICA PANELADA TOOL GALV. 2mm , INC. CERRADuRA, BISAGRAS Y PINTuRA



PuERTA mETÁLICA PANELADA TOOL GALV. 2mm , INC. CERRADuRA, BISAGRAS Y PINTuRA





 CONTRATISTA



 FISCALIZACIÓN



PROYECTO: "CONSTRUCCION DE LOS HANGARES DEL GOBIERNO AUTONOMO DESCENTRALIZADO PROVINCIAL DE PASTAZA (GADPPz)-I ETAPA, PARROQUIA FÁTIMA, CANTÓN Y PROVINCIAL DE PASTAZA" (CÓDIGO: LICO-GADPPz-001-2018).

UBICACIÓN:	PROVINCIA:	PASTAZA	RUBRO:	260
	CANTÓN:	PUYO	ANEXO:	1
	PARROQUIA:	FÁTIMA	DESCRIPCION:	PuERTAS mODuLARES, TAmBORADAS PARA BAÑOS EN ACERO INOXIDABLE E=1mm AISI 304, INCLUYE ESTRuCTuRA Y HER
	ARCHIVO FOTOGRÁFICO	FECHA:	1 DE JUNIO 2021 A 30 DE JUNIO 2021	

PuERTAS mODuLARES, TAmBORADAS PARA BAÑOS EN ACERO INOXIDABLE E=1mm AISI 304, INCLUYE ESTRuCTuRA Y HER

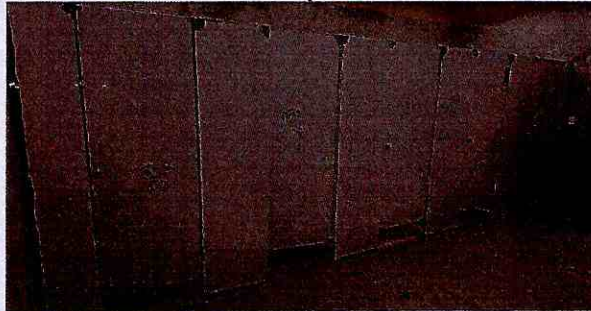

PuERTAS mODuLARES, TAmBORADAS PARA BAÑOS EN ACERO INOXIDABLE E=1mm AISI 304, INCLUYE ESTRuCTuRA Y HER



CONTRATISTA

FISCALIZACIÓN



PROYECTO:		"CONSTRUCCION DE LOS HANGARES DEL GOBIERNO AUTONOMO DESCENTRALIZADO PROVINCIAL DE PASTAZA (GADPPz)-I ETAPA, PARROQUIA FÁTIMA, CANTÓN Y PROVINCIAL DE PASTAZA" (CÓDIGO: LICO-GADPPz-001-2018).		
UBICACIÓN:	PROVINCIA:	PASTAZA	RUBRO:	RN-4
	CANTÓN:	PUYO	ANEXO:	1
	PARROQUIA:	FÁTIMA	DESCRIPCION:	ACERAS DE H.S. F'C=180KG/CM2 E=7CM, ESCOBILLADA.
	ARCHIVO FOTOGRAFICO		FECHA:	1 DE JUNIO 2021 A 30 DE JUNIO 2021

ACERAS DE H.S. F'C=180KG/CM2 E=7CM, ESCOBILLADA.

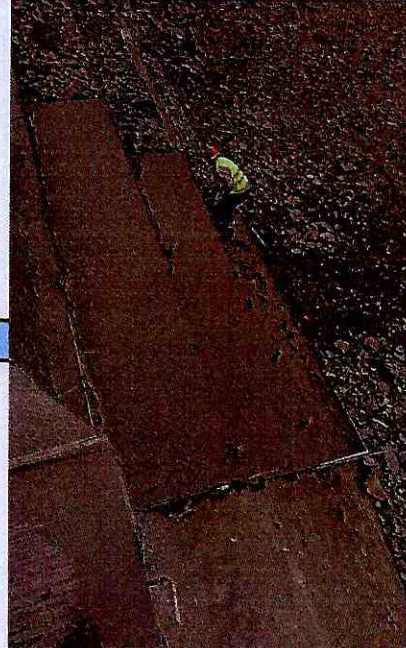
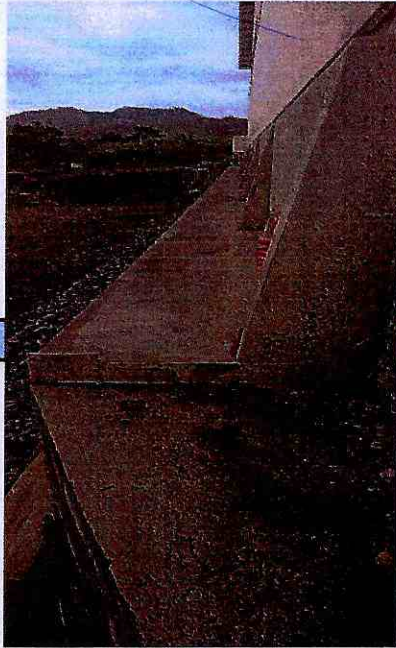



 CONTRATISTA



 FISCALIZACIÓN



PROYECTO:		"CONSTRUCCION DE LOS HANGARES DEL GOBIERNO AUTONOMO DESCENTRALIZADO PROVINCIAL DE PASTAZA (GADPPz)-I ETAPA, PARROQUIA FÁTIMA, CANTÓN Y PROVINCIAL DE PASTAZA" (CÓDIGO: LICO-GADPPz-001-2018).		
UBICACIÓN:	PROVINCIA:	PASTAZA	RUBRO:	RN-7
	CANTÓN:	PUYO	ANEXO:	1
	PARROQUIA:	FÁTIMA	DESCRIPCION:	SUMINISTRO E INSTALACIÓN DE MOTOR ELÉCTRICO DE 500KG EN PUERTA DE INGRESO DE CERRAMIENTO
	ARCHIVO FOTOGRÁFICO		FECHA:	1 DE JUNIO 2021 A 30 DE JUNIO 2021
SUMINISTRO E INSTALACIÓN DE MOTOR ELÉCTRICO DE 500KG EN PUERTA DE INGRESO DE CERRAMIENTO				



Stateurop Motorline Slide 1500 en puerta corredera industrial www.vicape.com

CONTRATISTA

FISCALIZACIÓN



PROYECTO: "CONSTRUCCION DE LOS HANGARES DEL GOBIERNO AUTONOMO DESCENTRALIZADO PROVINCIAL DE PASTAZA (GADPPz)-I ETAPA, PARROQUIA FÁTIMA, CANTÓN Y PROVINCIAL DE PASTAZA" (CÓDIGO: LICO-GADPPz-001-2018).				
UBICACIÓN:	PROVINCIA:	PASTAZA	RUBRO:	RN-9
	CANTÓN:	PUYO	ANEXO:	1
	PARROQUIA:	FÁTIMA	DESCRIPCION:	TOPES PARA ESTACIONAMIENTO H.S = 180 KG/CM2 . INCLUYE PINTURA REFLECTIVA
	ARCHIVO FOTOGRAFICO		FECHA:	1 DE JUNIO 2021 A 30 DE JUNIO 2021
TOPES PARA ESTACIONAMIENTO H.S = 180 KG/CM2 . INCLUYE PINTURA REFLECTIVA				
				

CONTRATISTA

FISCALIZACIÓN



PROYECTO: "CONSTRUCCION DE LOS HANGARES DEL GOBIERNO AUTONOMO DESCENTRALIZADO PROVINCIAL DE PASTAZA (GADPPz)-I ETAPA, PARROQUIA FÁTIMA, CANTÓN Y PROVINCIAL DE PASTAZA" (CÓDIGO: LICO-GADPPz-001-2018).

UBICACIÓN:	PROVINCIA:	PASTAZA	RUBRO:	RN-11
	CANTÓN:	PUYO	ANEXO:	1
	PARROQUIA:	FÁTIMA	DESCRIPCIÓN:	PLANTAS ORNAMENTALES
	ARCHIVO FOTOGRÁFICO		FECHA:	1 DE JUNIO 2021 A 30 DE JUNIO 2021

PLANTAS ORNAMENTALES



PLANTAS ORNAMENTALES



L

CONTRATISTA

[Signature]

FISCALIZACIÓN



PROYECTO:		"CONSTRUCCION DE LOS HANGARES DEL GOBIERNO AUTONOMO DESCENTRALIZADO PROVINCIAL DE PASTAZA (GADPPz)-I ETAPA, PARROQUIA FÁTIMA, CANTÓN Y PROVINCIAL DE PASTAZA" (CÓDIGO: LICO-GADPPz-001-2018).		
UBICACIÓN:	PROVINCIA:	PASTAZA	RUBRO:	RN-12
	CANTÓN:	PUYO	ANEXO:	1
	PARROQUIA:	FÁTIMA	DESCRIPCIÓN:	PALMERAS BOTELLAS ENANAS
	ARCHIVO FOTOGRÁFICO		FECHA:	1 DE JUNIO 2021 A 30 DE JUNIO 2021

PALMERAS BOTELLAS ENANAS





PALMERAS BOTELLAS ENANAS





CONTRATISTA

FISCALIZACIÓN

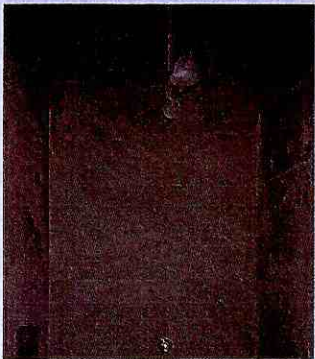

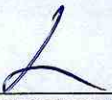
PROYECTO:		"CONSTRUCCION DE LOS HANGARES DEL GOBIERNO AUTONOMO DESCENTRALIZADO PROVINCIAL DE PASTAZA (GADPPz)-I ETAPA, PARROQUIA FÁTIMA, CANTÓN Y PROVINCIAL DE PASTAZA" (CÓDIGO: LICO-GADPPz-001-2018).			
UBICACIÓN:	PROVINCIA:	PASTAZA	RUBRO:	RN-17	
	CANTÓN:	PUYO	ANEXO:	1	
	PARROQUIA:	FÁTIMA	DESCRIPCION:	DUCHA ELÉCTRICA 110 V	
	ARCHIVO FOTOGRÁFICO		FECHA:	1 DE JUNIO 2021 A 30 DE JUNIO 2021	
DUCHA ELÉCTRICA 110 V					
					
DUCHA ELÉCTRICA 110 V					
					



 CONTRATISTA



 FISCALIZACIÓN



PROYECTO:		"CONSTRUCCION DE LOS HANGARES DEL GOBIERNO AUTONOMO DESCENTRALIZADO PROVINCIAL DE PASTAZA (GADPPz)-I ETAPA, PARROQUIA FÁTIMA, CANTÓN Y PROVINCIAL DE PASTAZA" (CÓDIGO: LICO-GADPPz-001-2018).		
UBICACIÓN:	PROVINCIA:	PASTAZA	RUBRO:	RN-18
	CANTÓN:	PUYO	ANEXO:	1
	PARROQUIA:	FÁTIMA	DESCRIPCION:	LLAVE DE DUCHA
	ARCHIVO FOTOGRAFICO		FECHA:	1 DE JUNIO 2021 A 30 DE JUNIO 2021

LLAVE DE DUCHA



LLAVE DE DUCHA

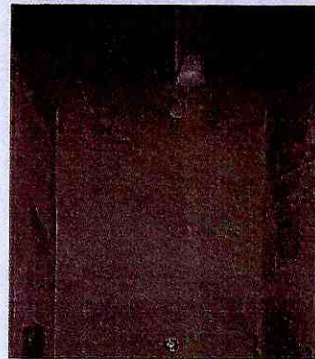



 CONTRATISTA



 FISCALIZACIÓN



PROYECTO:		"CONSTRUCCIÓN DE LOS HANGARES DEL GOBIERNO AUTONOMO DESCENTRALIZADO PROVINCIAL DE PASTAZA (GADPPz)-I ETAPA, PARROQUIA FÁTIMA, CANTÓN Y PROVINCIAL DE PASTAZA" (CÓDIGO: LICO-GADPPz-001-2018).		
UBICACIÓN:	PROVINCIA:	PASTAZA	RUBRO:	RN-19
	CANTÓN:	PUYO	ANEXO:	1
	PARROQUIA:	FÁTIMA	DESCRIPCION:	REJILLAS DE PISO 50 MM
	ARCHIVO FOTOGRAFICO		FECHA:	1 DE JUNIO 2021 A 30 DE JUNIO 2021

REJILLAS DE PISO 50 MM

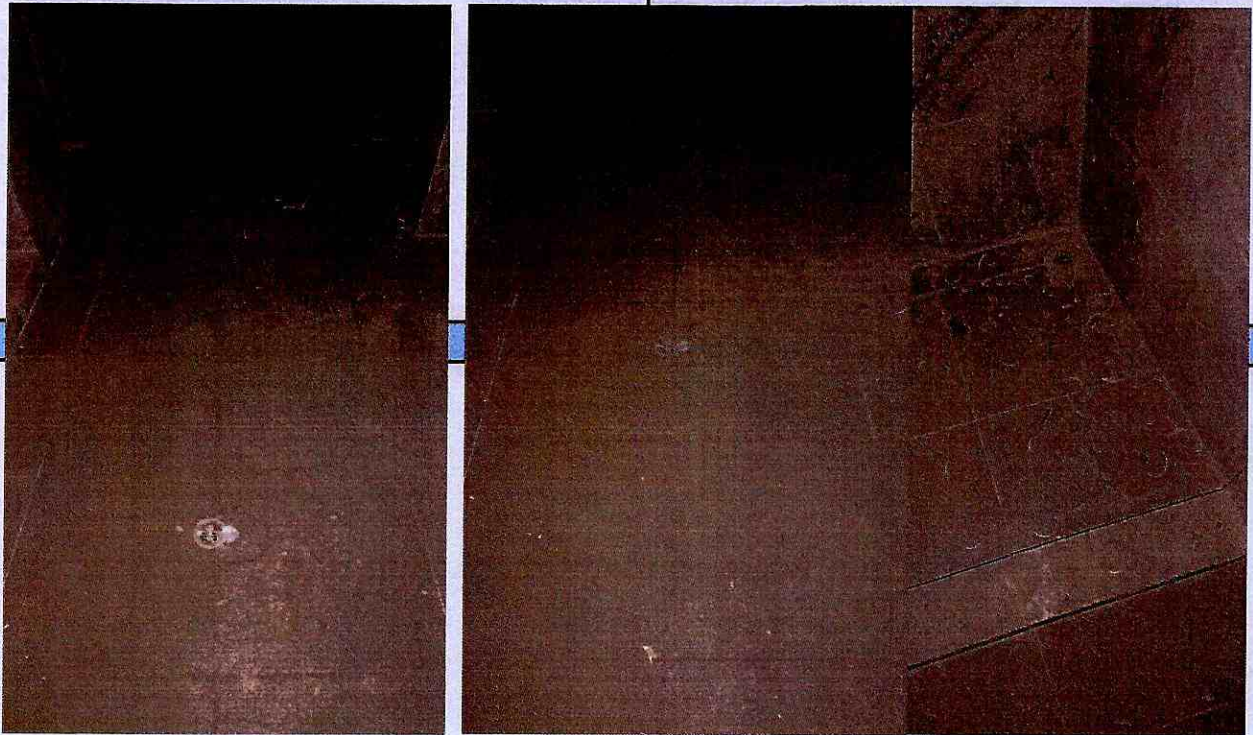

CONTRATISTA

FISCALIZACIÓN



PROYECTO: "CONSTRUCCION DE LOS HANGARES DEL GOBIERNO AUTONOMO DESCENTRALIZADO PROVINCIAL DE PASTAZA (GADPPz)-I ETAPA, PARROQUIA FÁTIMA, CANTÓN Y PROVINCIAL DE PASTAZA" (CÓDIGO: LICO-GADPPz-001-2018).

UBICACIÓN:	PROVINCIA:	PASTAZA	RUBRO:	RN-20
	CANTÓN:	PUYO	ANEXO:	1
	PARROQUIA:	FÁTIMA	DESCRIPCIÓN:	SUMIDERO DE CUBIERTA DE 110MM INCLUYE REJILLA TIPO CÚPULA
	ARCHIVO FOTOGRAFICO		FECHA:	1 DE JUNIO 2021 A 30 DE JUNIO 2021

SUMIDERO DE CUBIERTA DE 110MM INCLUYE REJILLA TIPO CÚPULA



SUMIDERO DE CUBIERTA DE 110MM INCLUYE REJILLA TIPO CÚPULA







CONTRATISTA



FISCALIZACIÓN



PROYECTO:		"CONSTRUCCION DE LOS HANGARES DEL GOBIERNO AUTONOMO DESCENTRALIZADO PROVINCIAL DE PASTAZA (GADPPz)-I ETAPA, PARROQUIA FÁTIMA, CANTÓN Y PROVINCIAL DE PASTAZA" (CÓDIGO: LICO-GADPPz-001-2018).			
UBICACIÓN:	PROVINCIA:	PASTAZA	RUBRO:	RN-21	
	CANTÓN:	PUYO	ANEXO:	1	
	PARROQUIA:	FÁTIMA	DESCRIPCION:	BORDILLO PARA TINETA DE BAÑO REVESTIDA CON CERÁMICA (0,10MX0,15M)	
	ARCHIVO FOTOGRÁFICO		FECHA:	1 DE JUNIO 2021 A 30 DE JUNIO 2021	
BORDILLO PARA TINETA DE BAÑO REVESTIDA CON CERÁMICA (0,10MX0,15M)					
					
					



 CONTRATISTA



 FISCALIZACIÓN



PROYECTO: "CONSTRUCCION DE LOS HANGARES DEL GOBIERNO AUTONOMO DESCENTRALIZADO PROVINCIAL DE PASTAZA (GADPPz)-I ETAPA, PARROQUIA FÁTIMA, CANTÓN Y PROVINCIAL DE PASTAZA" (CÓDIGO: LICO-GADPPz-001-2018).

UBICACIÓN:	PROVINCIA:	PASTAZA	RUBRO :	RN-57
	CANTÓN:	PUYO	ANEXO :	1
	PARROQUIA:	FÁTIMA	DESCRIPCION :	CERRAMIENTO TuBO H.G. 2 "-mALLA ELECTROSOLDADA 10X10X6mm, INC. PINTuRA A COmPRESOR
	ARCHIVO FOTOGRAFICO		FECHA:	1 DE JUNIO 2021 A 30 DE JUNIO 2021

CERRAMIENTO TuBO H.G. 2 "-mALLA ELECTROSOLDADA 10X10X6mm, INC. PINTuRA A COmPRESOR



CERRAMIENTO TuBO H.G. 2 "-mALLA ELECTROSOLDADA 10X10X6mm, INC. PINTuRA A COmPRESOR





 CONTRATISTA



 FISCALIZACIÓN



PROYECTO: "CONSTRUCCIÓN DE LOS HANGARES DEL GOBIERNO AUTONOMO DESCENTRALIZADO PROVINCIAL DE PASTAZA (GADPPz)-I ETAPA, PARROQUIA FÁTIMA, CANTÓN Y PROVINCIAL DE PASTAZA" (CÓDIGO: LICO-GADPPz-001-2018).

UBICACIÓN:	PROVINCIA:	PASTAZA	RUBRO :	RN-58
	CANTÓN:	PUYO	ANEXO :	1
	PARROQUIA:	FÁTIMA	DESCRIPCION :	CERRAMIENTO VERJA DE TuBO HG 2" Y TuBO RECT 80X40X2, INC. PINTURA ComPRESOR
	ARCHIVO FOTOGRÁFICO		FECHA:	1 DE JUNIO 2021 A 30 DE JUNIO 2021

CERRAMIENTO VERJA DE TuBO HG 2" Y TuBO RECT 80X40X2, INC. PINTURA ComPRESOR



CERRAMIENTO VERJA DE TuBO HG 2" Y TuBO RECT 80X40X2, INC. PINTURA ComPRESOR

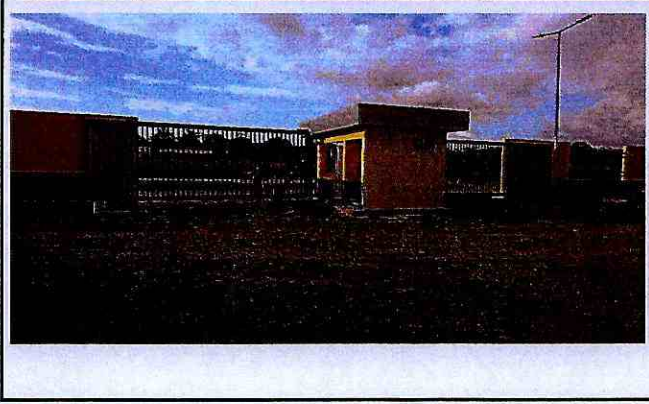

CONTRATISTA

FISCALIZACIÓN



PROYECTO:

"CONSTRUCCION DE LOS HANGARES DEL GOBIERNO AUTONOMO DESCENTRALIZADO PROVINCIAL DE PASTAZA (GADPPz)-I ETAPA, PARROQUIA FÁTIMA, CANTÓN Y PROVINCIAL DE PASTAZA" (CÓDIGO: LICO-GADPPz-001-2018).

UBICACIÓN:

PROVINCIA:	PASTAZA	RUBRO :	336
CANTÓN:	PUYO	ANEXO :	1
PARROQUIA:	FÁTIMA	DESCRIPCION :	LuminARIA LED 24W/120 VOLTIOS
ARCHIVO FOTOGRÁFICO	FECHA:	1 DE JUNIO 2021 A 30 DE JUNIO 2021	

LuminARIA LED 24W/120 VOLTIOS



LuminARIA LED 24W/120 VOLTIOS

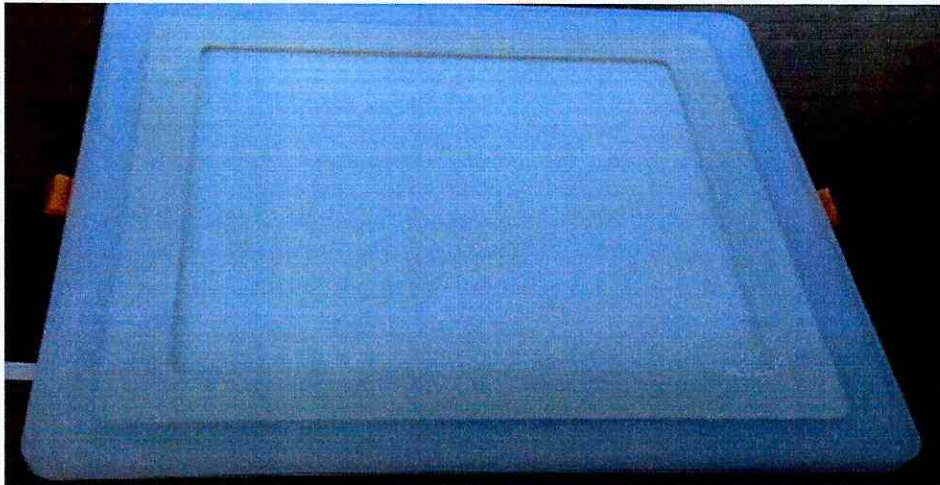

CONTRATISTA

FISCALIZACIÓN



PROYECTO:

"CONSTRUCCION DE LOS HANGARES DEL GOBIERNO AUTONOMO DESCENTRALIZADO PROVINCIAL DE PASTAZA (GADPPz)-I ETAPA, PARROQUIA FÁTIMA, CANTÓN Y PROVINCIAL DE PASTAZA" (CÓDIGO: LICO-GADPPz-001-2018).

UBICACIÓN:

PROVINCIA:	PASTAZA	RUBRO :	340 373
CANTÓN:	PUYO	ANEXO :	1
PARROQUIA:	FÁTIMA	DESCRIPCION :	TuBERIA EmT 1/2 PuLGADA
ARCHIVO FOTOGRÁFICO		FECHA:	1 DE JUNIO 2021 A 30 DE JUNIO 2021

TuBERIA EmT 1/2 PuLGADA

TuBERIA EmT 1/2 PuLGADA

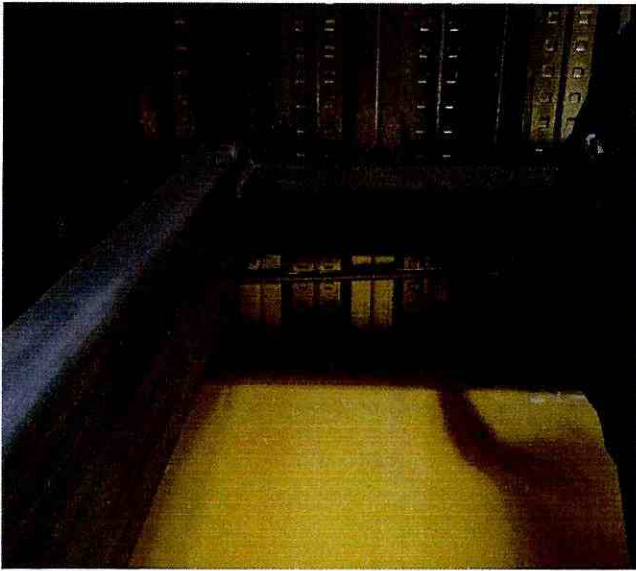

TuBERIA EmT 1/2 PuLGADA

TuBERIA EmT 1/2 PuLGADA



CONTRATISTA

FISCALIZACIÓN

PROYECTO:

"CONSTRUCCION DE LOS HANGARES DEL GOBIERNO AUTONOMO DESCENTRALIZADO PROVINCIAL DE PASTAZA (GADPPz)-I ETAPA, PARROQUIA FÁTIMA, CANTÓN Y PROVINCIAL DE PASTAZA" (CÓDIGO: LICO-GADPPz-001-2018).

UBICACIÓN:

PROVINCIA:	PASTAZA	RUBRO :	341 374
CANTÓN:	PUYO	ANEXO :	1
PARROQUIA:	FÁTIMA	DESCRIPCION :	uNION EmT 1/2 PuLGADA
ARCHIVO FOTOGRAFICO	FECHA:	1 DE JUNIO 2021 A 30 DE JUNIO 2021	

uNION EmT 1/2 PuLGADA



uNION EmT 1/2 PuLGADA



CONTRATISTA

FISCALIZACIÓN

PROYECTO:

"CONSTRUCCION DE LOS HANGARES DEL GOBIERNO AUTONOMO DESCENTRALIZADO PROVINCIAL DE PASTAZA (GADPPz)-I ETAPA, PARROQUIA FÁTIMA, CANTÓN Y PROVINCIAL DE PASTAZA" (CÓDIGO: LICO-GADPPz-001-2018).

UBICACIÓN:

PROVINCIA:	PASTAZA	RUBRO :	342 375
CANTÓN:	PUYO	ANEXO :	1
PARROQUIA:	FÁTIMA	DESCRIPCION :	CONECTOR EmT 1/2 PuLGADA
ARCHIVO FOTOGRÁFICO	FECHA:	1 DE JUNIO 2021 A 30 DE JUNIO 2021	

CONECTOR EmT 1/2 PuLGADA



34

CONECTOR EmT 1/2 PuLGADA

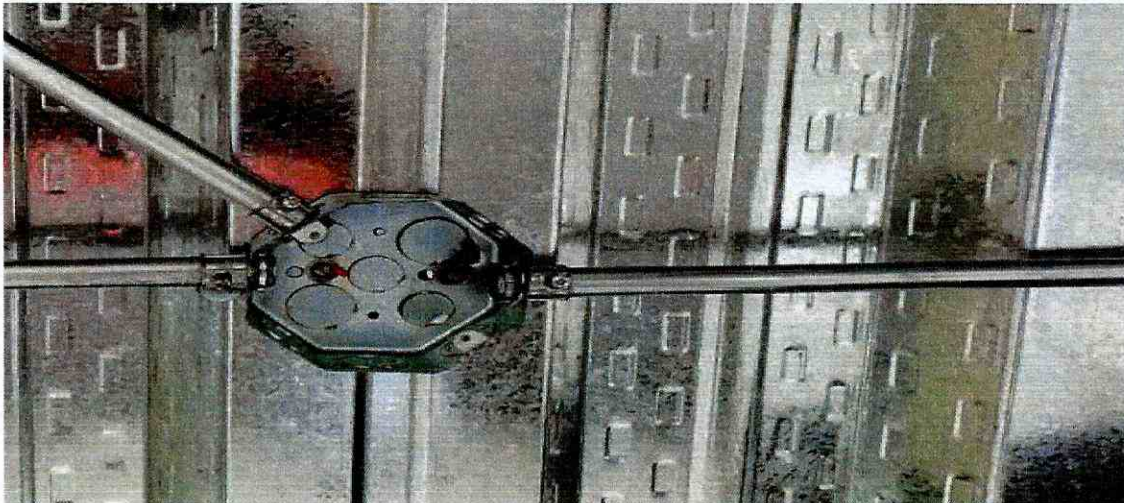

CONTRATISTA



FISCALIZACIÓN



PROYECTO:

"CONSTRUCCION DE LOS HANGARES DEL GOBIERNO AUTONOMO DESCENTRALIZADO PROVINCIAL DE PASTAZA (GADPPz)-I ETAPA, PARROQUIA FÁTIMA, CANTÓN Y PROVINCIAL DE PASTAZA" (CÓDIGO: LICO-GADPPz-001-2018).

UBICACIÓN:

PROVINCIA:	PASTAZA	RUBRO :	343 376
CANTÓN:	PUYO	ANEXO :	1
PARROQUIA:	FÁTIMA	DESCRIPCION :	FIJACION DE TUBOS EN LOZA CON GRAPA METALICA EmT 1/2 PuLGADA
ARCHIVO FOTOGRAFICO	FECHA:	1 DE JUNIO 2021 A 30 DE JUNIO 2021	

FIJACION DE TUBOS EN LOZA CON GRAPA METALICA EmT 1/2 PuLGADA

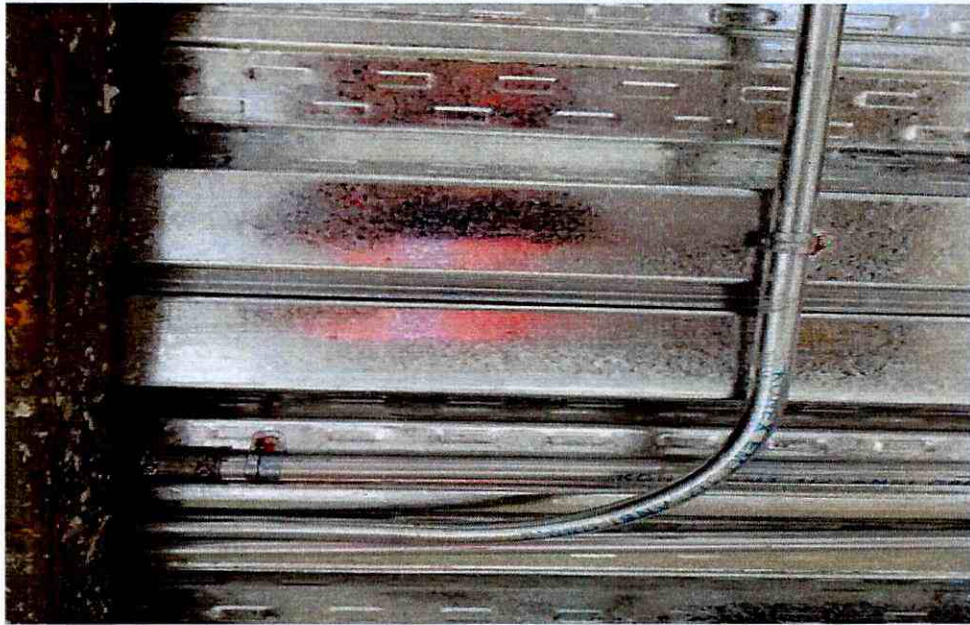

FIJACION DE TUBOS EN LOZA CON GRAPA METALICA EmT 1/2 PuLGADA



CONTRATISTA

FISCALIZACIÓN

PROYECTO:

"CONSTRUCCION DE LOS HANGARES DEL GOBIERNO AUTONOMO DESCENTRALIZADO PROVINCIAL DE PASTAZA (GADPPz)-I ETAPA, PARROQUIA FÁTIMA, CANTÓN Y PROVINCIAL DE PASTAZA" (CÓDIGO: LICO-GADPPz-001-2018).

UBICACIÓN:

PROVINCIA:	PASTAZA	RUBRO :	362
CANTÓN:	PUYO	ANEXO :	1
PARROQUIA:	FÁTIMA	DESCRIPCION :	CAJETINES METALICOS OCTOGONALES MEDIANOS CON TAPA
ARCHIVO FOTOGRAFICO		FECHA:	1 DE JUNIO 2021 A 30 DE JUNIO 2021

CAJETINES METÁLICOS OCTOGONALES MEDIANOS CON TAPA

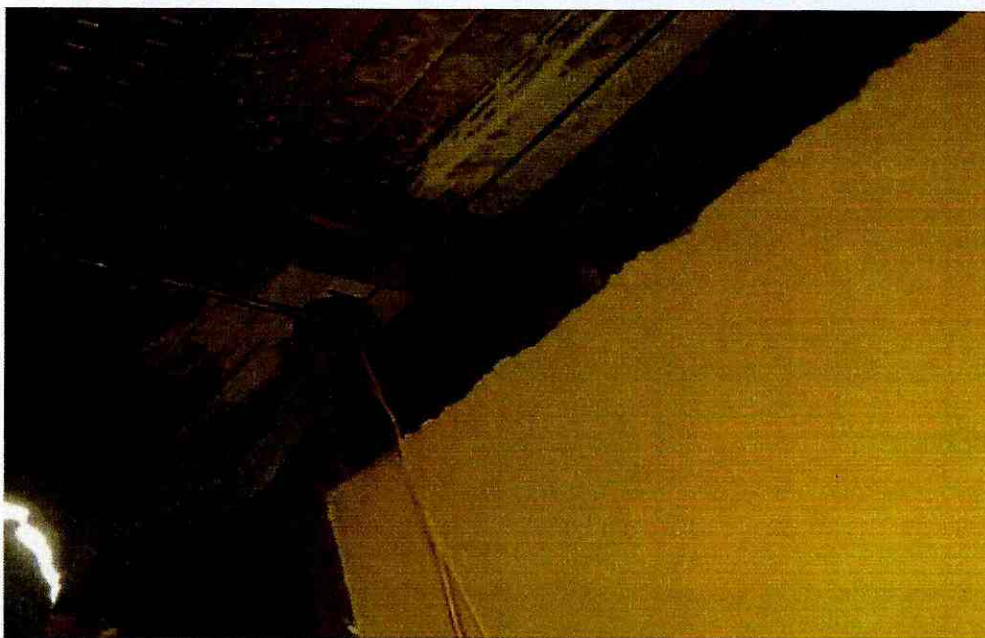

CAJETINES METÁLICOS OCTOGONALES MEDIANOS CON TAPA



CONTRATISTA



FISCALIZACIÓN

PROYECTO: "CONSTRUCCION DE LOS HANGARES DEL GOBIERNO AUTONOMO DESCENTRALIZADO PROVINCIAL DE PASTAZA (GADPPz)-I ETAPA, PARROQUIA FÁTIMA, CANTÓN Y PROVINCIAL DE PASTAZA" (CÓDIGO: LICO-GADPPz-001-2018).

UBICACIÓN:	PROVINCIA:	PASTAZA	RUBRO :	344
	CANTÓN:	PUYO	ANEXO :	1
	PARROQUIA:	FÁTIMA	DESCRIPCION :	TENDIDO DE CABLE FLEXIBLE DE COBRE NO.10 AWG COLOR AZUL (INC. TAYPE)
	ARCHIVO FOTOGRAFICO		FECHA:	1 DE JUNIO 2021 A 30 DE JUNIO 2021

TENDIDO DE CABLE FLEXIBLE DE COBRE NO.10 AWG COLOR AZUL (INC. TAYPE)

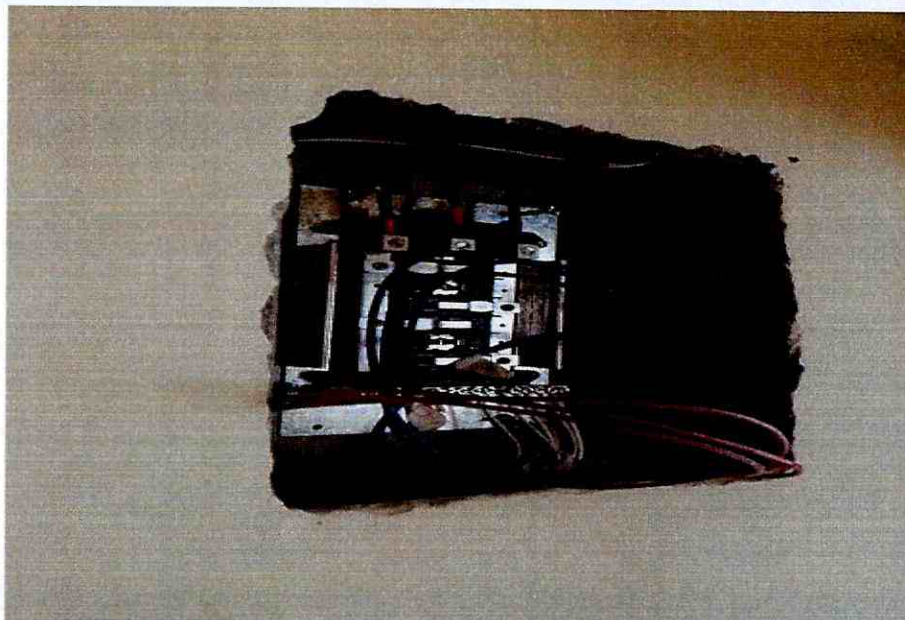

TENDIDO DE CABLE FLEXIBLE DE COBRE NO.10 AWG COLOR AZUL (INC. TAYPE)

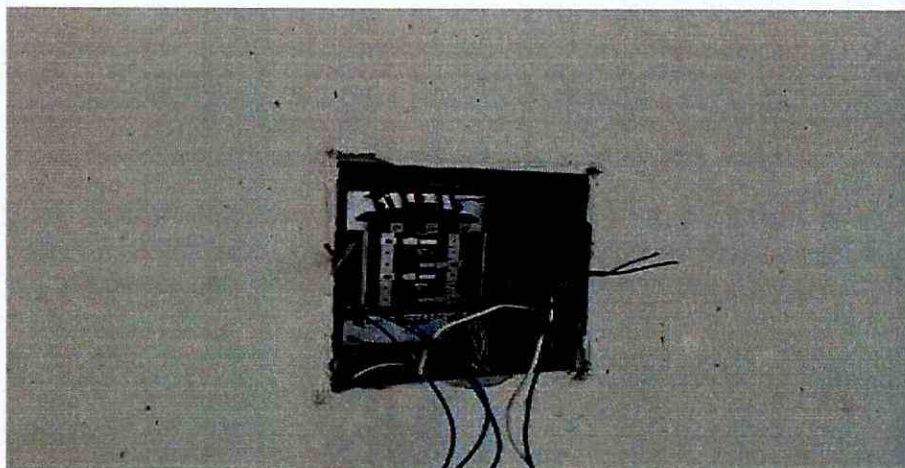

CONTRATISTA



FISCALIZACIÓN



PROYECTO:

"CONSTRUCCIÓN DE LOS HANGARES DEL GOBIERNO AUTONOMO DESCENTRALIZADO PROVINCIAL DE PASTAZA (GADPPz)-I ETAPA, PARROQUIA FÁTIMA, CANTÓN Y PROVINCIAL DE PASTAZA" (CÓDIGO: LICO-GADPPz-001-2018).

UBICACIÓN:

PROVINCIA:	PASTAZA	RUBRO :	345
CANTÓN:	PUYO	ANEXO :	1
PARROQUIA:	FÁTIMA	DESCRIPCION :	TENDIDO DE CABLE FLEXIBLE DE COBRE NO.10 AWG COLOR BLANCO (INC. TAYPE)
ARCHIVO FOTOGRAFICO		FECHA:	1 DE JUNIO 2021 A 30 DE JUNIO 2021

TENDIDO DE CABLE FLEXIBLE DE COBRE NO.10 AWG COLOR BLANCO (INC. TAYPE)

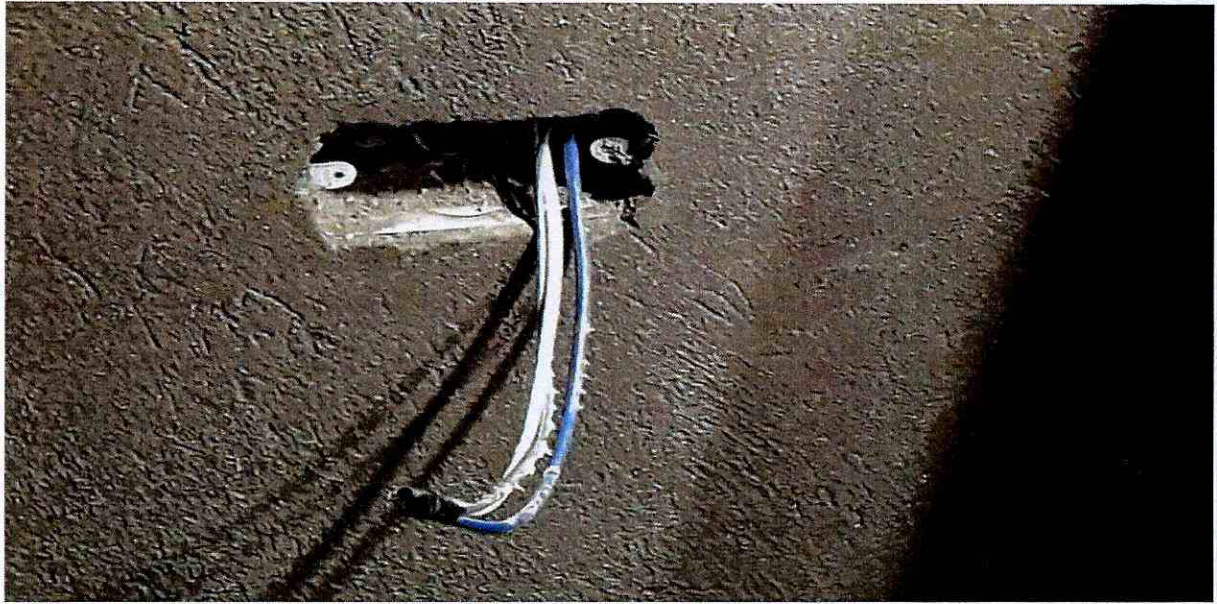

TENDIDO DE CABLE FLEXIBLE DE COBRE NO.10 AWG COLOR BLANCO (INC. TAYPE)

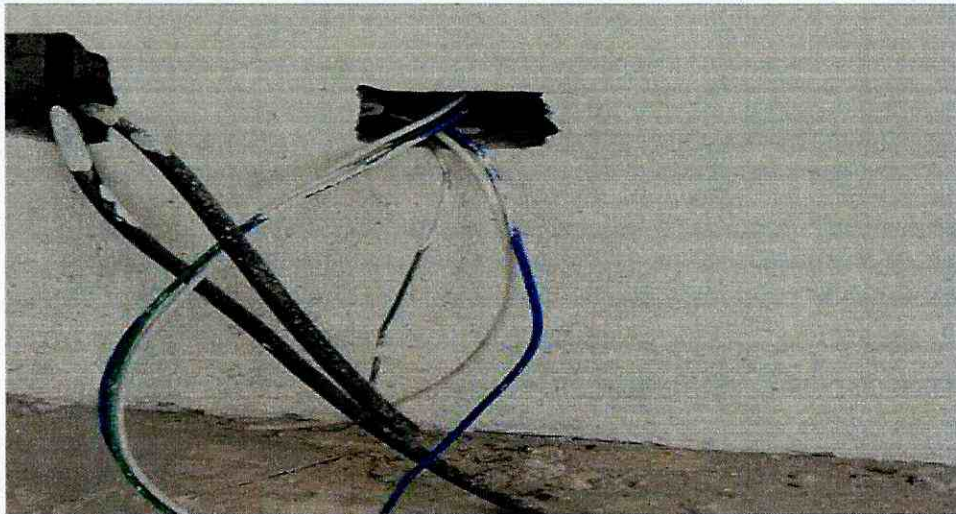

CONTRATISTA

FISCALIZACIÓN

PROYECTO:

"CONSTRUCCION DE LOS HANGARES DEL GOBIERNO AUTONOMO DESCENTRALIZADO PROVINCIAL DE PASTAZA (GADPPz)-I ETAPA, PARROQUIA FÁTIMA, CANTÓN Y PROVINCIAL DE PASTAZA" (CÓDIGO: LICO-GADPPz-001-2018).

UBICACIÓN:

PROVINCIA:	PASTAZA	RUBRO :	346
CANTÓN:	PUYO	ANEXO :	1
PARROQUIA:	FÁTIMA	DESCRIPCION :	TENDIDO DE CABLE FLEXIBLE DE COBRE NO.14 AWG COLOR VERDE (INC. TAYPE)
ARCHIVO FOTOGRÁFICO		FECHA:	1 DE JUNIO 2021 A 30 DE JUNIO 2021

TENDIDO DE CABLE FLEXIBLE DE COBRE NO.14 AWG COLOR VERDE (INC. TAYPE)



TENDIDO DE CABLE FLEXIBLE DE COBRE NO.14 AWG COLOR VERDE (INC. TAYPE)



CONTRATISTA



FISCALIZACIÓN



PROYECTO: "CONSTRUCCION DE LOS HANGARES DEL GOBIERNO AUTONOMO DESCENTRALIZADO PROVINCIAL DE PASTAZA (GADPPz)-I ETAPA, PARROQUIA FÁTIMA, CANTÓN Y PROVINCIAL DE PASTAZA" (CÓDIGO: LICO-GADPPz-001-2018).

UBICACIÓN:	PROVINCIA:	PASTAZA	RUBRO :	365
	CANTÓN:	PUYO	ANEXO :	1
	PARROQUIA:	FÁTIMA	DESCRIPCION :	TENDIDO DE CABLE FLEXIBLE DE COBRE NO.12 AWG COLOR AmARILLO (INC. TAYPE)
	ARCHIVO FOTOGRÁFICO		FECHA:	1 DE JUNIO 2021 A 30 DE JUNIO 2021

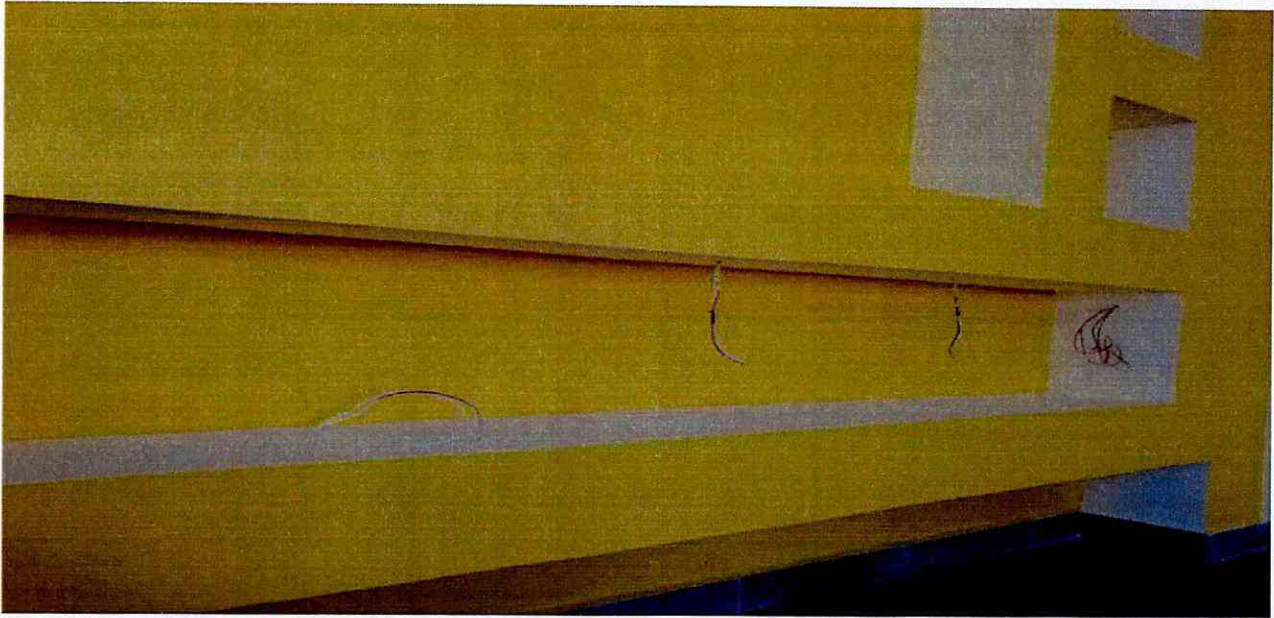
TENDIDO DE CABLE FLEXIBLE DE COBRE NO.12 AWG COLOR AmARILLO (INC. TAYPE)



TENDIDO DE CABLE FLEXIBLE DE COBRE NO.12 AWG COLOR AmARILLO (INC. TAYPE)



[Signature]

CONTRATISTA

[Signature]

FISCALIZACIÓN



PROYECTO:

"CONSTRUCCION DE LOS HANGARES DEL GOBIERNO AUTONOMO DESCENTRALIZADO PROVINCIAL DE PASTAZA (GADPPz)-I ETAPA, PARROQUIA FÁTIMA, CANTÓN Y PROVINCIAL DE PASTAZA" (CÓDIGO: LICO-GADPPz-001-2018).

UBICACIÓN:

PROVINCIA:	PASTAZA	RUBRO :	366
CANTÓN:	PUYO	ANEXO :	1
PARROQUIA:	FÁTIMA	DESCRIPCION :	TENDIDO DE CABLE FLEXIBLE DE COBRE NO.12 AWG COLOR BLANCO (INC. TAYPE)
ARCHIVO FOTOGRÁFICO		FECHA:	1 DE JUNIO 2021 A 30 DE JUNIO 2021

TENDIDO DE CABLE FLEXIBLE DE COBRE NO.12 AWG COLOR BLANCO (INC. TAYPE)

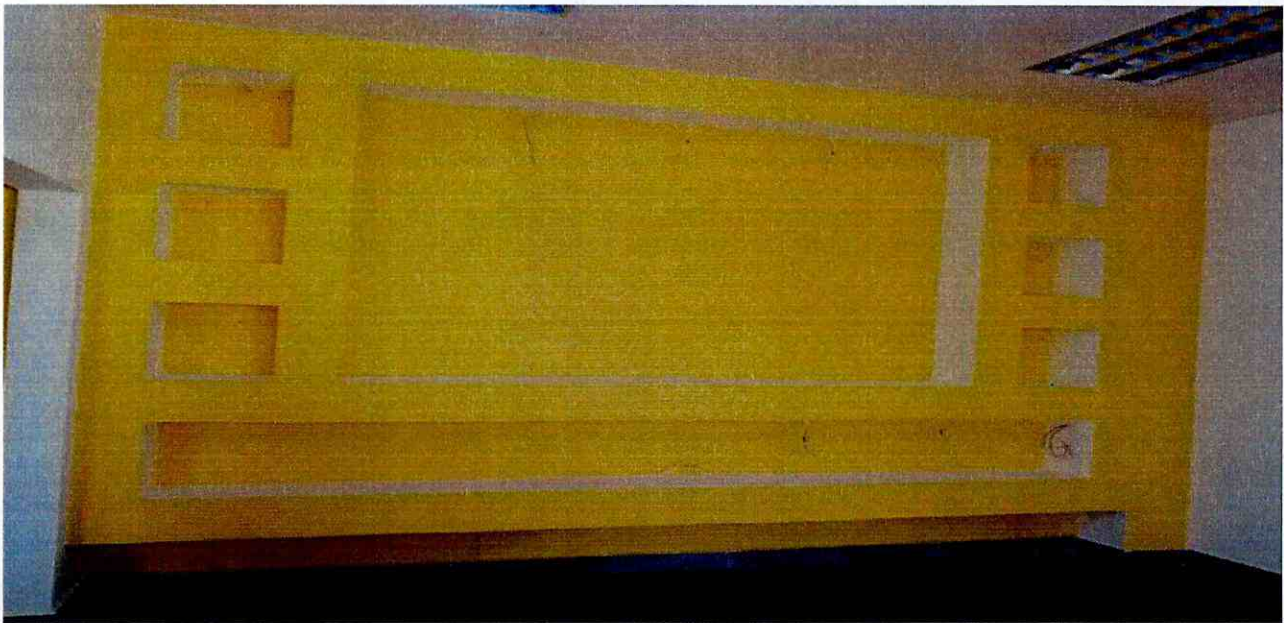

TENDIDO DE CABLE FLEXIBLE DE COBRE NO.12 AWG COLOR BLANCO (INC. TAYPE)

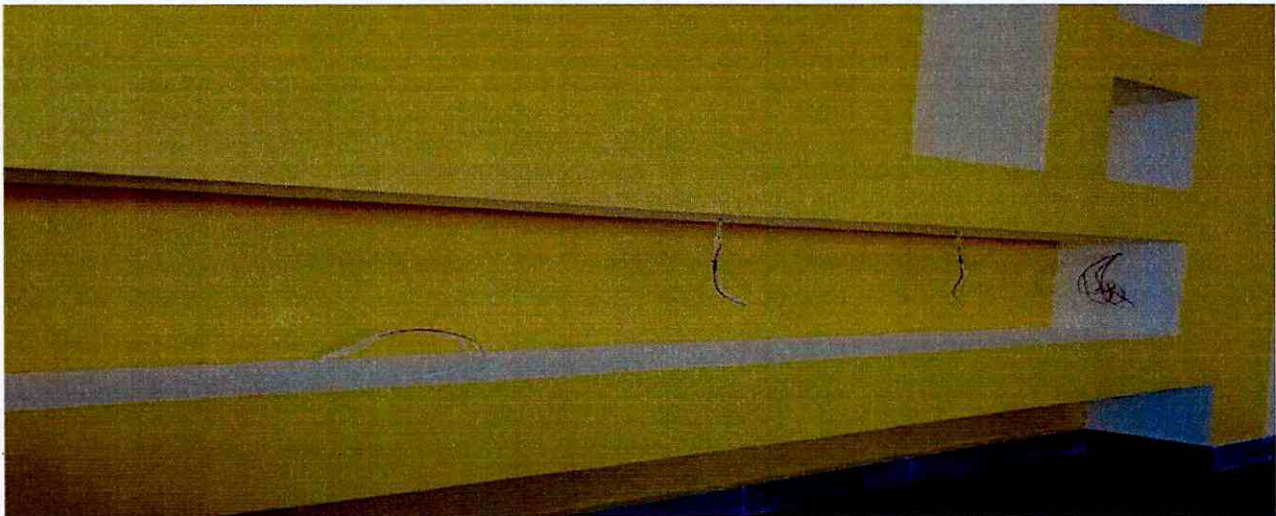

CONTRATISTA

FISCALIZACIÓN

PROYECTO:

"CONSTRUCCION DE LOS HANGARES DEL GOBIERNO AUTONOMO DESCENTRALIZADO PROVINCIAL DE PASTAZA (GADPPz)-I ETAPA, PARROQUIA FÁTIMA, CANTÓN Y PROVINCIAL DE PASTAZA" (CÓDIGO: LICO-GADPPz-001-2018).

UBICACIÓN:

PROVINCIA:	PASTAZA	RUBRO :	377
CANTÓN:	PUYO	ANEXO :	1
PARROQUIA:	FÁTIMA	DESCRIPCION :	TENDIDO DE CABLE FLEXIBLE DE COBRE NO.10 AWG COLOR AZUL (INC. TAYPE)
ARCHIVO FOTOGRÁFICO		FECHA:	1 DE JUNIO 2021 A 30 DE JUNIO 2021

TENDIDO DE CABLE FLEXIBLE DE COBRE NO.10 AWG COLOR AZUL (INC. TAYPE)

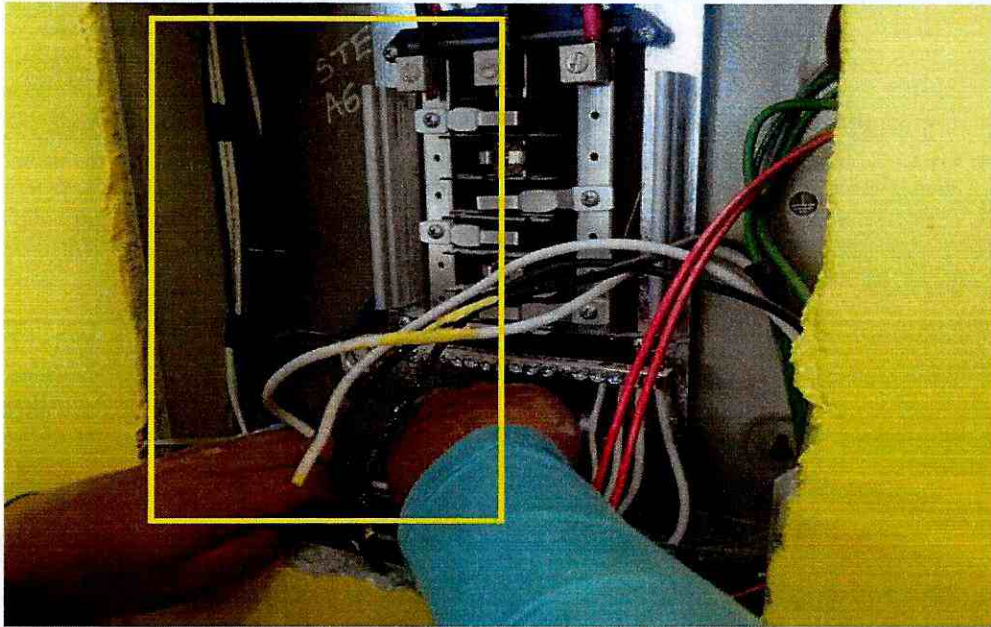

TENDIDO DE CABLE FLEXIBLE DE COBRE NO.10 AWG COLOR AZUL (INC. TAYPE)

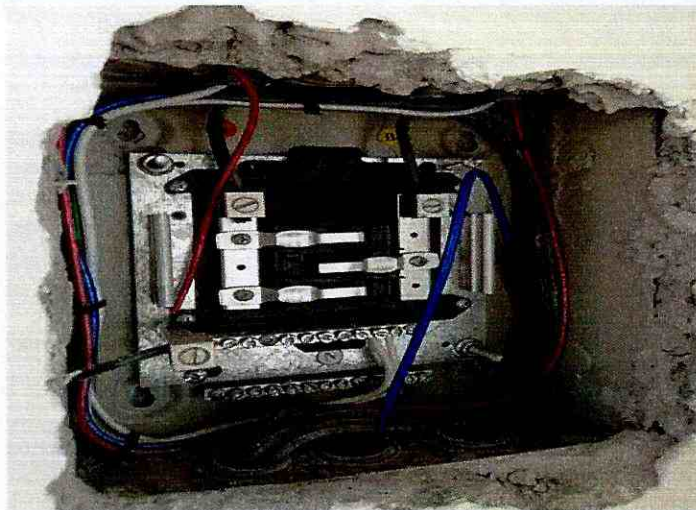

CONTRATISTA

FISCALIZACIÓN

PROYECTO:

"CONSTRUCCION DE LOS HANGARES DEL GOBIERNO AUTONOMO DESCENTRALIZADO PROVINCIAL DE PASTAZA (GADPPz)-I ETAPA, PARROQUIA FÁTIMA, CANTÓN Y PROVINCIAL DE PASTAZA" (CÓDIGO: LICO-GADPPz-001-2018).

UBICACIÓN:

PROVINCIA:	PASTAZA	RUBRO :	380
CANTÓN:	PUYO	ANEXO :	1
PARROQUIA:	FÁTIMA	DESCRIPCION :	CAJETINES mETALICOS RECTANGULARES PROFUNDOS
ARCHIVO FOTOGRAFICO	FECHA:	1 DE JUNIO 2021 A 30 DE JUNIO 2021	

CAJETINES mETALICOS RECTANGULARES PROFUNDOS



CAJETINES mETALICOS RECTANGULARES PROFUNDOS

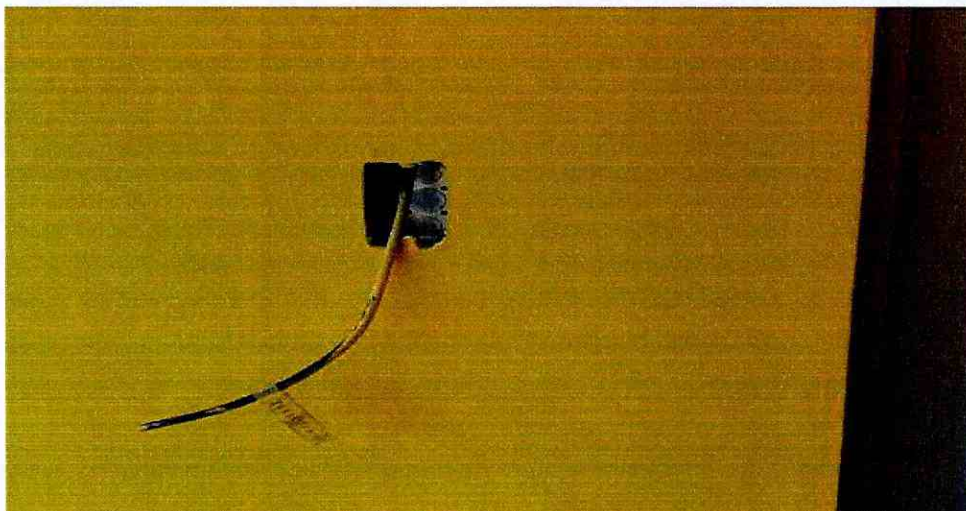

CONTRATISTA



FISCALIZACIÓN

PROYECTO:

"CONSTRUCCION DE LOS HANGARES DEL GOBIERNO AUTONOMO DESCENTRALIZADO PROVINCIAL DE PASTAZA (GADPPz)-I ETAPA, PARROQUIA FÁTIMA, CANTÓN Y PROVINCIAL DE PASTAZA" (CÓDIGO: LICO-GADPPz-001-2018).

UBICACIÓN:	PROVINCIA:	PASTAZA	RUBRO :	414
	CANTÓN:	PUYO	ANEXO :	1
	PARROQUIA:	FÁTIMA	DESCRIPCION :	TENDIDO DE CABLE CONCENTRICO 2X12 AWG(INC. TAYPE)
	ARCHIVO FOTOGRAFICO		FECHA:	1 DE JUNIO 2021 A 30 DE JUNIO 2021

TENDIDO DE CABLE CONCENTRICO 2X12 AWG(INC. TAYPE)

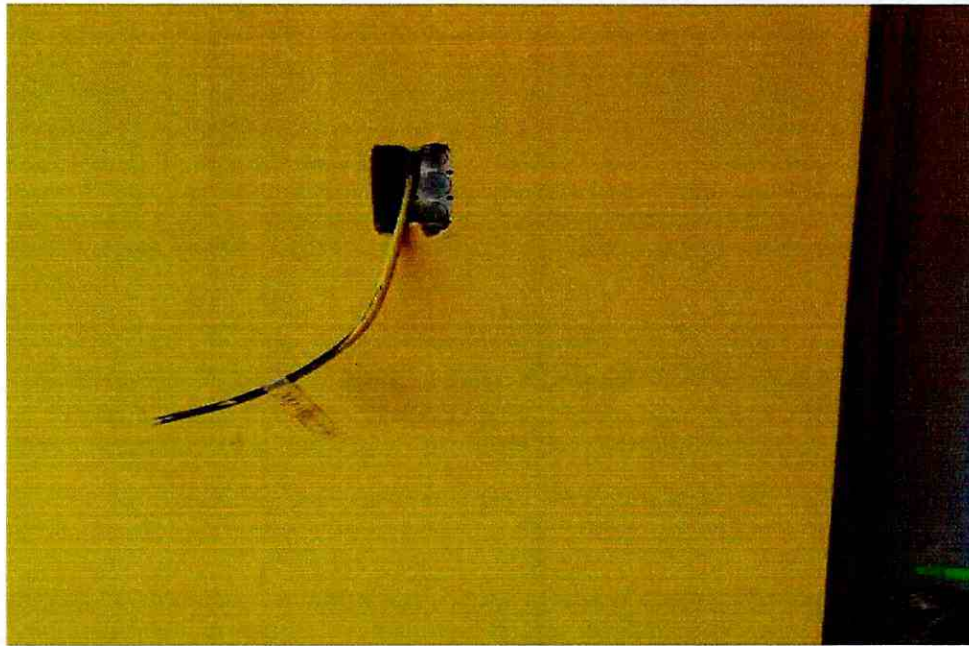

TENDIDO DE CABLE CONCENTRICO 2X12 AWG(INC. TAYPE)



L

CONTRATISTA

[Signature]

FISCALIZACIÓN



PROYECTO:

"CONSTRUCCION DE LOS HANGARES DEL GOBIERNO AUTONOMO DESCENTRALIZADO PROVINCIAL DE PASTAZA (GADPPz)-I ETAPA, PARROQUIA FÁTIMA, CANTÓN Y PROVINCIAL DE PASTAZA" (CÓDIGO: LICO-GADPPz-001-2018).

UBICACIÓN:

PROVINCIA:	PASTAZA	RUBRO :	503
CANTÓN:	PUYO	ANEXO :	1
PARROQUIA:	FÁTIMA	DESCRIPCION :	TENDIDO DE CABLE NO. 3X6+6 Cu TW (INC. TAYPE)
ARCHIVO FOTOGRAFICO		FECHA:	1 DE JUNIO 2021 A 30 DE JUNIO 2021

TENDIDO DE CABLE NO. 3X6+6 Cu TW (INC. TAYPE)

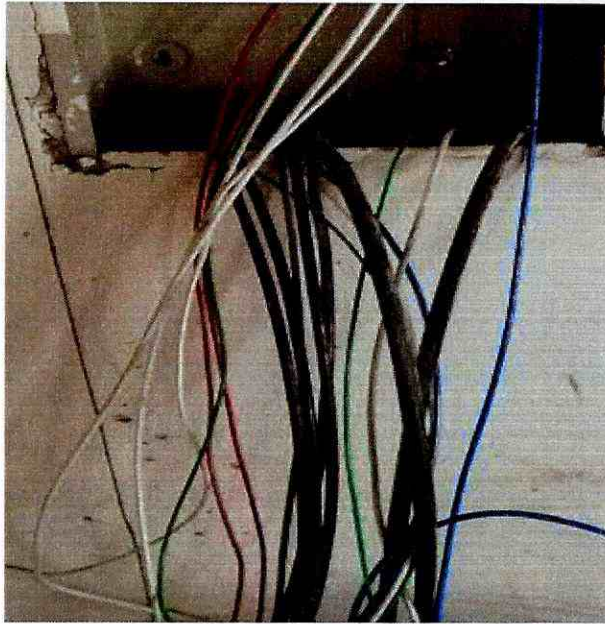

TENDIDO DE CABLE NO. 3X6+6 Cu TW (INC. TAYPE)

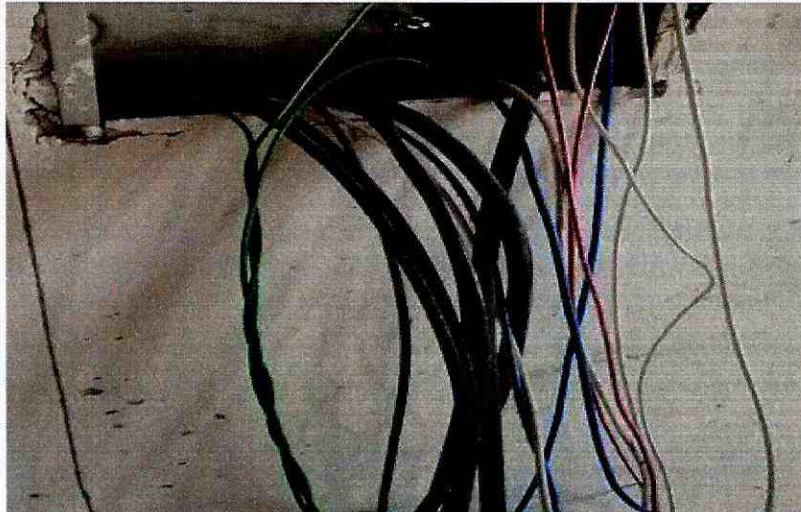

CONTRATISTA

FISCALIZACIÓN

PROYECTO:

"CONSTRUCCION DE LOS HANGARES DEL GOBIERNO AUTONOMO DESCENTRALIZADO PROVINCIAL DE PASTAZA (GADPPz)-I ETAPA, PARROQUIA FÁTIMA, CANTÓN Y PROVINCIAL DE PASTAZA" (CÓDIGO: LICO-GADPPz-001-2018).

UBICACIÓN:

PROVINCIA:	PASTAZA	RUBRO :	516
CANTÓN:	PUYO	ANEXO :	1
PARROQUIA:	FÁTIMA	DESCRIPCION :	TENDIDO DE CABLE DE COBRE NO. 1/0 THHN
ARCHIVO FOTOGRAFICO	FECHA:	1 DE JUNIO 2021 A 30 DE JUNIO 2021	

TENDIDO DE CABLE DE COBRE NO. 1/0 THHN



TENDIDO DE CABLE DE COBRE NO. 1/0 THHN



CONTRATISTA

FISCALIZACIÓN

PROYECTO:

"CONSTRUCCION DE LOS HANGARES DEL GOBIERNO AUTONOMO DESCENTRALIZADO PROVINCIAL DE PASTAZA (GADPPz)-I ETAPA, PARROQUIA FÁTIMA, CANTÓN Y PROVINCIAL DE PASTAZA" (CÓDIGO: LICO-GADPPz-001-2018).

UBICACIÓN:

PROVINCIA:	PASTAZA	RUBRO :	523
CANTÓN:	PUYO	ANEXO :	1
PARROQUIA:	FÁTIMA	DESCRIPCION :	INSTALACION DE CENTRAL ENERGIZADORA 5K
ARCHIVO FOTOGRAFICO		FECHA:	1 DE JUNIO 2021 A 30 DE JUNIO 2021

INSTALACION DE CENTRAL ENERGIZADORA 5K

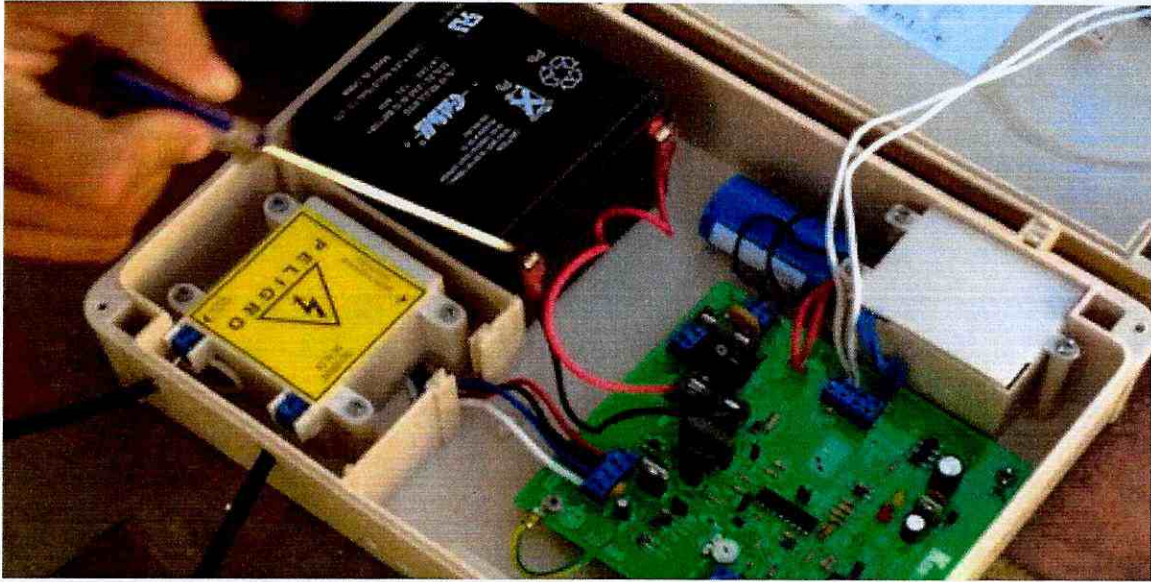

INSTALACION DE CENTRAL ENERGIZADORA 5K



CONTRATISTA



FISCALIZACIÓN

PROYECTO:

"CONSTRUCCION DE LOS HANGARES DEL GOBIERNO AUTONOMO DESCENTRALIZADO PROVINCIAL DE PASTAZA (GADPPz)-I ETAPA, PARROQUIA FÁTIMA, CANTÓN Y PROVINCIAL DE PASTAZA" (CÓDIGO: LICO-GADPPz-001-2018).

UBICACIÓN:

PROVINCIA:	PASTAZA	RUBRO :	524
CANTÓN:	PUYO	ANEXO :	1
PARROQUIA:	FÁTIMA	DESCRIPCION :	COLOCACION DE TuBERIA PREPARADA
ARCHIVO FOTOGRAFICO		FECHA:	1 DE JUNIO 2021 A 30 DE JUNIO 2021

COLOCACION DE TuBERIA PREPARADA

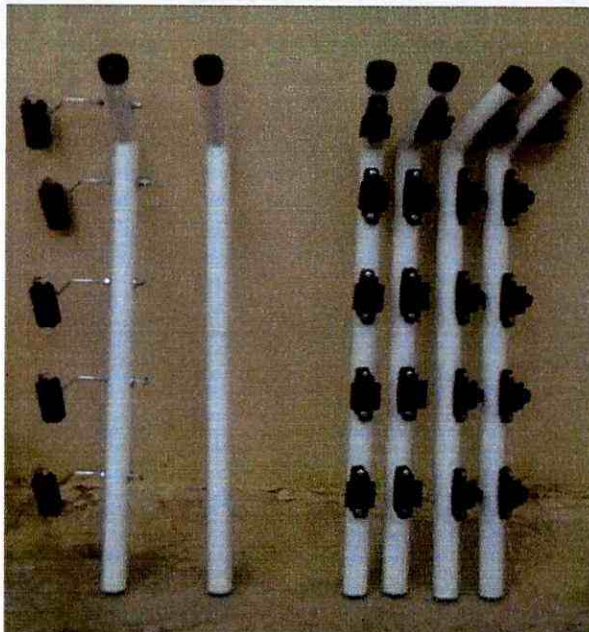

COLOCACION DE TuBERIA PREPARADA

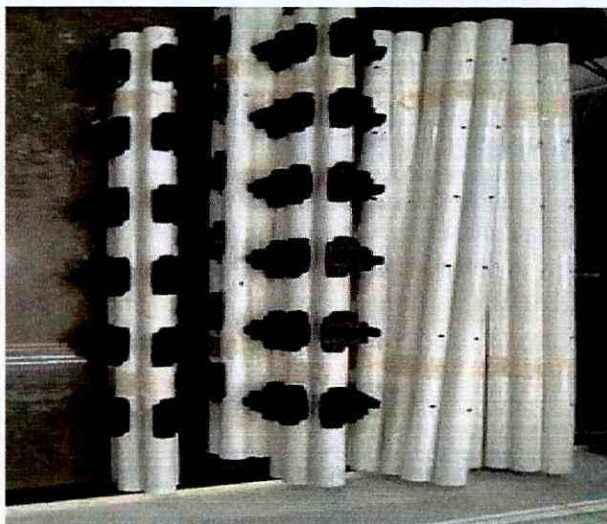

CONTRATISTA

FISCALIZACIÓN



PROYECTO:

"CONSTRUCCION DE LOS HANGARES DEL GOBIERNO AUTONOMO DESCENTRALIZADO PROVINCIAL DE PASTAZA (GADPPz)-I ETAPA, PARROQUIA FÁTIMA, CANTÓN Y PROVINCIAL DE PASTAZA" (CÓDIGO: LICO-GADPPz-001-2018).

UBICACIÓN:

PROVINCIA:	PASTAZA	RUBRO :	525
CANTÓN:	PUYO	ANEXO :	1
PARROQUIA:	FÁTIMA	DESCRIPCION :	COLOCACION DE AISLADORES DE PASO DE ESQUINA Y PASANTE
ARCHIVO FOTOGRAFICO		FECHA:	1 DE JUNIO 2021 A 30 DE JUNIO 2021

COLOCACION DE AISLADORES DE PASO DE ESQUINA Y PASANTE

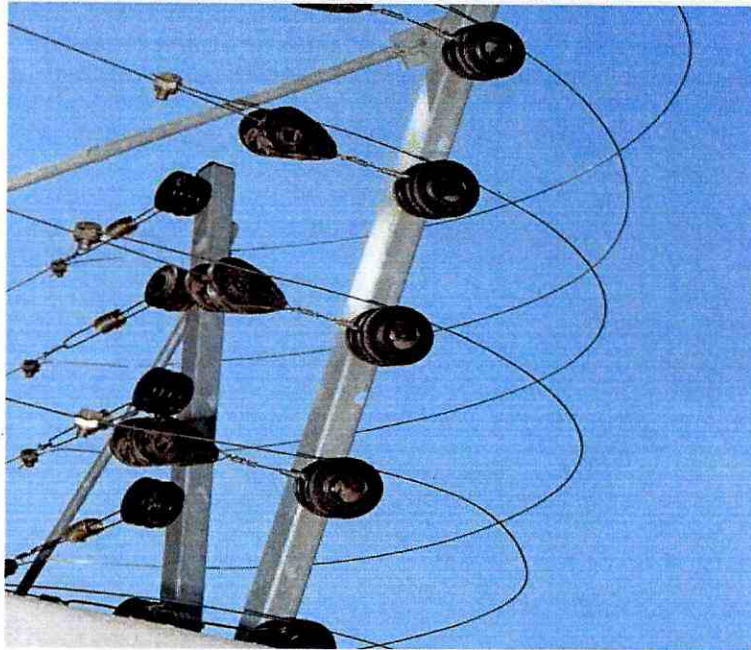

COLOCACION DE AISLADORES DE PASO DE ESQUINA Y PASANTE

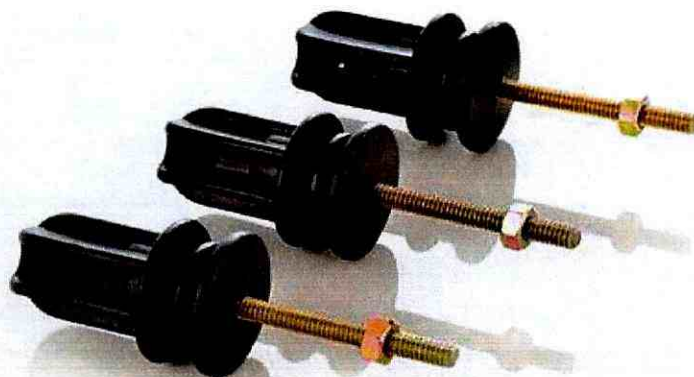

CONTRATISTA

FISCALIZACIÓN



PROYECTO:

"CONSTRUCCION DE LOS HANGARES DEL GOBIERNO AUTONOMO DESCENTRALIZADO PROVINCIAL DE PASTAZA (GADPPz)-I ETAPA, PARROQUIA FÁTIMA, CANTÓN Y PROVINCIAL DE PASTAZA" (CÓDIGO: LICO-GADPPz-001-2018).

UBICACIÓN:

PROVINCIA:	PASTAZA	RUBRO :	526
CANTÓN:	PUYO	ANEXO :	1
PARROQUIA:	FÁTIMA	DESCRIPCION :	TENDIDO DE ALAMBRE SOLIDO GALVANIZADO
ARCHIVO FOTOGRAFICO	FECHA:	1 DE JUNIO 2021 A 30 DE JUNIO 2021	

TENDIDO DE ALAMBRE SOLIDO GALVANIZADO

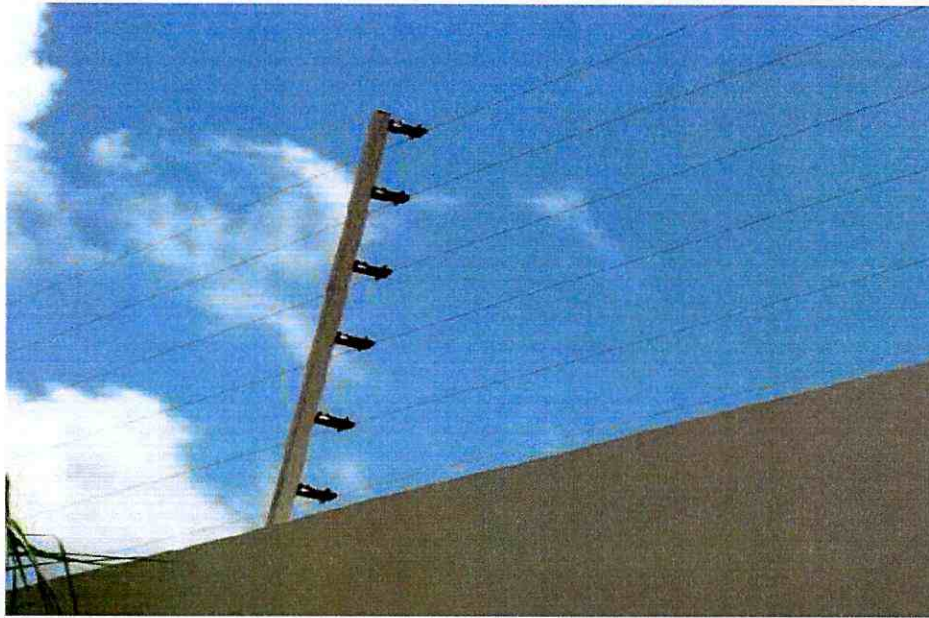

TENDIDO DE ALAMBRE SOLIDO GALVANIZADO

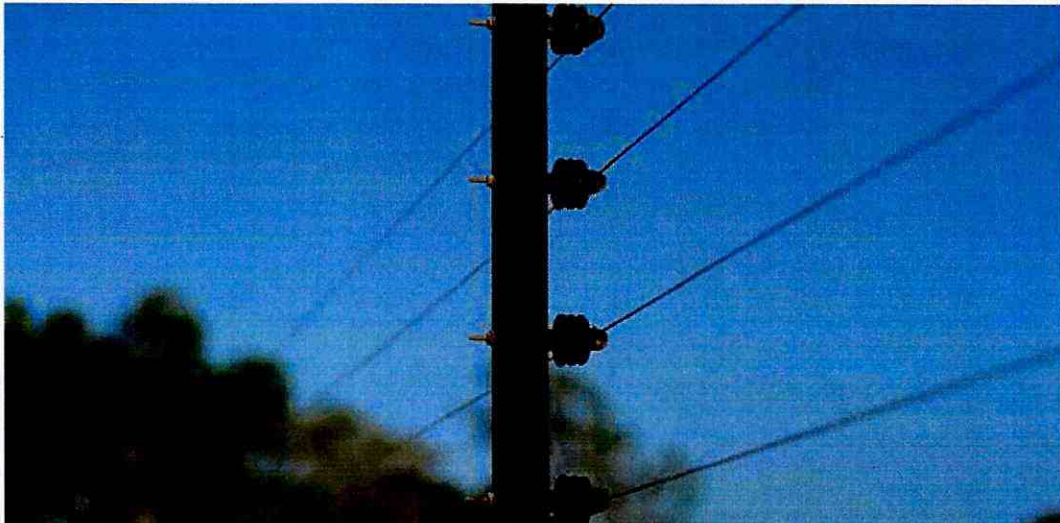

CONTRATISTA

FISCALIZACIÓN

PROYECTO:

"CONSTRUCCION DE LOS HANGARES DEL GOBIERNO AUTONOMO DESCENTRALIZADO PROVINCIAL DE PASTAZA (GADPPz)-I ETAPA, PARROQUIA FÁTIMA, CANTÓN Y PROVINCIAL DE PASTAZA" (CÓDIGO: LICO-GADPPz-001-2018).

UBICACIÓN:

PROVINCIA:	PASTAZA	RUBRO :	527
CANTÓN:	PUYO	ANEXO :	1
PARROQUIA:	FÁTIMA	DESCRIPCION :	TENDIDO DE CONDUCTOR DE COBRE DE ALTA TENSION 1/0
ARCHIVO FOTOGRAFICO	FECHA:	1 DE JUNIO 2021 A 30 DE JUNIO 2021	

TENDIDO DE CONDUCTOR DE COBRE DE ALTA TENSION 1/0



TENDIDO DE CONDUCTOR DE COBRE DE ALTA TENSION 1/0



CONTRATISTA

FISCALIZACIÓN

PROYECTO:

"CONSTRUCCION DE LOS HANGARES DEL GOBIERNO AUTONOMO DESCENTRALIZADO PROVINCIAL DE PASTAZA (GADPPz)-I ETAPA, PARROQUIA FÁTIMA, CANTÓN Y PROVINCIAL DE PASTAZA" (CÓDIGO: LICO-GADPPz-001-2018).

UBICACIÓN:

PROVINCIA:	PASTAZA	RUBRO:	528
CANTÓN:	PUYO	ANEXO:	1
PARROQUIA:	FÁTIMA	DESCRIPCION:	INSTALACIONDE BATERIA Y SIRENA
ARCHIVO FOTOGRAFICO		FECHA:	1 DE JUNIO 2021 A 30 DE JUNIO 2021

INSTALACIONDE BATERIA Y SIRENA

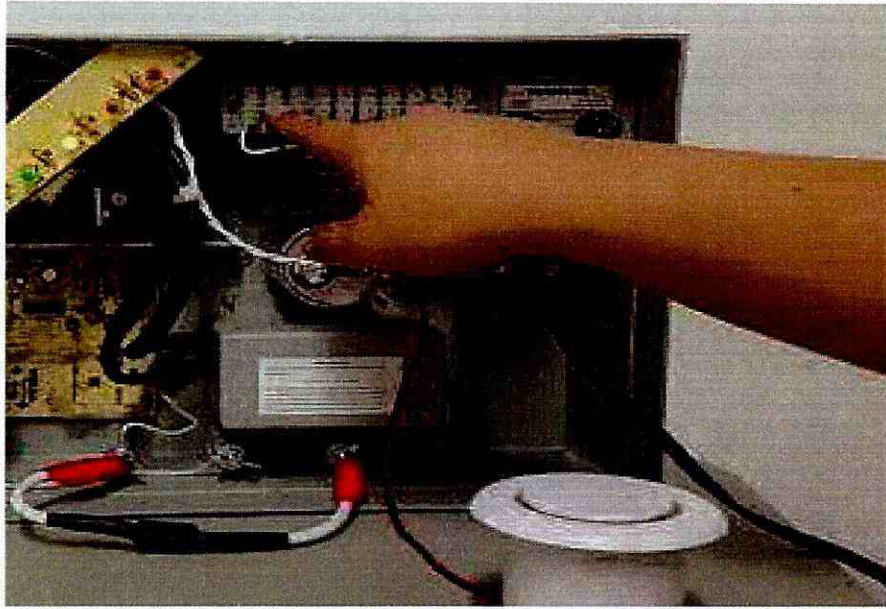

INSTALACIONDE BATERIA Y SIRENA

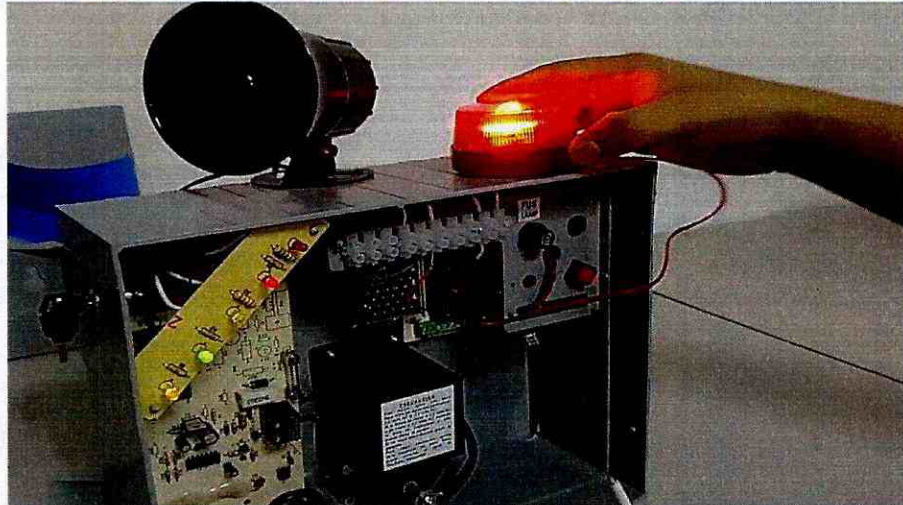

CONTRATISTA

FISCALIZACIÓN

PROYECTO:

"CONSTRUCCION DE LOS HANGARES DEL GOBIERNO AUTONOMO DESCENTRALIZADO PROVINCIAL DE PASTAZA (GADPPz)-I ETAPA, PARROQUIA FÁTIMA, CANTÓN Y PROVINCIAL DE PASTAZA" (CÓDIGO: LICO-GADPPz-001-2018).

UBICACIÓN:

PROVINCIA:	PASTAZA	RUBRO :	529
CANTÓN:	PUYO	ANEXO :	1
PARROQUIA:	FÁTIMA	DESCRIPCION :	SISTEmA DE PuESTA A TIERRA
ARCHIVO FOTOGRÁFICO		FECHA:	1 DE JUNIO 2021 A 30 DE JUNIO 2021

SISTEmA DE PuESTA A TIERRA



SISTEmA DE PuESTA A TIERRA



L

CONTRATISTA

[Signature]

FISCALIZACIÓN



PROYECTO:

"CONSTRUCCION DE LOS HANGARES DEL GOBIERNO AUTONOMO DESCENTRALIZADO PROVINCIAL DE PASTAZA (GADPPz)-I ETAPA, PARROQUIA FÁTIMA, CANTÓN Y PROVINCIAL DE PASTAZA" (CÓDIGO: LICO-GADPPz-001-2018).

UBICACIÓN:

PROVINCIA:	PASTAZA	RUBRO :	715
CANTÓN:	PUYO	ANEXO :	1
PARROQUIA:	FÁTIMA	DESCRIPCION :	BANDEJA TIPO ESCALERILLA 10CmX8Cm INCLUYE ACCESORIOS
ARCHIVO FOTOGRAFICO		FECHA:	1 DE JUNIO 2021 A 30 DE JUNIO 2021

BANDEJA TIPO ESCALERILLA 10CmX8Cm INCLUYE ACCESORIOS



BANDEJA TIPO ESCALERILLA 10CmX8Cm INCLUYE ACCESORIOS



CONTRATISTA

FISCALIZACIÓN



PROYECTO:

"CONSTRUCCION DE LOS HANGARES DEL GOBIERNO AUTONOMO DESCENTRALIZADO PROVINCIAL DE PASTAZA (GADPPz)-I ETAPA, PARROQUIA FÁTIMA, CANTÓN Y PROVINCIAL DE PASTAZA" (CÓDIGO: LICO-GADPPz-001-2018).

UBICACIÓN:

PROVINCIA:	PASTAZA	RUBRO :	750
CANTÓN:	PUYO	ANEXO:	1
PARROQUIA:	FÁTIMA	DESCRIPCION :	CABLE THHN No. 6 AWG 19H
ARCHIVO FOTOGRAFICO		FECHA:	1 DE JUNIO 2021 A 30 DE JUNIO 2021

CABLE THHN No. 6 AWG 19H



CABLE THHN No. 6 AWG 19H



CONTRATISTA

FISCALIZACIÓN

PROYECTO:

"CONSTRUCCION DE LOS HANGARES DEL GOBIERNO AUTONOMO DESCENTRALIZADO PROVINCIAL DE PASTAZA (GADPPz)-I ETAPA, PARROQUIA FÁTIMA, CANTÓN Y PROVINCIAL DE PASTAZA" (CÓDIGO: LICO-GADPPz-001-2018).

UBICACIÓN:

PROVINCIA:	PASTAZA	RUBRO :	768
CANTÓN:	PUYO	ANEXO :	1
PARROQUIA:	FÁTIMA	DESCRIPCION :	DETECTOR DE HumO FOTOELECTRICO DIRECCIONABLE
ARCHIVO FOTOGRAFICO		FECHA:	1 DE JUNIO 2021 A 30 DE JUNIO 2021

DETECTOR DE HumO FOTOELECTRICO DIRECCIONABLE

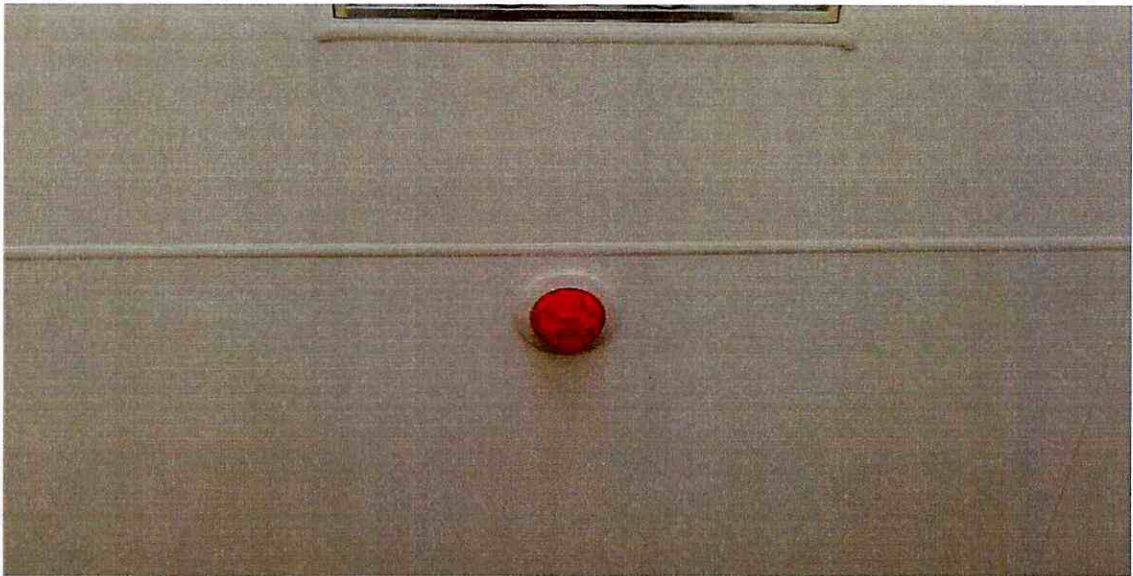

DETECTOR DE HumO FOTOELECTRICO DIRECCIONABLE

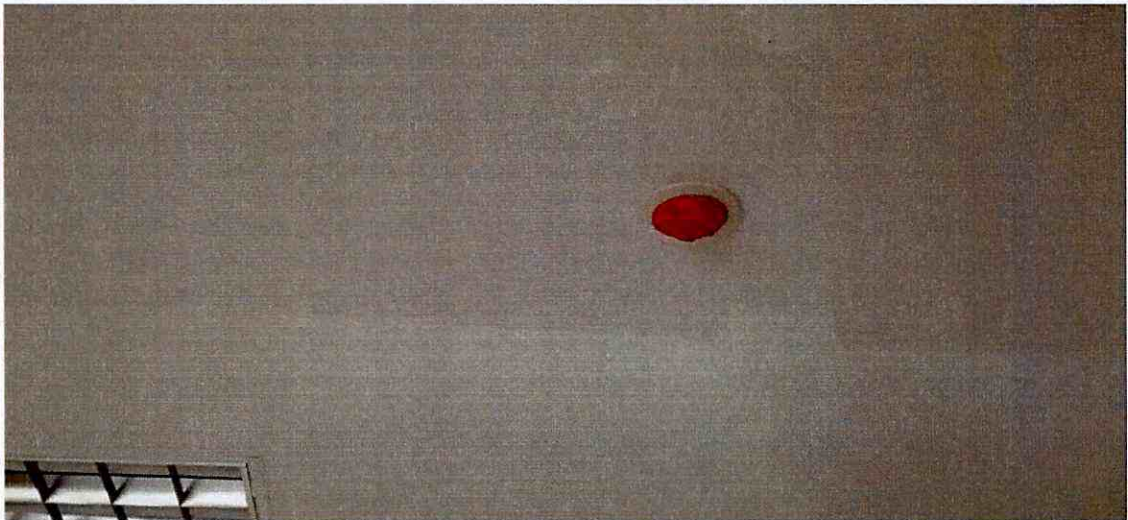

CONTRATISTA

FISCALIZACIÓN

PROYECTO:

"CONSTRUCCION DE LOS HANGARES DEL GOBIERNO AUTONOMO DESCENTRALIZADO PROVINCIAL DE PASTAZA (GADPPz)-I ETAPA, PARROQUIA FÁTIMA, CANTÓN Y PROVINCIAL DE PASTAZA" (CÓDIGO: LICO-GADPPz-001-2018).

UBICACIÓN:

PROVINCIA:	PASTAZA	RUBRO :	770
CANTÓN:	PUYO	ANEXO :	1
PARROQUIA:	FÁTIMA	DESCRIPCION :	PuNTO DE ALARmAS DE INCENDIO
ARCHIVO FOTOGRÁFICO		FECHA:	1 DE JUNIO 2021 A 30 DE JUNIO 2021

PuNTO DE ALARmAS DE INCENDIO

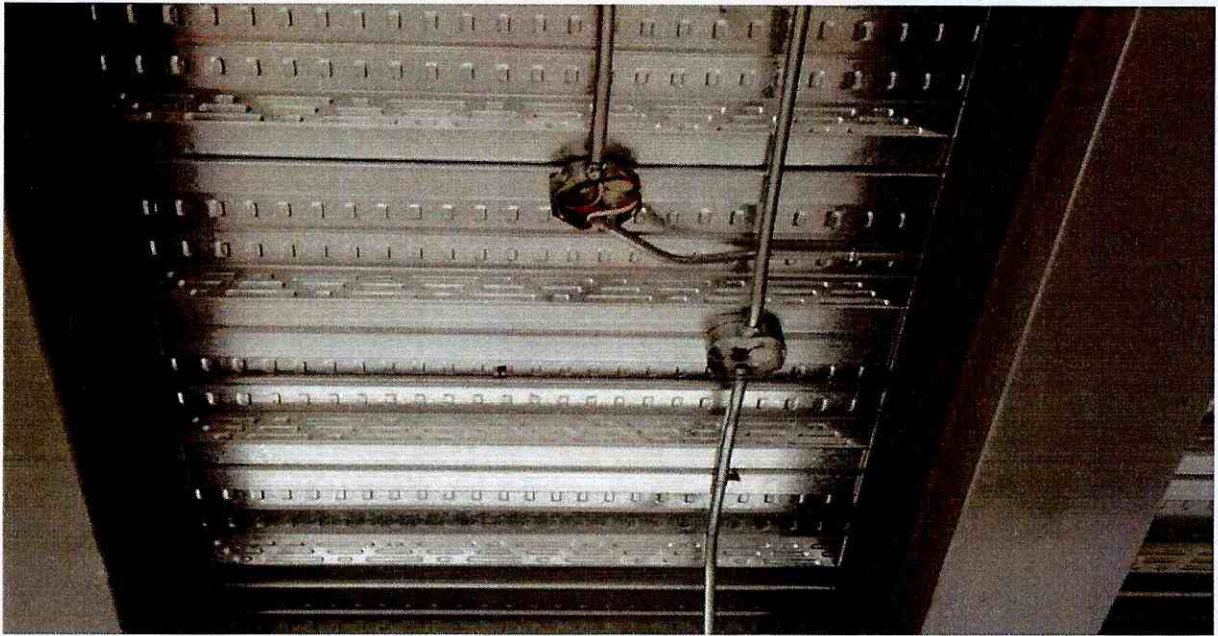

PuNTO DE ALARmAS DE INCENDIO



CONTRATISTA



FISCALIZACIÓN



PROYECTO:

"CONSTRUCCION DE LOS HANGARES DEL GOBIERNO AUTONOMO DESCENTRALIZADO PROVINCIAL DE PASTAZA (GADPPz)-I ETAPA, PARROQUIA FÁTIMA, CANTÓN Y PROVINCIAL DE PASTAZA" (CÓDIGO: LICO-GADPPz-001-2018).

UBICACIÓN:

PROVINCIA:	PASTAZA	RUBRO :	780
CANTÓN:	PUYO	ANEXO :	1
PARROQUIA:	FÁTIMA	DESCRIPCION :	CERRADuRA ELECTROmAGNETICA 600LB
ARCHIVO FOTOGRAFICO		FECHA:	1 DE JUNIO 2021 A 30 DE JUNIO 2021

CERRADuRA ELECTROmAGNETICA 600LB

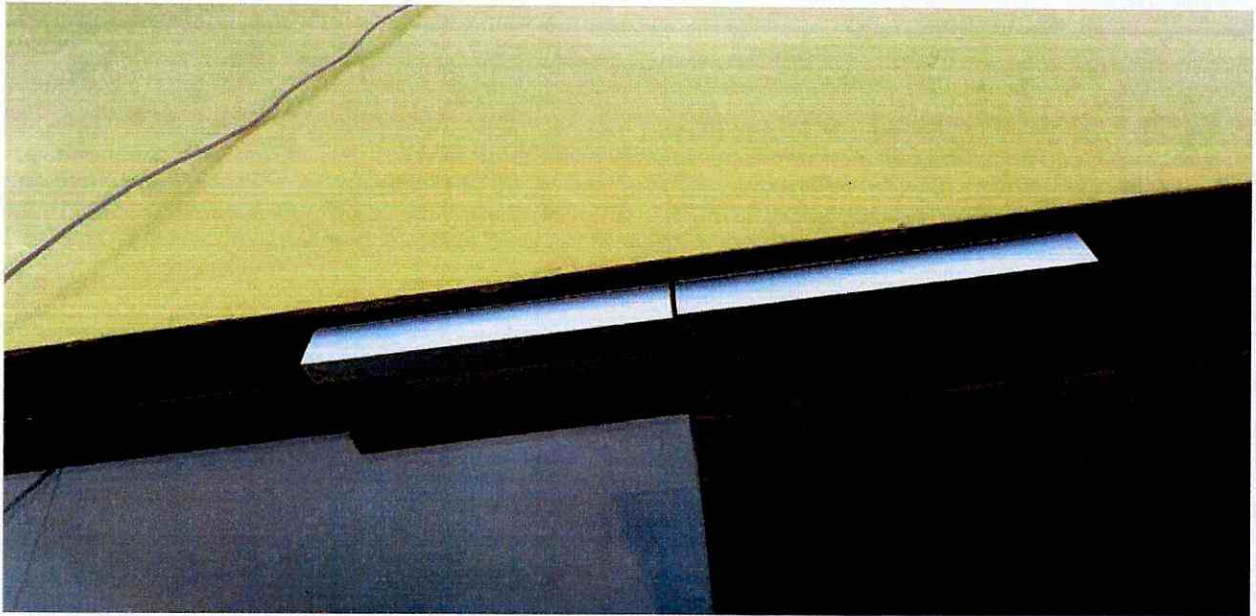

CERRADURA ELECTROmAGNETICA 600LB

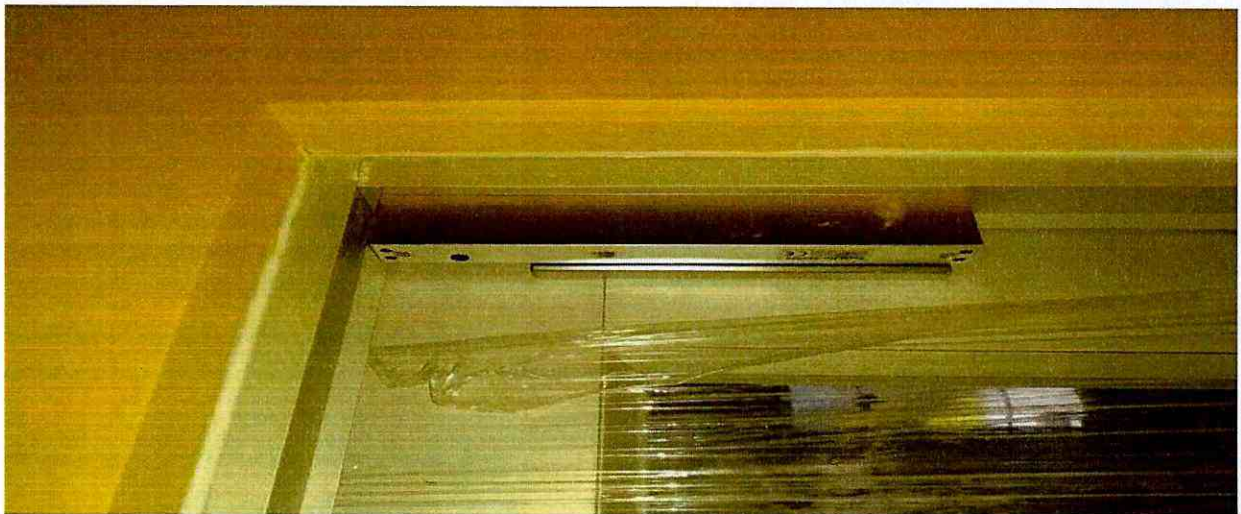

CONTRATISTA

FISCALIZACIÓN

PROYECTO:

"CONSTRUCCION DE LOS HANGARES DEL GOBIERNO AUTONOMO DESCENTRALIZADO PROVINCIAL DE PASTAZA (GADPPz)-I ETAPA, PARROQUIA FÁTIMA, CANTÓN Y PROVINCIAL DE PASTAZA" (CÓDIGO: LICO-GADPPz-001-2018).

UBICACIÓN:

PROVINCIA:	PASTAZA	RUBRO :	781
CANTÓN:	PUYO	ANEXO :	1
PARROQUIA:	FÁTIMA	DESCRIPCION :	PuLSANTE DE SALIDA PARA CONTROL DE ACCESOS
ARCHIVO FOTOGRÁFICO	FECHA:	1 DE JUNIO 2021 A 30 DE JUNIO 2021	

PuLSANTE DE SALIDA PARA CONTROL DE ACCESOS



PuLSANTE DE SALIDA PARA CONTROL DE ACCESOS

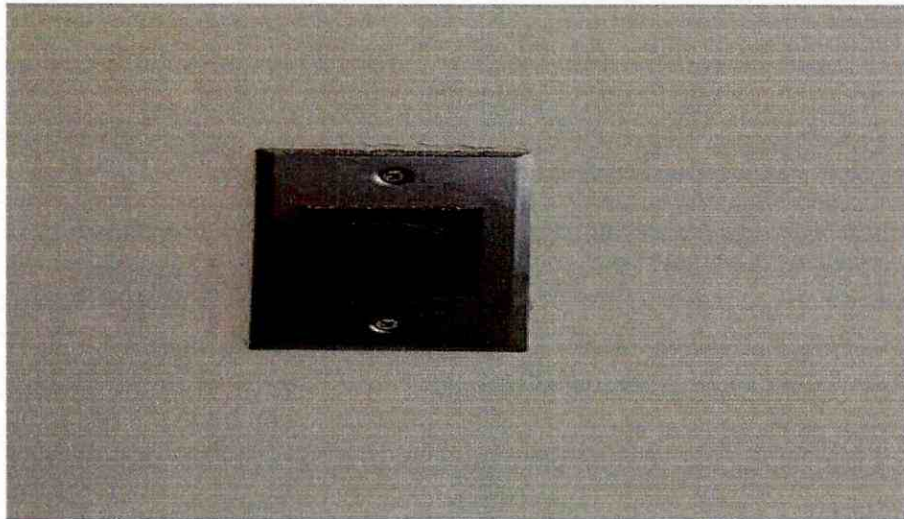

CONTRATISTA

FISCALIZACIÓN